

VARISPEED-626MC5

INSTRUCTION MANUAL

MULTI-FUNCTION ALL-DIGITAL TYPE (VS-626MC5)

MODEL: CIMR-MC5A:.....

200V CLASS 0.4 to 75kW (1.2 to 110kVA)

400V CLASS 0.4 to 75kW (1.4 to 130kVA)

Upon receipt of the product and prior to initial operation, read these instructions thoroughly, and retain for future reference.

上正科技有限公司

購買、維修 此手冊零組件

電話： 037-466333

Email: service@repairtw.com

Line id: @zzzz

www.repairtw.com



YASKAWA

MANUAL NO. TOE-S626-8

Preface

The VARISPEED-626MC5 Series of general-purpose Inverters provides V/f control and vector control as standard features along with user-friendly operation.

This manual is designed to ensure correct and suitable application of VARISPEED-626MC5-series Inverters. Read this manual before attempting to install, operate, maintain, or inspect an Inverter and keep it in a safe, convenient location for future reference. Before you understand all precautions and safety information before attempting application.

上正科技有限公司

購買、維修 此手冊零組件

電話： 037-466333

Email: service@repairtw.com

Line id: @zzzz

www.repairtw.com



Safety Information

The following conventions are used to indicate precautions in this manual. Failure to heed precautions provided in this manual can result in serious or possibly even fatal injury or damage to the products or to related equipment and systems.

 **WARNING** Indicates precautions that, if not heeded, could possibly result in loss of life or serious injury.

 **CAUTION** Indicates precautions that, if not heeded, could result in relatively serious or minor injury, damage to the product, or faulty operation.

The warning symbols for ISO and JIS standards are different, as shown below.

ISO	JIS
	

The ISO symbol is used in this manual.

Both of these symbols appear on warning labels on Yaskawa products. Please abide by these warning labels regardless of which symbol is used.

上正科技有限公司

購買、維修 此手冊零組件

電話： 037-466333

Email: service@repairtw.com

Line id: @zzzz

www.repairtw.com

Visual Aids

The following aids are used to indicate certain types of information for easier reference.



Indicates application examples.



Indicates supplemental information.



Indicates important information that should be memorized.

上正科技有限公司
購買、維修 此手冊零組件
電話： 037-466333
Email: service@repairtw.com
Line id: @zzzz
www.repairtw.com

General Precautions

- The diagrams in this manual may be indicated without covers or safety shields to show details. Be sure to restore covers or shields before operating the Units and run the Units according to the instructions described in this manual.
- Any illustrations, photographs, or examples used in this manual are provided as examples only and may not apply to all products to which this manual is applicable.
- The products and specifications described in this manual or the content and presentation of the manual may be changed without notice to improve the product and/or the manual.
- When ordering a new copy of the manual due to damage or loss, contact your Yaskawa representatives or the nearest Yaskawa sales office and provide the manual number shown on the front cover.
- If nameplates become worn or damaged, order new ones from your Yaskawa representatives or the nearest Yaskawa sales office.

上正科技有限公司

購買、維修 此手冊零組件

電話： 037-466333

Email: service@repairtw.com

Line id: @zzzz

www.repairtw.com

Safety Precautions

■ Confirmations upon Delivery

 CAUTION	
<ul style="list-style-type: none"> Never install an Inverter that is damaged or missing components. Doing so can result in injury. 	Page NO TAG

■ Installation

 CAUTION	
<ul style="list-style-type: none"> Always hold the case when carrying the Inverter. If the Inverter is held by the front cover, the main body of the Inverter may fall, possibly resulting in injury. 	Page NO TAG
<ul style="list-style-type: none"> Attach the Inverter to a metal or other noncombustible material. Fire can result if the Inverter is attached to a combustible material. 	NO TAG
<ul style="list-style-type: none"> Install a cooling fan or other cooling device when installing more than one Inverter in the same enclosure so that the temperature of the air entering the Inverters is below 45°C. Overheating can result in fires or other accidents. 	NO TAG

■ Wiring

 WARNING	
<ul style="list-style-type: none"> Always turn OFF the input power supply before wiring terminals. Otherwise, an electric shock or fire can occur. 	Page NO TAG
<ul style="list-style-type: none"> Wiring must be performed by an authorized person qualified in electrical work. Otherwise, an electric shock or fire can occur. 	NO TAG
<ul style="list-style-type: none"> Be sure to ground the ground terminal. (200 V class: Ground to 100 Ω or less, 400 V class: Ground to 10 Ω or less) Otherwise, an electric shock or fire can occur. 	NO TAG
<ul style="list-style-type: none"> Always check the operation of any emergency stop circuits after they are wired. Otherwise, there is the possibility of injury. (Wiring is the responsibility of the user.) 	NO TAG
<ul style="list-style-type: none"> Never touch the output terminals directly with your hands or allow the output lines to come into contact with the Inverter case. Never short the output circuits. Otherwise, electrical shock or grounding can occur. 	NO TAG

 CAUTION	
<ul style="list-style-type: none"> Check to be sure that the voltage of the main AC power supply satisfies the rated voltage of the Inverter. Injury or fire can occur if the voltage is not correct. 	Page NO TAG
<ul style="list-style-type: none"> Do not perform voltage withstand tests on the Inverter. Otherwise, semiconductor elements and other devices can be damaged. 	NO TAG
<ul style="list-style-type: none"> Connect braking resistors, Braking Resistor Units, and Braking Units as shown in the I/O wiring examples. Otherwise, a fire can occur. 	NO TAG
<ul style="list-style-type: none"> Tighten all terminal screws to the specified tightening torque. Otherwise, a fire may occur. 	NO TAG
<ul style="list-style-type: none"> Do not connect AC power to output terminals U, V, and W. The interior parts of the Inverter will be damaged if voltage is applied to the output terminals. 	NO TAG

 CAUTION	
<ul style="list-style-type: none"> Do not connect phase-advancing capacitors or LC/RC noise filters to the output circuits. The Inverter can be damaged or internal parts burnt if these devices are connected. Do not connect electromagnetic switches or contactors to the output circuits. If a load is connected while the Inverter is operating, surge current will cause the overcurrent protection circuit inside the Inverter to operate. 	NO TAG NO TAG

■ Setting User Constants

 CAUTION	
<ul style="list-style-type: none"> Disconnect the load (machine, device) from the motor before autotuning. The motor may turn, possibly resulting in injury or damage to equipment. Also, motor constants cannot be correctly set with the motor attached to a load. 	Page NO TAG

■ Trial Operation

 WARNING	
<ul style="list-style-type: none"> Check to be sure that the front cover is attached before turning ON the power supply. Do not remove the front cover during operation. An electric shock may occur. Do not come close to the machine when the fault reset function is used. If the alarmed is cleared, the machine may start moving suddenly. Also, design the machine so that human safety is ensured even when it is restarted. Injury may occur. Provide a separate emergency stop switch; the Digital Operator STOP Key is valid only when its function is set. Injury may occur. Reset alarms only after confirming that the RUN signal is OFF. If an alarm is reset with the RUN signal turned ON, the machine may suddenly start. Injury may occur. 	Page NO TAG NO TAG NO TAG NO TAG

 CAUTION	
<ul style="list-style-type: none"> Don't touch the radiation fins (heat sink), braking resistor, or Braking Resistor Unit. These can become very hot. Otherwise, a burn injury may occur. Be sure that the motor and machine is within the applicable ranges before starting operation. Otherwise, an injury may occur. Provide a separate holding brake if necessary. Otherwise, an injury may occur. Don't check signals while the Inverter is running. Otherwise, the equipment may be damaged. Be careful when changing inverter settings. The inverter is factory set to suitable settings. Otherwise, the equipment may be damaged. You must, however, you must set the power supply voltage jumper for 400 V class Inverters of 18.5 kW or higher (see NO TAG). 	Page NO TAG NO TAG NO TAG NO TAG

■ Maintenance and Inspection

 WARNING	Page
<ul style="list-style-type: none"> Do not touch the Inverter terminals. Some of the terminals carry high voltages and are extremely dangerous. Doing so can result in electric shock. 	NO TAG
<ul style="list-style-type: none"> Always have the protective cover in place when power is being supplied to the Inverter. When attaching the cover, always turn OFF power to the Inverter through the MCCB. Doing so can result in electric shock. 	NO TAG
<ul style="list-style-type: none"> After turning OFF the main circuit power supply, wait until the CHARGE indicator light goes out before performance maintenance or inspections. The capacitor will remain charged and is dangerous. 	NO TAG
<ul style="list-style-type: none"> Maintenance, inspection, and replacement of parts must be performed only by authorized personnel. Remove all metal objects, such as watches and rings, before starting work. Always use grounded tools. Failure to heed these warning can result in electric shock. 	NO TAG

 CAUTION	Page
<ul style="list-style-type: none"> A CMOS IC is used in the control board. Handle the control board and CMOS IC carefully. The CMOS IC can be destroyed by static electricity if touched directly. The CMOS IC can be destroyed by static electricity if touched directly. 	NO TAG
<ul style="list-style-type: none"> Do not change the wiring, or remove connectors or the Digital Operator, during operation. Doing so can result in personal injury. 	NO TAG

■ Other

 WARNING
<ul style="list-style-type: none"> Do not attempt to modify or alter the Inverter. Doing so can result in electrical shock or injury.

購買、維修 此手冊零組件

電話： 037-466333

Email: service@repairtw.com

Line id: @zzzz

www.repairtw.com

Warning Label Contents and Position

There is a warning label on the Inverter in the position shown in the following illustration. Always heed the warnings given on this label.

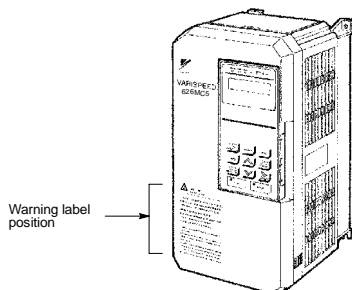

Illustration shows the CIMR-MC5A23P7

Warning Label Contents

	WARNING
<ul style="list-style-type: none">••• <p>May cause injury or electric shock.</p> <ul style="list-style-type: none">• Please follow the instructions in the manual before installation or operation.• Disconnect all power before opening front cover of unit. Wait 1 minute until DC Bus capacitors discharge.• Use proper grounding techniques.	

上正科技有限公司
購買、維修 此手冊零組件
電話：037-466333
Email: service@repairtw.com
Line id: @zzzz
www.repairtw.com

How to Change the Digital Operator Display from Japanese to English

If the Digital Operator displays messages in Japanese, change to the English mode using the following steps.

(This manual provides descriptions for the English mode.)

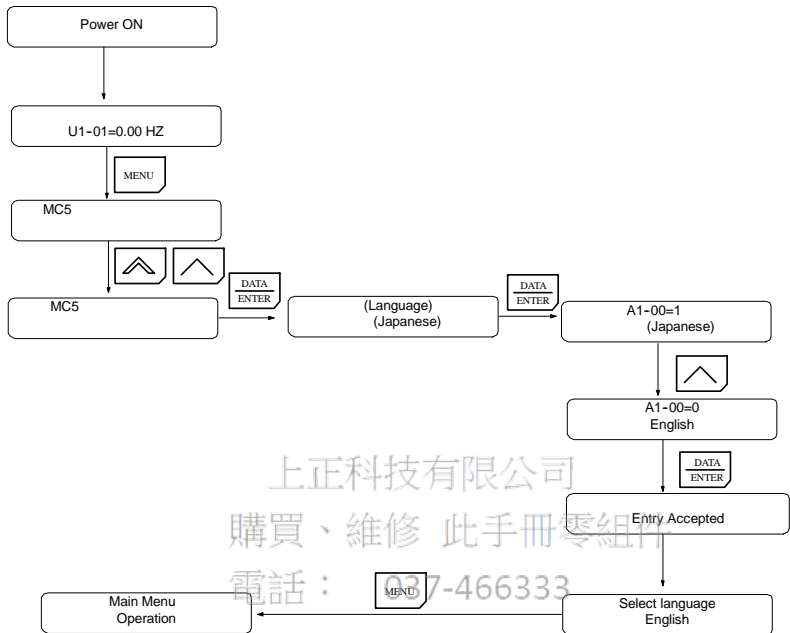

上正科技有限公司
 購買、維修 此手冊零組件
 電話： 037-466333
 Email: service@repairtw.com
 Line id: @zzzz
www.repairtw.com

Before Reading This Manual

This manual explains both the conventional VS-626MC5 Inverters and the MC5-series Inverters for SPEC: F.

The shaded sections or those specified as being for SPEC: F apply only to MC5-series Inverters for SPEC: F (Inverters with revised version letters of F or later.)

Be certain to check the specification on the Inverter nameplate.

Example of Inverter Nameplate

MODEL : CIMR-MC5A20P4 SPEC: 20P41F		
INPUT : AC 3PH	200-220 V	50Hz
	200-230 V	60Hz
OUTPUT: AC 3PH	0-230 V	1.2kVA 3.2 A
LOT NO :	MASS : 3.0kg	
SER NO :		
YASKAWA ELECTRIC CORPORATION		JAPAN

Version code

上正科技有限公司
購買、維修 此手冊零組件
電話： 037-466333
Email: service@repairtw.com
Line id: @zzzz
www.repairtw.com

CONTENTS

1 Introduction

1

2 Handling Inverters

2

3 Wiring

3

4 Setting User Constants

4

5 Trial Operation

5

6 Basic Operation

6

7 Advanced Operation

7

8 User Constants

8

9 Troubleshooting

9

10 Maintenance and Inspection

10

11 Specifications

11

12 Appendix

12

上正科技有限公司
購買、維修 此手冊零組件
電話： 037-466333

Email: service@repairtw.com
Line id: @zzzz

www.repairtw.com

Table of Contents

1	Introduction	1 - 1
1.1	Outline and Functions	1 - 2
1.1.1	VS-626MC5 Inverter Models	1 - 2
1.1.2	Outline of Control Methods	1 - 4
1.1.3	Functions	1 - 4
1.2	Nomenclature	1 - 7
1.2.1	VS-626MC5 Components	1 - 7
1.2.2	Digital Operator Components	1 - 8
2	Handling Inverters	2 - 1
2.1	Confirmations upon Delivery	2 - 2
2.1.1	Nameplate Information	2 - 2
2.2	Exterior and Mounting Dimensions	2 - 4
2.3	Checking and Controlling the Installation Site	2 - 6
2.3.1	Installation Site	2 - 6
2.3.2	Controlling the Ambient Temperature	2 - 6
2.3.3	Protecting the Inverter from Foreign Matter	2 - 6
2.4	Installation Orientation and Space	2 - 7
2.5	Removing/Attaching the Digital Operator and Front Cover	2 - 8
2.5.1	Inverters of 15 kW or Less	2 - 8
2.5.2	Inverters of 18.5 kW or Higher	2 - 9
3	Wiring	3 - 1
3.1	Connections to Peripheral Devices	3 - 3
3.2	Connection Diagram	3 - 4
3.3	Terminal Block Configuration	3 - 5
3.4	Wiring Main Circuit Terminals	3 - 6
3.4.1	Applicable Wire Sizes and Closed-loop Connectors	3 - 6
3.4.2	Main Circuit Terminal Functions	3 - 9
3.4.3	Main Circuit Configurations	3 - 10
3.4.4	Standard Connection Diagrams	3 - 12
3.4.5	Wiring the Main Circuits	3 - 13
3.5	Wiring Control Circuit Terminals	3 - 20
3.5.1	Wire Sizes and Closed-loop Connectors	3 - 20
3.5.2	Control Circuit Terminal Functions	3 - 21
3.5.3	Control Circuit Terminal Connections (All Models)	3 - 22
3.5.4	Control Circuit Wiring Precautions	3 - 23
3.6	Wiring Check	3 - 23
3.7	Installing and Wiring PG Speed Control Cards	3 - 24
3.7.1	Installing a PG Speed Control Card	3 - 24
3.7.2	PG Speed Control Card Terminal Blocks	3 - 25
3.7.3	Wiring a PG Speed Control Card	3 - 26
3.7.4	Wiring PG Speed Control Card Terminal Blocks	3 - 28
3.7.5	Selecting the Number of PG (Encoder) Pulses	3 - 30
4	Setting User Constants	4 - 1
4.1	Using the Digital Operator	4 - 2

4.2	Modes	4 - 4
4.2.1	Inverter Modes	4 - 4
4.2.2	Switching Modes	4 - 5
4.2.3	User Constant Access Levels	4 - 6
4.2.4	Operation Mode	4 - 11
4.2.5	Initialize Mode	4 - 18
4.2.6	Programming Mode	4 - 26
4.2.7	Autotuning Mode	4 - 29
4.2.8	Modified Constants Mode	4 - 31
5	Trial Operation	5 - 1
5.1	Procedure	5 - 3
5.2	Trial Operation Procedures	5 - 4
5.2.1	Power ON	5 - 4
5.2.2	Checking the Display Status	5 - 4
5.2.3	Initializing Constants	5 - 4
5.2.4	Setting Input Voltage	5 - 5
5.2.5	Autotuning	5 - 6
5.2.6	No-load Operation	5 - 8
5.2.7	Loaded Operation	5 - 9
6	Basic Operation	6 - 1
6.1	Common Settings	6 - 2
6.1.1	Setting the Access Level and Control Method: A1-01, A1-02	6 - 2
6.1.2	Frequency Reference Settings: b1-01, H3-01, H3-08, H3-09	6 - 4
6.1.3	Frequency Reference from Digital Operator: b1-01, o1-03, d1-01 to d1-09	6 - 7
6.1.4	Run Source and Sequence Input Responsiveness: b1-02, b1-06, b1-07	6 - 9
6.1.5	Acceleration/Deceleration Times: C1-01 through C1-08, C1-09, C1-10, C1-11	6 - 10
6.1.6	Prohibiting Reverse Operation: b1-04	6 - 11
6.1.7	Selecting the Stopping Method: b1-03	6 - 12
6.1.8	Multi-function Input Settings: H1-01 through H1-06	6 - 12
6.2	Open-loop Vector Control	6 - 17
6.2.1	Autotuning for general-purpose motors	6 - 17
6.2.2	Autotuning for machine tool spindle motors	6 - 18
6.2.3	Autotuning Faults	6 - 21
6.3	Flux Vector Control	6 - 22
6.3.1	PG Speed Control Card Settings	6 - 22
6.3.2	Setting the Zero-speed Operation Constants	6 - 25
6.3.3	Autotuning for general-purpose motors	6 - 27
6.3.4	Autotuning for machine tool spindle motors	6 - 29
6.3.5	Autotuning Faults	6 - 31
6.3.6	Speed Control (ASR) Structure	6 - 32
6.3.7	Speed Control (ASR) Gain	6 - 34
7	Advanced Operation	7 - 1
7.1	Open-loop Vector Control	7 - 2
7.1.1	Torque Limit Function	7 - 3
7.1.2	Adjusting Speed Feedback	7 - 5
7.1.3	Setting/Adjusting Motor Constants	7 - 5
7.1.4	Operation Selection when Output Voltage Saturated	7 - 8
7.1.5	Starting Torque Compensation Function (for SPEC: F)	7 - 9
7.2	Flux Vector Control	7 - 10
7.2.1	Torque Limit Function	7 - 11
7.2.2	Setting/Adjusting Motor Constants	7 - 12
7.2.3	Operation Selection when Output Voltage Saturated	7 - 16
7.3	Common Functions	7 - 17
7.3.1	Application Constants: b	7 - 18
7.3.2	Tuning Constants: C	7 - 21
7.3.3	Reference Constants: d	7 - 24
7.3.4	Option Constants: F	7 - 26

7.3.5	External Terminal Functions: H	7 - 31
7.3.6	Protective Functions: L	7 - 48
7.3.7	Operator Constants: o	7 - 60
7.4	Optional Functions	7 - 64
7.4.1	Winding Change Function	7 - 64
7.4.2	Wiring for Winding Change	7 - 66
7.4.3	Setting/Adjusting the Winding Change Constants	7 - 69
8	User Constants	8 - 1
8.1	Initialize Mode Constants	8 - 3
8.2	Programming Mode Constants	8 - 4
8.2.1	Application Constants: b	8 - 4
8.2.2	Autotuning Constants: C	8 - 7
8.2.3	Reference Constants: d	8 - 12
8.2.4	Motor Constant Constants: E	8 - 14
8.2.5	Options Constants: F	8 - 18
8.2.6	Terminal Constants: H	8 - 21
8.2.7	Protection Constants: L	8 - 26
8.2.8	Operator Constants: o	8 - 32
8.2.9	Winding Change Constants: P	8 - 34
8.2.10	Factory Settings that Change with the Control Method (A1-02)	8 - 35
8.2.11	Factory Settings that Change with the Inverter Capacity (o2-04)	8 - 36
9	Troubleshooting	9 - 1
9.1	Protective and Diagnostic Functions	9 - 2
9.1.1	Fault Detection	9 - 2
9.1.2	Minor Fault Detection	9 - 6
9.1.3	Operation Errors	9 - 8
9.2	Troubleshooting	9 - 9
9.2.1	If Constant Constants Cannot Be Set	9 - 9
9.2.2	If the Motor Does Not Operate	9 - 9
9.2.3	If the Direction of the Motor Rotation is Reversed	9 - 11
9.2.4	If the Motor Does Not Put Out Torque or If Acceleration is Slow	9 - 11
9.2.5	If the Motor Does Not Operate According to Reference	9 - 11
9.2.6	If the Slip Compensation Function Has Low Speed Precision	9 - 11
9.2.7	If There is Low Speed Control Accuracy at High-speed Rotation in Open-loop Vector Control Mode	9 - 11
9.2.8	If Motor Deceleration is Slow	9 - 12
9.2.9	If the Motor Overheats	9 - 12
9.2.10	If There is Noise When the Inverter is Started or From an AM Radio	9 - 12
9.2.11	If the Ground Fault Interrupter Operates When the Inverter is Run	9 - 13
9.2.12	If There is Mechanical Oscillation	9 - 13
9.2.13	If the Motor Rotates Even When Inverter Output is Stopped	9 - 13
9.2.14	If 0 V is Detected When the Fan is Started, or Fan Stalls	9 - 13
9.2.15	If Output Frequency Does Not Rise to Frequency Reference	9 - 14
9.2.16	Winding change error has occurred	9 - 14
10	Maintenance and Inspection	10 - 1
10.1	Maintenance and Inspection	10 - 3
10.1.1	Daily Inspection	10 - 3
10.1.2	Periodic Inspection	10 - 3
10.1.3	Periodic Maintenance of Parts	10 - 3
11	Specifications	11 - 1
11.1	Standard Inverter Specifications	11 - 2
11.2	Specifications of Options and Peripheral Devices	11 - 6
12	Appendix	12 - 1
12.1	Inverter Application Precautions	12 - 2

12.1.1	Selection	12 - 2
12.1.2	Installation	12 - 2
12.1.3	Settings	12 - 3
12.1.4	Handling	12 - 3
12.2	Motor Application Precautions	12 - 4
12.2.1	Using the Inverter for an Existing Standard Motor	12 - 4
12.2.2	Using the Inverter for Special Motors	12 - 5
12.2.3	Power Transmission Mechanism (Speed Reducers, Belts, and Chains)	12 - 5
12.3	Peripheral Device Application Precautions	12 - 6
12.4	Wiring Examples	12 - 8
12.4.1	Using a Braking Resistor Unit	12 - 8
12.4.2	Using a Braking Unit and Braking Resistor Unit	12 - 8
12.4.3	Using Two Braking Units in Parallel	12 - 11
12.4.4	Using Three Braking Resistor Units in Parallel	12 - 12
12.4.5	Using a JVOP-95-□, -96-□ VS Operator	12 - 13
12.4.6	Using an Open-collector Transistor for Operation Signals	12 - 14
12.4.7	Using Open-collector, Contact Outputs	12 - 14
12.5	User Constants	12 - 15

上正科技有限公司

購買、維修 此手冊零組件

電話： 037-466333

Email: service@repairtw.com

Line id: @zzzz

www.repairtw.com

1

Introduction

This chapter provides an overview of the VS-626MC5 Inverter and describes its functions and components.

1.1 Outline and Functions	1 - 2
1.1.1 VS-626MC5 Inverter Models	1 - 2
1.1.2 Outline of Control Methods	1 - 4
1.1.3 Functions	1 - 4
1.2 Nomenclature	1 - 7
1.2.1 VS-626MC5 Components	1 - 7
1.2.2 Digital Operator Components	1 - 8

上正科技有限公司

購買、維修 此手冊零組件

電話： 037-466333

Email: service@repairtw.com

Line id: @zzzz

www.repairtw.com

1.1 Outline and Functions

The VS-626 MC5 Inverter is a compact spindle drive specially designed for machine tool application. MC5 Inverter has features such as winding change during operation, and autotuning function for dual winding motors.

The VS-626MC5 Inverters provides full-current vector control based on advanced control logic. An autotuning function is included for easy vector control.

The Digital Operator provides a liquid crystal display that is 2 lines by 16 characters in size. User constant settings and monitor items are easily read in interactive operations in either Japanese or English. (The display language can be changed by setting a user constant.)

1.1.1 VS-626MC5 Inverter Models

VS-626MC5 Inverters are available in 200 and 400 V class models. These are listed in the following table. A total of 32 models is available for motor capacities of 0.4 to 75 kW.

Table 1.1 VS-626MC5 Inverter Models

Voltage Class	Maximum Applicable Motor Output [kW]	VS-626MC5		Inverter Specifications (Specify all required standards when ordering.)		
		Output Capacity [kVA]	Model Number	Open Chassis Type (IEC IP 00) CIMR-MC5A	Enclosed Wall-mounted Type (IEC IP 20, NEMA 1) CIMR-MC5A	
200 V class	0.4	1.2	CIMR-MC5A20P4	Remove the top and bottom covers from the models listed at the right. *	20P41 *	
	0.75	2.3	CIMR-MC5A20P7		20P71 *	
	1.5	3.0	CIMR-MC5A21P5		21P51 *	
	2.2	4.2	CIMR-MC5A22P2		22P21 *	
	3.7	6.7	CIMR-MC5A23P7		23P71 *	
	5.5	9.5	CIMR-MC5A25P5		25P51 *	
	7.5	13	CIMR-MC5A27P5		27P51 *	
	11	19	CIMR-MC5A2011		20111 *	
	15	24	CIMR-MC5A2015		20151 *	
	18.5	30	CIMR-MC5A2018		20180 *	20181 ‡
	22	37	CIMR-MC5A2022		20220 *	20221 ‡
	30	50	CIMR-MC5A2030		20300 †	20301 ‡
	37	61	CIMR-MC5A2037		20370 †	20371 ‡
	45	70	CIMR-MC5A2045		20450 †	20451 ‡
	55	85	CIMR-MC5A2055		20550 †	20551 ‡
	75	110	CIMR-MC5A2075		20750 †	20751 ‡
400 V class	0.4	1.4	CIMR-MC5A40P4	Remove the top and bottom covers from the models listed at the right. *	40P41 *	
	0.75	2.6	CIMR-MC5A40P7		40P71 *	
	1.5	3.7	CIMR-MC5A41P5		41P51 *	
	2.2	4.7	CIMR-MC5A42P2		42P21 *	
	3.7	6.1	CIMR-MC5A43P7		43P71 *	
	5.5	11	CIMR-MC5A45P5		45P51 *	
	7.5	14	CIMR-MC5A47P5		47P51 *	
	11	21	CIMR-MC5A4011		40111 *	
	15	26	CIMR-MC5A4015		40151 *	
	18.5	31	CIMR-MC5A4018		40180 *	40181 ‡
	22	37	CIMR-MC5A4022		40220 *	40221 ‡
	30	50	CIMR-MC5A4030		40300 *	40301 ‡
	37	61	CIMR-MC5A4037		40370 *	40371 ‡
	45	73	CIMR-MC5A4045		40450 *	40451 ‡
	55	98	CIMR-MC5A4055		40550 †	40551 ‡
	75	130	CIMR-MC5A4075		40750 †	40751 ‡

*: Immediate delivery

†: Available from factory

‡: Manufactured upon order

1.1.2 Outline of Control Methods

The VS-626MC5 uses two control methods.

- Open-loop vector control (factory setting)
- Flux vector control

PG stands for pulse generator (encoder).

Vector control is a method for removing interference with magnetic flux and torque, and controlling torque according to references.

Current vector control independently controls magnetic flux current and torque current by simultaneously controlling the motor primary current and phases. This ensures smooth rotation, high torque, and accurate speed/torque control at low speeds.

If the motor constants required for vector control are not known, the motor constants can be automatically set with autotuning.

The control methods are effective for the following applications:

- Open-loop vector control: General variable-speed drive.
- Flux vector control: Simple servodrive, high-precision speed control/torque control.

The control characteristics for each mode are shown in *Table 1.2*.

Table 1.2 Control Method Characteristics

Characteristic	Vector Control	
	Open-loop	Flux Vector
Speed Control Range	1:100	1:1000
Speed Control Precision	0.2 %	0.02 %
Initial Drive	150% at 1 Hz	150% at 0 r/min

1.1.3 Functions

■ Autotuning

Autotuning is effective for vector control. It solves problems in applicable motor restrictions and difficult constant settings. The motor constants are automatically set by entering a value from the motor's rating nameplate.

Autotuning allows flux vector control to operate accurately with virtually any normal AC induction motor, regardless of the supplier.

Always perform autotuning for motor unit separately before vector control operation.

■ Frequency References

The following five types of frequency references can be used to control the output frequency of the Inverter.

- Numeric input from the Digital Operator
- Voltage input within a range from 0 to 10 V
- Voltage input within a range from 0 to ± 10 V (with negative voltages, rotation is in the opposite direction from the run command.)
- Current input within a range from 4 to 20 mA
- Input from Option Card

Any of the above frequency references can be used by setting a constant.

A maximum of nine frequency references can be registered with the Inverter. With remote multi-step speed reference inputs, the Inverter can operate in multi-step speed operation with a maximum of nine speed steps.

■ Low Noise

The output transistor of the Inverter is an IGBT (insulated gate bipolar transistor). Using sine-wave PWM with a high-frequency carrier, the motor does not generate metallic noise.

■ Monitor Function

The following items can be monitored with the Digital Operator: Frequency reference, output frequency, output current, motor speed, output voltage reference, main-circuit DC voltage, output power, torque reference, status of input terminals, status of output terminals, operating status, total operating time, software number, speed deviation value, PID feedback value, fault status, fault history, etc.

All types of data can be monitored even with multi-function analog output.

■ Bilingual Digital Operator

The Digital Operator can display either English or Japanese. The Digital Operator's liquid crystal display provides a 16-character x 2-line display area.

Easy-to-read displays allow the advanced functions of the Inverter to be set in interactive operations to input constants, monitoring items, etc. Change the constant setting to select the English display.

■ Harmonic Countermeasures (0.4 to 160 kW Models)

The VS-626MC5 Inverters support DC reactors to easily handle high-frequency control guidelines.

- DC reactors (optional) can be connected to 0.4 to 15 kW models.
- Models from 18.5 to 75 kW have a built-in DC reactor.

■ User Constant Structure and Three Access Levels

The VS-626MC5 has a number of user constants for setting various functions. These user constants are classified into a hierarchy to make them easier to use.

The levels are as follows from top to bottom: Modes, Groups, Functions, and Constants. The access levels for the user constants are shown in *Table 1.3*.

Table 1.3 Access Levels for User Constants

Level	Contents
Mode	Classified according to operation Operation: For operating the Inverter. (All kinds of monitoring are possible.) Initialize: For selecting the language displayed at the Digital Operator, setting access levels, initialization, and the control modes. Programming: For setting user constants for operation. Autotuning: For automatic calculation or setting motor constants. (Only under the vector control mode.) Modified constants: For referencing or changing user constants after shipping.
Groups	Classified by application.
Functions	Classified by function. See user constants.
Constants	Individual user constant settings.

The VS-626MC5 allows the following three access levels to be set in order to further simplify setting user constants. (An access level is a range of user constants that can be referenced or set.)

Quick-Start	Reads/sets user constants required for trial operation. [Factory setting]
Basic	Reads/sets user constants that are commonly used.
Advanced	Reads/sets all the user constants that can be used.

Email: service@repairtw.com

Line id: @zzzz

www.repairtw.com

In general, press the DATA/ENTER Key to move from an upper to a lower level. This varies somewhat, however, according to the access level, as shown in Fig. 1.1. For the Quick-Start access level, which has few user constants that can be set, pressing the DATA/ENTER Key jumps directly to the user constant level; whereas for the Advanced access level, which has many user constants, pressing the DATA/ENTER Key first leads to the Group level.

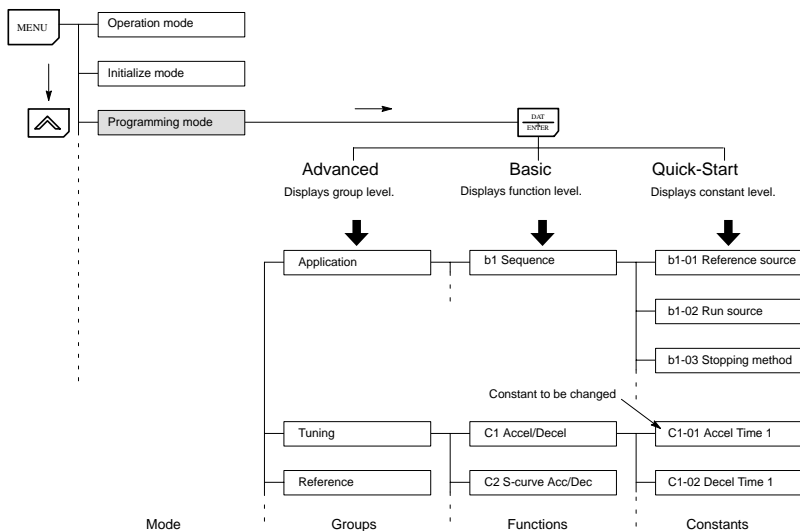

Fig 1.1 Access Level Structure

上正科技有限公司

購買、維修 此手冊零組件

電話： 037-466333

Email: service@repairtw.com

Line id: @zzzz

www.repairtw.com

1.2 Nomenclature

This section provides the names of VS-626MC5 components, and the components and functions of the Digital Operator.

1.2.1 VS-626MC5 Components

The appearance of Inverter and the names of its components are shown in *Figure 1.2*.

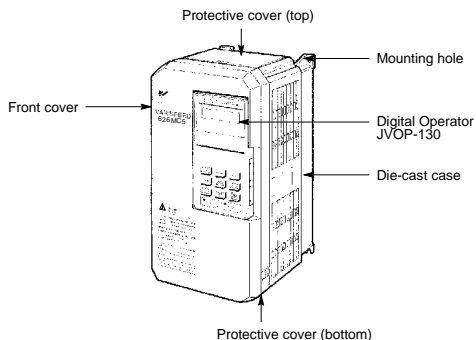

Fig 1.2 Appearance of VS-626MC5, Model CIMR-MC5A20P4 (200 V, 0.4 kW)

A 200 V Class Inverter with 0.4 kW Output is shown below with the front cover removed.

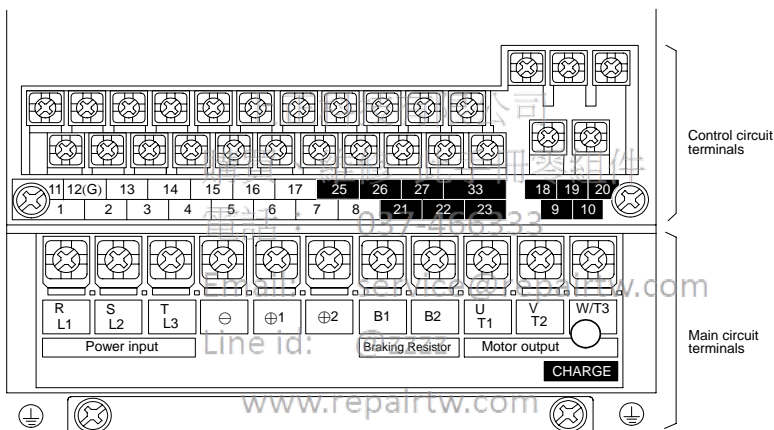

Fig 1.3 Terminal Arrangement

1.2.2 Digital Operator Components

This section describes the component names and functions of the Digital Operator. The component names and functions are shown in *Figure 1.4* and key functions are described in *Table 1.4*.

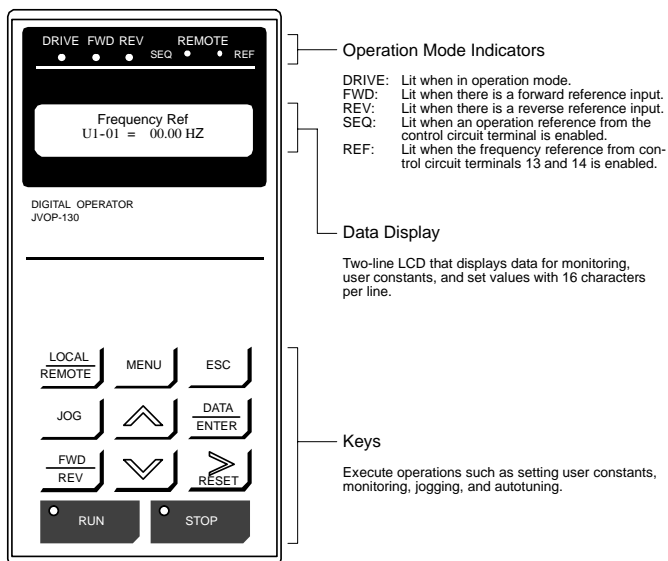

Fig 1.4 Digital Operator Component Names and Functions

購買、維修 此手冊零組件











電話： 037-466333

Email: service@repairtw.com

Line id: @zzzz

www.repairtw.com

Table 1.4 Key Functions

Key	Name	Function
	LOCAL/REMOTE Key	Switches between (LOCAL) operation via the Digital Operator and control circuit terminal (REMOTE) operation. This key can be enabled or disabled by setting a user constant (o2-01).
	MENU Key	Displays menus.
	ESC Key	Returns to the status before the DATA/ENTER Key was pressed.
	JOG Key	Enables jog operation when the VS-626MC5 is being operated from the Digital Operator.
	FWD/REV Key	Selects the rotation direction of the motor when the VS-626MC5 is being operated from the Digital Operator.
	RESET Key	Sets the number of digits for user constant settings. Also acts as the reset key when a fault has occurred.
	Increment Key	Selects menu items, groups, functions, and user constant names, and increments set values.
	Decrement Key	Selects menu items, groups, functions, and user constant names, and decrements set values.
	DATA/ENTER Key	Enters menu items, functions, constants, and set values after they are set.
	RUN Key	Starts the VS-626MC5 operation when the VS-626MC5 is in operation with the Digital Operator.
	STOP Key	Stops VS-626MC5 operation. This key can be enabled or disabled by setting a user constant (o2-02) when operating from the control circuit terminal.

Note Except in diagrams, keys are referred to using the key names listed in the above table.

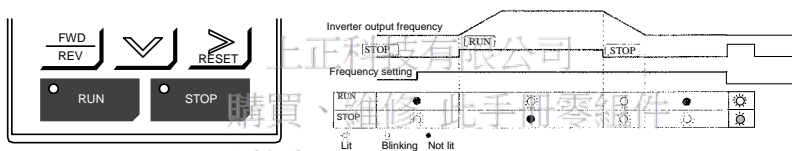

The RUN and STOP indicators light and blink to indicate operating status.

Fig 1.5 RUN and STOP Indicators

Email: service@repairtw.com

Line id: @zzzz

www.repairtw.com

2

Handling Inverters

2

This chapter describes the checks required upon receiving a VS-626MC5 Inverter and describes installation methods.

2.1 Confirmations upon Delivery	2-2
2.1.1 Nameplate Information	2-2
2.2 Exterior and Mounting Dimensions	2-4
2.3 Checking and Controlling the Installation	
Site	2-6
2.3.1 Installation Site	2-6
2.3.2 Controlling the Ambient Temperature	2-6
2.3.3 Protecting the Inverter from Foreign Matter	2-6
2.4 Installation Orientation and Space	2-7
2.5 Removing/Attaching the Digital Operator and	
Front Cover	2-8
2.5.1 Inverters of 15 kW or Less	2-8
2.5.2 Inverters of 18.5 kW or Higher	2-9

購買 維修 此 手冊 零組件
電話： 037-466333

Email: service@repairtw.com

Line id: @zzzz

www.repairtw.com

2.1 Confirmations upon Delivery

 CAUTION
<ul style="list-style-type: none"> Never install an Inverter that is damaged or missing components. Doing so can result in injury.

Check the following items as soon as the Inverter is delivered.

Table 2.1 Checks

Item	Method
Has the correct model of Inverter been delivered?	Check the model number on the nameplate on the side of the Inverter (See 2.1.1).
Is the Inverter damaged in any way?	Inspect the entire exterior of the Inverter to see if there are any scratches or other damage resulting from shipping.
Are any screws or other components loose?	Use a screwdriver or other tools to check for tightness.

If you find any irregularities in the above items, contact the agency from which you purchased the Inverter or your Yaskawa representative immediately.

2.1.1 Nameplate Information

Example Nameplate

Standard domestic (Japan) Inverter: 3-phase, 200 VAC, 0.4 kW, IEC IP20 and NEMA 1 standards

Model number →	MODEL : CIMR-MC5A20P4 SPEC: 20P41F	← Inverter specifications
Input specifications →	INPUT : AC 3PH 200-220 V 50Hz 200-230 V 60Hz	
Output specifications →	OUTPUT: AC 3PH 0-230 V 1.2kVA 3.2 A	
Lot number →	LOT NO :	← Mass
Serial number →	SER NO :	
	YASKAWA ELECTRIC CORPORATION JAPAN	

Inverter Model Numbers

VS-626MC5

Inverter

CIMR MC5 A 2 0P4

No.	Specification
A	Standard domestic model

No.	Specification
2	AC input, 3-phase, 200 V
4	AC input, 3-phase, 400 V

No.	Max. Motor Capacity
0P4	0.4 kW
0P7	0.75 kW
to 075	to 75 kW

P indicates the decimal point.

■ Inverter Specifications

No.	Voltage Class
2	AC input, 3-phase, 200 V
4	AC input, 3-phase, 400 V

No.	Max. Motor Capacity
0P4	0.4 kW
0P7 to 075	0.75 kW to 75 kW

No.	Protective Structure
0	Open chassis (IEC IP00)
1	Enclosed wall-mounted (IEC IP20, NEMA 1)

2 0P4 1 E

Version (Enter the specifications form number when special specifications are required.)

*"P" indicates the decimal point.

- Open Chassis Type (IEC IP00)
Protected so that parts of the human body cannot reach electrically charged parts from the front when the Inverter is mounted in a control panel.
- Enclosed Wall-mounted Type (IEC IP20, NEMA 1)
The Inverter is structured so that the Inverter is shielded from the exterior, and can thus be mounted to the interior wall of a standard building (not necessarily enclosed in a control panel). The protective structure conforms to the standards of NEMA 1 in the USA.

上正科技有限公司

購買、維修 此手冊零組件

電話： 037-466333

Email: service@repairtw.com

Line id: @zzzz

www.repairtw.com

2.2 Exterior and Mounting Dimensions

■ 200 V/400 V Class Inverters of 15 kW and Lower

The following diagram shows a 200 V class, 1.5 kW Inverter.

Remove the top and bottom covers when mounting 200 V/400 V class Inverters of 15 kW or lower in a control panel.

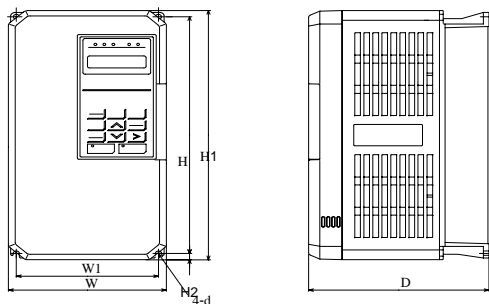

■ 200 V/400 V Class Inverters of 18.5 kW and Higher

The following diagram shows a 200 V class, 18.5 kW Inverter.

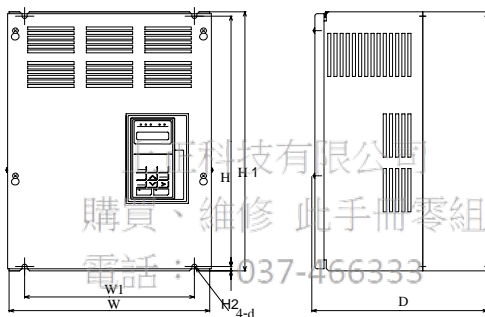

Email: service@repairtw.com

Line id: @zzzz

www.repairtw.com

Table 2.2 VS-626MC5 External Dimensions (mm) and Approx. Masses (kg)

Voltage class	Max. Applicable Motor Output [kW]	Open Chassis (IP00)							Enclosed Wall-mounted (NEMA1)							DC Reactor	
		W	H	D	W1	H1	H2	Approx. Mass	W	H	D	W1	H1	H2	Approx. Mass		Mounting Holes d*1
200 V class	0.4																Option
	0.75	140	280	160	126	266	7.0	3	140	280	160	126	266	7.0	3	M5	
	1.5																
	2.2	140	280	180	126	266	7.0	4.5	140	280	180	126	266	7.0	4.5	M5	
	3.7																
	5.5	200	300	205	186	285	8.0	5.5							5.5	M6	
	7.5							6	200	300	205	186	285	8.0	6		
	11	250	380	225	236	365	7.5	11	250	380	225	236	365	7.5	11	M6	
	15									400				27.5			
	18.5	325	450	285	275	435	7.5	28	330	610	285	275	435	87.5	32	M6	
	22									675				152.5			
	30	425	675	350	320	650	12.5	61	430	985	350	320	650	212.5	67	M10	
	37							62							68		
	45	475	800	350	370	775	12.5	80	480	1110	350	370	775	212.5	87	M10	
55																	
75	575	925	400	445	895	15.0	135	580	1290	400	445	895	270	145	M12		
400 V class	0.4																Option
	0.75	140	280	160	126	266	7.0	3	140	280	160	126	266	7.0	3	M5	
	1.5							4							4		
	2.2	140	280	180	126	266	7.0	4.5	140	280	180	126	266	7.0	4.5	M5	
	3.7																
	5.5	200	300	205	186	285	8.0	6	200	300	205	186	285	8.0	6	M6	
	7.5																
	11	250	380	225	236	365	7.5	11	250	380	225	236	365	7.5	11	M6	
	15																
	18.5	325	450	285	275	435	7.5	29	330	610	285	275	435	87.5	32	M6	
	22							31							34		
	30	425	675	350	320	650	12.5	61	430	985	350	320	650	212.5	67	M10	
	37	325	625	285	275	610	7.5	44	330	785	285	275	610	87.5	48	M6	
	45									850				152.5			
55	455	820	350	350	795	12.5	81	460	1130	350	350	795	212.5	87	M10		
75							82							88			

* 1. Same for open chassis and enclosed wall-mounted types.

* 2. See page - 4 for mounting dimensions.

Note An attachment is required to mount the cooling fins (in section) on the outside of the control panel for 200 V/400 V class Inverters of 15 kW or less. Please ask your Yaskawa representative for details. Dimensional drawings for models with externally mounted cooling fins and other special requirements are also available from your Yaskawa representative.

www.repairtw.com

2.3 Checking and Controlling the Installation Site



CAUTION

- Always hold the case when carrying the Inverter.
If the Inverter is held by the front cover, the main body of the Inverter may fall, possibly resulting in injury.
- Attach the Inverter to a metal or other noncombustible material.
Fire can result if the Inverter is attached to a combustible material.
- Install a cooling fan or other cooling device when installing more than one Inverter in the same enclosure so that the temperature of the air entering the Inverters is below 45°C.
Overheating can result in fires or other accidents.

Install the VS-626MC5 in the installation site described below and maintain optimum conditions.

2.3.1 Installation Site

Install the Inverter under the following conditions.

Type	Ambient Operating Temperature	Humidity
Enclosed wall-mounted	-10 to 40°C	90% RH or less (no condensation)
Open chassis	-10 to 45°C	90% RH or less (no condensation)

Protection covers are attached to the top and bottom of the Inverter. Be sure to remove the protection covers before installing a 200 or 400 V Class Inverter with an output of 15 kW or less in a panel.

- Install the Inverter in a clean location free from oil mist and dust. It can be installed in a totally enclosed panel that is completely shielded from floating dust.
- When installing or operating the Inverter, always take special care so that metal powder, oil, water, or other foreign matter does not get into the Inverter.
- Do not install the Inverter on combustible material, such as wood.
- Install the Inverter in a location free from radioactive materials and combustible materials.
- Install the Inverter in a location free from harmful gasses and liquids.
- Install the Inverter in a location without excessive oscillation.
- Install the Inverter in a location free from chlorides.
- Install the Inverter in a location not in direct sunlight.

2.3.2 Controlling the Ambient Temperature

To enhance the reliability of operation, the Inverter should be installed in an environment free from extreme temperature increases. If the Inverter is installed in an enclosed environment, such as a box, use a cooling fan or air conditioner to maintain the internal air temperature below 45°C.

2.3.3 Protecting the Inverter from Foreign Matter

Place a cover over the Inverter during installation to shield it from metal power produced by drilling.

Always remove the cover from the Inverter after completing installation. Otherwise, ventilation will be reduced, causing the Inverter to overheat.

Line id: @zzzz

www.repairtw.com

2.4 Installation Orientation and Space

Install the Inverter on a vertical surface so as not to reduce the cooling effect. When installing the Inverter, always provide the following installation space to allow normal heat dissipation.

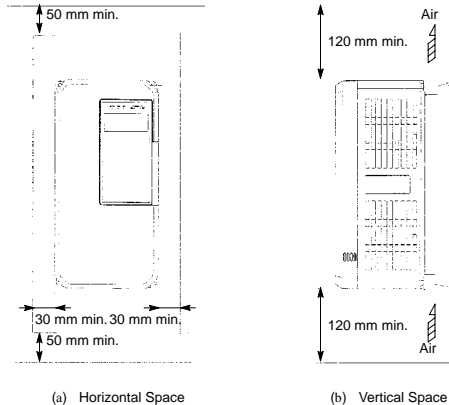

Fig 2.1 VS-626MC5 Installation Orientation and Space

IMPORTANT

- The same space is required horizontally and vertically for both open chassis (IP00) and enclosed wall-mounted (IP20, NEMA 1) Inverters.
- Always remove the protection covers before installing a 200 or 400 V Class Inverter with an output of 15 kW or less in a panel.
- Always provide enough space for suspension eye bolts and the main circuit lines when installing a 200 or 400 V Class Inverter with an output of 30 kW or more in a panel.

購買、維修 此手冊零組件

電話： 037-466333

Email: service@repairtw.com

Line id: @zzzz

www.repairtw.com

2.5 Removing/Attaching the Digital Operator and Front Cover

Remove the front cover to wire the terminals.

For models of 15 kW or less (both 200 V and 400 V class), do not remove or mount the front cover without first removing the Digital Operator; otherwise, the Digital Operator may malfunction due to imperfect contact. Use the following procedures to remove or attach the front cover.

2.5.1 Inverters of 15 kW or Less

■ Removing the Digital Operator

Press the lever on the side of the Digital Operator in the direction of arrow 1 to unlock the Digital Operator and lift the Digital Operator in the direction of arrow 2 to remove the Digital Operator as shown in the following illustration.

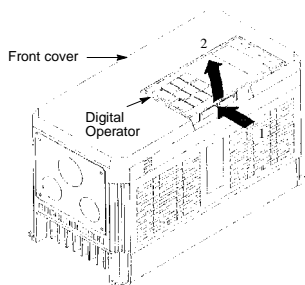

Fig 2.2 Removing the Digital Operator

■ Removing the Front Cover

Press the left and right sides of the front cover in the directions of arrows 1 and lift the bottom of the cover in the direction of arrow 2 to remove the front cover as shown in the following illustration.

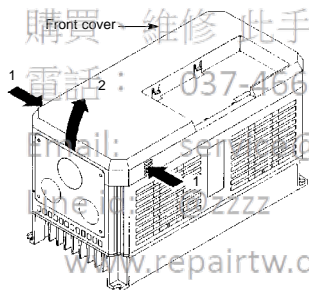

Fig 2.3 Removing the Front Cover

■ Mounting the Front Cover

After wiring the terminals, mount the front cover to the Inverter by performing in reverse order to the steps to remove the front cover.

1. Do not mount the front cover with the Digital Operator attached to the front cover; otherwise, Digital Operator may malfunction due to imperfect contact.
2. Insert the tab of the upper part of the front cover into the groove of the Inverter and press the lower part of the front cover onto the Inverter until the front cover snaps shut.

■ Mounting the Digital Operator

1. Hook the Digital Operator at A (two locations) on the front cover in the direction of arrow 1 as shown in the following illustration.
2. Press the Digital Operator in the direction of arrow 2 until it snaps in place at B (two locations).

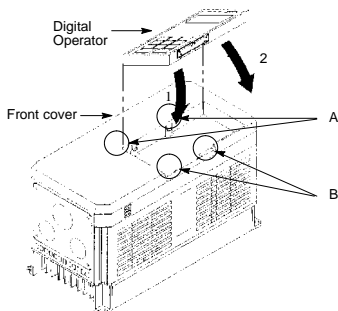

Fig 2.4 Mounting the Digital Operator

NOTE

1. Do not remove or attach the Digital Operator or mount or remove the front cover using methods other than those described above, otherwise the Inverter may break or malfunction due to imperfect contact.
2. Never attach the front cover to the Inverter with the Digital Operator attached to the front cover. Imperfect contact can result.
Always attach the front cover to the Inverter by itself first, and then attach the Digital Operator to the front cover.

電話：037-466333

2.5.2 Inverters of 18.5 kW or Higher

The front cover can be removed without removing the Digital Operator from the Inverter provided that the Inverter has an output of 18.5 kW or higher.

Loosen the four screws of the front cover and move the front cover slightly upwards to remove the front cover.

www.repairtw.com

3

Wiring

3

This chapter describes wiring terminals, main circuit terminal connections, main circuit terminal wiring specifications, control circuit terminals, and control circuit wiring specifications.

3.1	Connections to Peripheral Devices	3 - 3
3.2	Connection Diagram	3 - 4
3.3	Terminal Block Configuration	3 - 5
3.4	Wiring Main Circuit Terminals	3 - 6
3.4.1	Applicable Wire Sizes and Closed Loop Connectors	3 - 6
3.4.2	Main Circuit Terminal Functions	3 - 9
3.4.3	Main Circuit Configurations	3 - 10
3.4.4	Standard Connection Diagrams	3 - 12
3.4.5	Wiring the Main Circuits	3 - 13
3.5	Wiring Control Circuit Terminals	3 - 20
3.5.1	Wire Sizes and Closed-loop Connectors	3 - 20
3.5.2	Control Circuit Terminal Functions	3 - 21
3.5.3	Control Circuit Terminal Connections (All Models)	3 - 22
3.5.4	Control Circuit Wiring Precautions	3 - 23
3.6	Wiring Check	3 - 23
3.7	Installing and Wiring PG Speed Control Cards	3 - 24
3.7.1	Installing a PG Speed Control Card	3 - 24
3.7.2	PG Speed Control Card Terminal Blocks	3 - 25
3.7.3	Wiring a PG Speed Control Card	3 - 26
3.7.4	Wiring PG Speed Control Card Terminal Blocks	3 - 28
3.7.5	Selecting the Number of PG (Encoder) Pulses	3 - 30

**WARNING**

- Always turn OFF the input power supply before wiring terminals.
Otherwise, an electric shock or fire can occur.
- Wiring must be performed by an authorized person qualified in electrical work.
Otherwise, an electric shock or fire can occur.
- Be sure to ground the ground terminal.
(200 V class: Ground to 100 Ω or less, 400 V class: Ground to 10 Ω or less)
Otherwise, an electric shock or fire can occur.
- Always check the operation of any emergency stop circuits after they are wired.
Otherwise, there is the possibility of injury. (Wiring is the responsibility of the user.)
- Never touch the output terminals directly with your hands or allow the output lines to come into contact with the Inverter case. Never short the output circuits.
Otherwise, electrical shock or grounding can occur.

**CAUTION**

- Check to be sure that the voltage of the main AC power supply satisfies the rated voltage of the Inverter.
Injury or fire can occur if the voltage is not correct.
- Do not perform voltage withstand tests on the Inverter.
Otherwise, semiconductor elements and other devices can be damaged.
- Connect braking resistors, Braking Resistor Units, and Braking Units as shown in the I/O wiring examples.
Otherwise, a fire can occur.
- Tighten all terminal screws to the specified tightening torque.
Otherwise, a fire may occur.
- Do not connect AC power to output terminals U, V, and W.
The interior parts of the Inverter will be damaged if voltage is applied to the output terminals.
- Do not connect phase-advancing capacitors or LC/RC noise filters to the output circuits.
The Inverter can be damaged or internal parts burnt if these devices are connected.
- Do not connect electromagnetic switches or contactors to the output circuits.
If a load is connected while the Inverter is operating, surge current will cause the overcurrent protection circuit inside the Inverter to operate.

購買、維修 此手冊零組件

電話： 037-466333

Email: service@repairtw.com

Line id: @zzzz

www.repairtw.com

3.1 Connections to Peripheral Devices

Examples of connections between the VS-626MC5 and typical peripheral devices are shown in *Figure 3.1*. Use this illustration to gain an understanding of the overall equipment configuration.

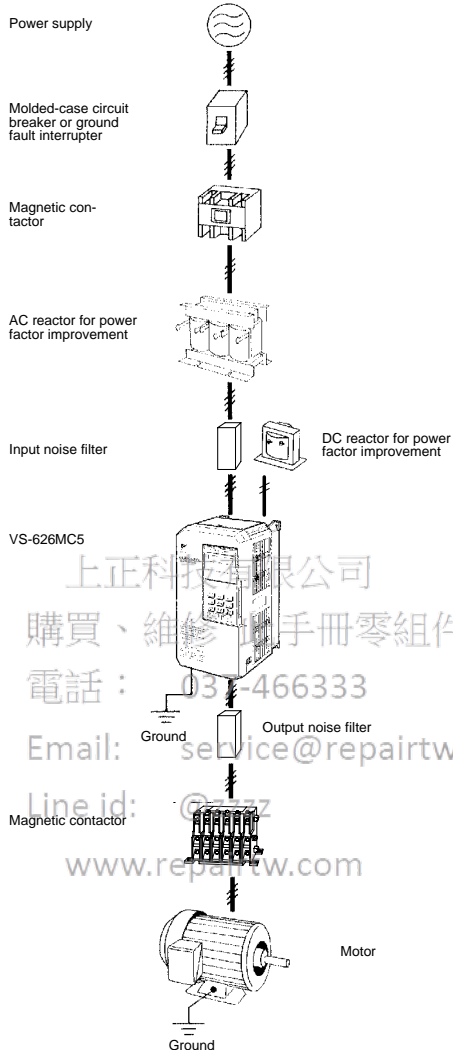

Fig 3.1 Example Connections to Peripheral Devices

3.2 Connection Diagram

The connection diagram of the VS-626MC5 is shown in Figure 3.2.

When using the Digital Operator, the motor can be operated by wiring only the main circuits.

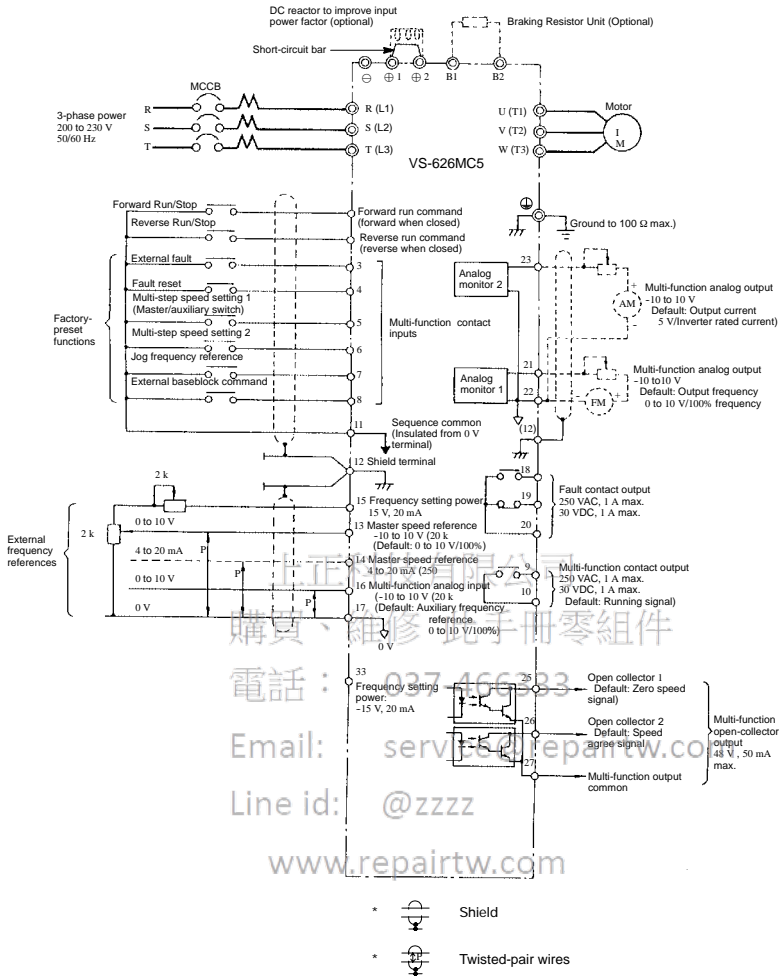

Fig 3.2 Connection Diagram (Model CIMR-MC5A27P5 Shown Above)

NOTE

- Control circuit terminals 1 to 33 are not arranged in order of terminal numbers; they are arranged as shown below. Be sure to wire them correctly.

11	12(G)	13	14	15	16	17	25	26	27	33	18	19	20
1	2	3	4	5	6	7	8	21	22	23	9	10	

- Do not use control circuit terminals 13 and 14 at the same time.
(The two signals will be added inside the Inverter if they are input at the same time.)
- The maximum output current capacity of the +15 V/-15 V output from control circuit terminals 15 and 33 is 20 mA.
- The multi-function analog output is a dedicated meter output for a frequency meter, ammeter, etc. Do not use this output for feedback control or for any other control purpose.
Use one of the optional Analog Monitor Cards (AO-08 or AO-012) for analog outputs to the control system.
- Disable the stall prevention during deceleration (set constant L3-04 to 0) when using a Braking Resistor Unit. If this user constant is not changed to disable stall prevention, the system may not stop during deceleration.
- Set constant L8-01 to 1, 2 or 3 to enable protection for the internal DB resistor (model ERF) when using an internal braking resistor. The braking resistor will not be protected unless this setting is changed to enable protection.
- DC reactors to improve the input power factor can be connected as an option only to Inverters for 15 kW or less. Remove the short bar from between $\oplus 1$ and $\oplus 2$ when connecting a DC reactor.
- There is no DC power supply input terminals for 200 V class Inverters of 30 to 75 kW and 400 V class Inverters of 55 to 75 kW, and DC power cannot be input to these Inverters.

3.3 Terminal Block Configuration

The terminal block for a 200 V class Inverter with an output of 0.4 kW is shown in *Figure 3.3*.

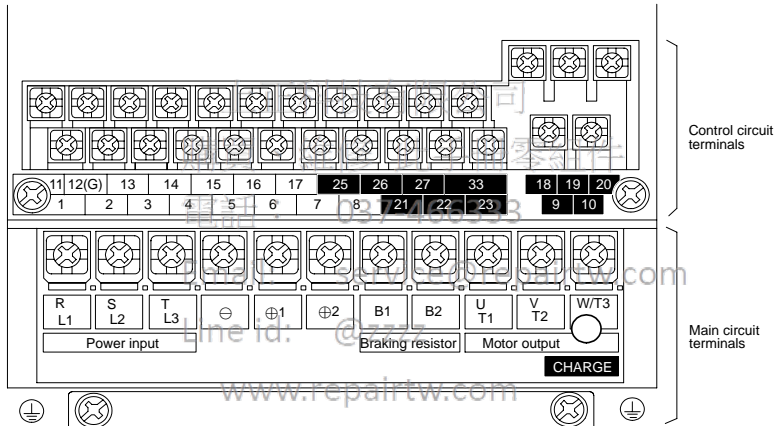

Fig 3.3 Terminal Arrangement

3.4 Wiring Main Circuit Terminals

3.4.1 Applicable Wire Sizes and Closed-loop Connectors

Select the appropriate wires and crimp terminals from *Table 3.1* to *Table 3.3*. Refer to instruction manual TOE-C726-2□ for wire sizes for Braking Resistor Units and Braking Units.

Table 3.1 200 V Class Wire Sizes

Circuit	VS-626MC5 Model CIMR□□□□	Terminal Symbol	Terminal Screws	Wire Thickness (see note) mm ²	Wire Type
Main Circuits	MC5A20P4	R, S, T, ⊕, ⊕ 1, ⊕ 2, B1, B2, U, V, W	M4	2 to 5.5	Power cables, e.g., 600 V vinyl power cables
		⊕			
	MC5A20P7	R, S, T, ⊕, ⊕ 1, ⊕ 2, B1, B2, U, V, W	M4	2 to 5.5	
		⊕			
	MC5A21P5	R, S, T, ⊕, ⊕ 1, ⊕ 2, B1, B2, U, V, W	M4	2 to 5.5	
		⊕		3.5 to 5.5	
	MC5A22P2	R, S, T, ⊕, ⊕ 1, ⊕ 2, B1, B2, U, V, W	M4	3.5 to 5.5	
		⊕			
	MC5A23P7	R, S, T, ⊕, ⊕ 1, ⊕ 2, B1, B2, U, V, W	M4	5.5	
		⊕			
	MC5A25P5	R, S, T, ⊕, ⊕ 1, ⊕ 2, B1, B2, U, V, W	M5	8	
		⊕		5.5 to 8	
	MC5A27P5	R, S, T, ⊕, ⊕ 1, ⊕ 2, B1, B2, U, V, W	M5	8	
		⊕		5.5 to 8	
	MC5A2011	R, S, T, ⊕, ⊕ 1, ⊕ 2, ⊕ 3, U, V, W	M6	22	
		⊕		8	
	MC5A2015	R, S, T, ⊕, ⊕ 1, ⊕ 2, ⊕ 3, U, V, W	M8	30	
		⊕	M6	8	
	MC5A2018	R, S, T, ⊕, ⊕ 1, ⊕ 2, ⊕ 3, U, V, W	M8	30	
		⊕		14	
MC5A2022	R, S, T, ⊕, ⊕ 1, ⊕ 2, ⊕ 3, U, V, W	M8	38		
	⊕		14		
MC5A2030	R, S, T, U, V, W	M10	38 to 100		
	⊕, ⊕ 3	M8	22		
	⊕	M8	22		
	R, Δ	M4	0.5 to 5.5		
MC5A2037	R, S, T, U, V, W	M10	38 to 100		
	⊕, ⊕ 3	M8	22		
	⊕	M8	22		
	R, Δ	M4	0.5 to 5.5		
MC5A2045	R, S, T, U, V, W	M10	60 to 100		
	⊕, ⊕ 3	M8	22		
	⊕	M8	22		
	R, Δ	M4	0.5 to 5.5		
MC5A2055	R, S, T, U, V, W	M10	100		
	⊕, ⊕ 3	M8	22		
	⊕	M8	30		
	R, Δ	M4	0.5 to 5.5		
MC5A2075	R, S, T, U, V, W	M12	100 to 200		
	⊕, ⊕ 3	M8	22		
	⊕	M8	30		
	R, Δ	M4	0.5 to 5.5		
Control Circuits	All models	1 to 33	M3.5	0.5 to 2	Shielded twisted-pair wires

Note The wire thickness is set for copper wires at 75°C.

Table 3.2 400 V Class Wire Sizes

Circuit	VS-626MC5 Model CIMR□	Terminal Symbol	Terminal Screws	Wire Thickness (see note) mm ²	Wire Type
Main Circuits	MC5A40P4	R, S, T, ⊖, ⊕ 1, ⊕ 2, B1, B2, U, V, W Ⓢ	M4	2 to 5.5	Power cables, e.g., 600 V vinyl power cables
	MC5A40P7	R, S, T, ⊖, ⊕ 1, ⊕ 2, B1, B2, U, V, W Ⓢ	M4	2 to 5.5	
	MC5A41P5	R, S, T, ⊖, ⊕ 1, ⊕ 2, B1, B2, U, V, W Ⓢ	M4	2 to 5.5	
	MC5A42P2	R, S, T, ⊖, ⊕ 1, ⊕ 2, B1, B2, U, V, W Ⓢ	M4	2 to 5.5	
	MC5A43P7	R, S, T, ⊖, ⊕ 1, ⊕ 2, B1, B2, U, V, W Ⓢ	M4	2 to 5.5	
				3.5 to 5.5	
	MC5A45P5	R, S, T, ⊖, ⊕ 1, ⊕ 2, B1, B2, U, V, W Ⓢ	M4	3.5 to 5.5	
	MC5A47P5	R, S, T, ⊖, ⊕ 1, ⊕ 2, B1, B2, U, V, W Ⓢ	M5	5.5	
	MC5A4011	R, S, T, ⊖, ⊕ 1, ⊕ 2, B1, B2, U, V, W Ⓢ	M5	8 to 14	
				M6	
	MC5A4015	R, S, T, ⊖, ⊕ 1, ⊕ 2, B1, B2, U, V, W Ⓢ	M5	8 to 14	
				M6	
	MC5A4018	R, S, T, ⊖, ⊕ 1, ⊕ 2, ⊕ 3, U, V, W Ⓢ	M6	14	
				M8	
	MC5A4022	R, S, T, ⊖, ⊕ 1, ⊕ 2, ⊕ 3, U, V, W Ⓢ	M4	0.5 to 5.5	
				M6	
	MC5A4030	R, S, T, ⊖, ⊕ 1, ⊕ 2, ⊕ 3, U, V, W Ⓢ	M8	8	
				M4	
	MC5A4037	R, S, T, ⊖, ⊕ 1, ⊕ 2, ⊕ 3, U, V, W Ⓢ	M8	30	
				M4	
	MC5A4045	R, S, T, ⊖, ⊕ 1, ⊕ 2, ⊕ 3, U, V, W Ⓢ	M8	50	
				M4	
	MC5A4055	R, S, T, U, V, W Ⓢ, ⊕ 3	M10	38 to 100	
				M8	
MC5A4075	R, S, T, U, V, W Ⓢ, ⊕ 3	M10	0.5 to 5.5		
			M8	38 to 100	
			M8	22	
			M4	0.5 to 5.5	
Control Circuits	All models	1 to 33	M3.5	0.5 to 2	Shielded twisted-pair wires

Note The wire thickness is set for copper wires at 75 °C.

Email: service@repairtw.com

Line id: @zzzz

www.repairtw.com

Table 3.3 Closed-loop Connector Sizes (JIS C 2805) (For 200 V/400 V Classes)

Wire Thickness mm ²	Terminal Screws	Size
0.5	M3.5	1.25 to 3.5
	M4	1.25 to 4
0.75	M3.5	1.25 to 3.5
	M4	1.25 to 4
1.25	M3.5	1.25 to 3.5
	M4	1.25 to 4
2	M3.5	2 to 3.5
	M4	2 to 4
	M5	2 to 5
	M6	2 to 6
3.5/5.5	M4	5.5 to 4
	M5	5.5 to 5
	M6	5.5 to 6
	M8	5.5 to 8
8	M5	8 to 5
	M6	8 to 6
	M8	8 to 8
14	M6	14 to 6
	M8	14 to 8
22	M6	22 to 6
	M8	22 to 8
30/38	M8	38 to 8
50/60	M8	60 to 8
	M10	60 to 10
80	M10	80 to 10
100		100 to 10
100		100 to 12
150	M12	150 to 12
200		200 to 12

NOTE

Determine the wire size for the main circuit so that line voltage drop is within 2% of the rated voltage.

Line voltage drop is calculated as follows:

(If there is the possibility of excessive voltage drop, use a larger wire suitable to the required length.)

Line voltage drop (V) = $\sqrt{3}$ x wire resistance (Ω /km) x wire length (m) x current (A) x 10^{-3}

Line id: @zzzz

www.repairtw.com

3.4.2 Main Circuit Terminal Functions

Main circuit terminal functions are summarized according to terminal symbols in *Table 3.4* and *Table 3.5*. Wire the terminals correctly for the desired purposes.

Table 3.4 200 V Class Main Circuit Terminal Functions

Purpose	Terminal Symbol	Model: CIMR-MC5A
Main circuit power input	R (L1), S (L2), T (L3)	20P4 to 2075
Inverter outputs	U (T1), V (T2), W (T3)	20P4 to 2075 (all models)
DC power input	$\oplus 1 - \ominus$	20P4 to 2022
Braking Resistor Unit connection	B1, B2	20P4 to 27P5
DC reactor connection	$\oplus 1 - \oplus 2$	20P4 to 2015
Braking Unit connection	$\oplus 3 - \ominus$	2011 to 2075
Cooling fan power input	r, Δ	2018 to 2022
Cooling fan power input (control power input)	r, Δ	2030 to 2075
Ground	$\opl�$	20P4 to 2075 (all models)

Note: Models CIMR-MC5A2030 to 2075 do not support standard DC power input.

Table 3.5 400 V Class Main Circuit Terminal Functions

Purpose	Terminal Symbol	Model: CIMR-MC5A
Main circuit power input	R (L1), S (L2), T (L3)	40P4 to 4075
Inverter outputs	U (T1), V (T2), W (T3)	40P4 to 4075 (all models)
DC power input	$\oplus 1 - \ominus$	40P4 to 4045
Braking Resistor Unit connection	B1, B2	40P4 to 4015
DC reactor connection	$\oplus 1 - \oplus 2$	40P4 to 4015
Braking Unit connection	$\oplus 3 - \ominus$	4018 to 4075
Cooling fan power input	r, Δ	4018 to 4045
Cooling fan power input (control power input)	r - Δ 200: 200 to 230 VAC input r - Δ 400: 380 to 460 VAC input	4055 to 4075
Ground	$\opl�$	40P4 to 4075 (all models)

Note: Models CIMR-MC5A4055 to 4075 do not support standard DC power input.

購買、維修 此手冊零組件

電話： 037-466333

Email: service@repairtw.com

Line id: @zzzz

www.repairtw.com

3.4.3 Main Circuit Configurations

The main circuit configurations are shown in *Figure 3.4* and *Figure 3.5*.

■ 200 V Class

CIMR-MC5A20P4 to 21P5 (0.4 to 1.5 kW)

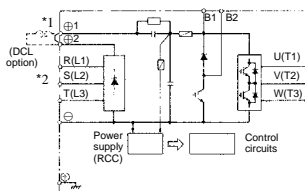

CIMR-MC5A22P2 to 27P5 (2.2 to 7.5 kW)

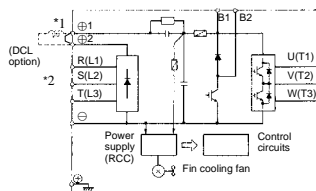

CIMR-MC5A2011 to 2015 (11, 15 kW)

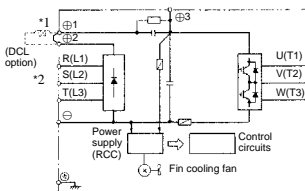

CIMR-MC5A2018 to 2022 (18.5, 22 kW)

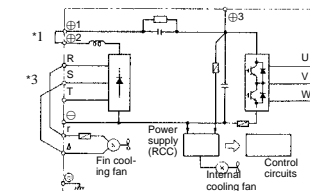

CIMR-MC5A2030 to 2075 (30 to 75 kW)

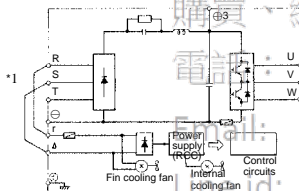

* 1 Prewired at the factory.

* 2 Remove the short-circuit bar from between ① and ② when connecting a DC reactor to Inverters of 15 kW or less.

* 3 Prewired at the factory. When supplying power to the main circuits from the DC power supply, remove the wiring from R-r and S-Δ.

Fig 3.4 200 V Class Inverter Main Circuit Configurations

上正科技有限公司

購買 維修 此手冊零組件

電話: 037-466333

service@repairtw.com

@zzzz

www.repairtw.com

■ 400 V Class

CIMR-MC5A40P4 to 41P5 0.4 to 1.5 kW

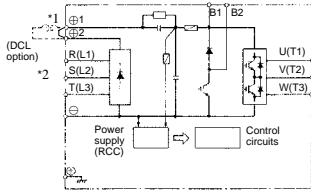

CIMR-MC5A42P2 to 43P7 2.2 3.7 kW

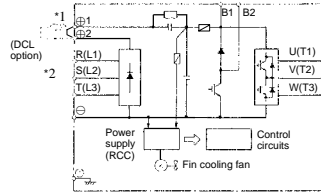

CIMR-MC5A45P5 to 4015 5.5 to 15 kW

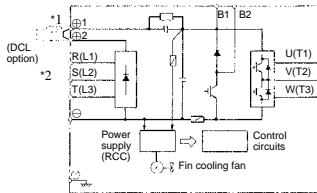

CIMR-MC5A4018 to 4045 18.5 to 45 kW

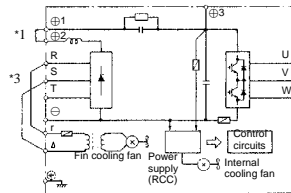

CIMR-MC5A4055 to 4075 55 75 kW

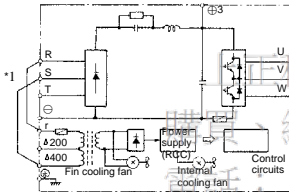

- * 1 Prewired at the factory.
- * 2 Remove the short-circuit bar from between ϕ1 and ϕ2 when connecting a DC reactor to Inverters of 15 kW or less.
- * 3 Prewired at the factory. When supplying power to the main circuits from the DC power supply, remove the wiring from R-r and S-s.

Fig 3.5 400 V Class Inverter Main Circuit Configurations

www.repairtw.com

3.4.4 Standard Connection Diagrams

CIMR-MC5A20P4 to 27P5, 40P4 to 4015

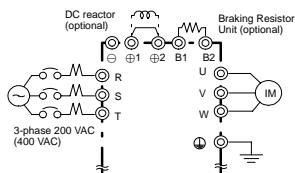

Be sure to remove the short-circuit bar before connecting a DC reactor.

CIMR-MC5A2011, 2015

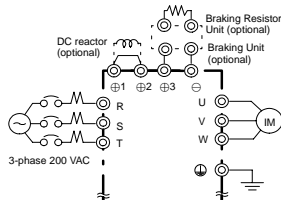

Be sure to remove the short-circuit bar before connecting a DC reactor.

CIMR-MC5A2018, 2022, 4018 to 4045

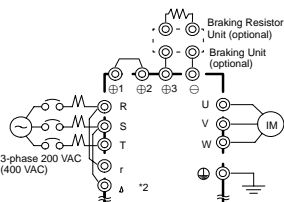

The DC reactor is built in.

CIMR-MC5A2030 to 2075

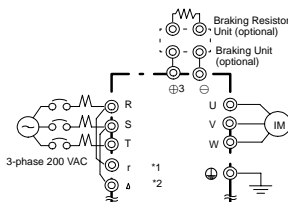

The DC reactor is built in.

CIMR-MC5A4055 to 4075

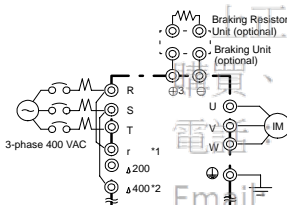

The DC reactor is built in.

- * 1 Input the control circuit power supply from r- Δ for 200 V class Inverters of 30 to 75 kW (2030 to 2075) and from r- Δ 400 for 400 V class Inverters of 55 to 75 kW (4055 to 4075). (For other models, the control power supply is supplied internally from the main circuit DC power supply.)

- * 2 The r-R, Δ (400)-S terminals are short-circuited for shipping. Remove the short wiring from the 2018, 2022, 4018 to 4045 when supplying power to the main circuits from the DC power supply.

Fig 3.6 Main Circuit Terminal Connections

3.4.5 Wiring the Main Circuits

This section describes wiring connections for the main circuit inputs and outputs.

■ Wiring Main Circuit Inputs

Installing a Molded-case Circuit Breaker

Always connect the power input terminals (R, S, and T) and power supply via a molded-case circuit breaker (MCCB) suitable for the Inverter.

- Choose an MCCB with a capacity of 1.5 to 2 times the Inverter's rated current.
- For the MCCB's time characteristics, be sure to consider the Inverter's overload protection (one minute at 150% of the rated output current).
- If the same MCCB is to be used for more than one Inverter, or other devices, set up a sequence so that the power supply will be turned OFF by a fault output, as shown in *Figure 3.7*.

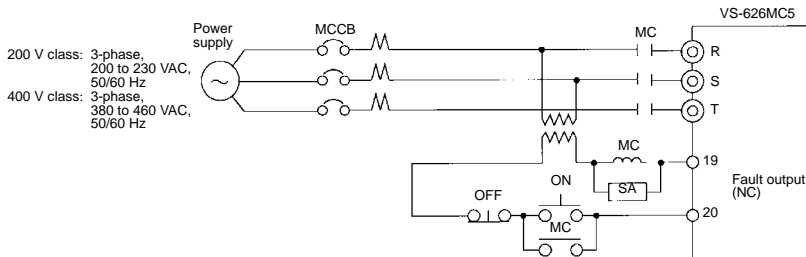

* For 400 V class Inverters, connect a 400/200 V transformer.

Fig 3.7 MCCB Installation

Installing a Ground Fault Interrupter

Inverter outputs use high-speed switching, so high-frequency leakage current is generated. Therefore, at the Inverter primary side, use a ground fault interrupter that detects only the leakage current in the frequency range that is hazardous to humans and excludes high-frequency leakage current.

- For the special-purpose ground fault interrupter for inverters, choose a ground fault interrupter with a sensitivity amperage of at least 30 mA per Inverter.
- When using a general ground fault interrupter, choose a ground fault interrupter with a sensitivity amperage of 200 mA or more per Inverter and with an operating time of 0.1 s or more.

Installing a Magnetic Contactor

If the power supply for the main circuit is to be shut off during a sequence, a magnetic contactor can be used instead of a molded-case circuit breaker.

When a magnetic contactor is installed on the primary side of the main circuit to forcibly stop the Inverter, however, the regenerative braking does not work and the Inverter will coast to a stop.

- The Inverter can be started and stopped by opening and closing the magnetic contactor on the primary side. Frequently opening and closing the magnetic contactor, however, may cause the Inverter to break down.
- When the Inverter is operated with the Digital Operator, automatic operation cannot be performed after recovery from a power interruption.
- If the Braking Resistor Unit is used, program the sequence so that the magnetic contactor is turned OFF by the contact of the Unit's thermal overload relay.

Connecting Input Power Supply to the Terminal Block

Input power supply can be connected to any terminal R, S or T on the terminal block; the phase sequence of input power supply is irrelevant to the phase sequence.

Installing an AC Reactor

If the Inverter is connected to a large-capacity power transformer (600 kW or more) or the phase advancing capacitor is switched, an excessive peak current may flow through the input power circuit, causing the converter unit to break down.

To prevent this, install an optional AC Reactor on the input side of the Inverter or a DC reactor to the DC reactor connection terminals.

This also improves the power factor on the power supply side.

Installing a Surge Absorber

Always use a surge absorber or diode for inductive loads near the Inverter. These inductive loads include magnetic contactors, electromagnetic relays, solenoid valves, solenoids, and magnetic brakes.

Wiring the Power Terminals of Inverters with 18.5 to 75 kW Outputs

- For 200 V class Inverters of 18.5 to 75 kW or 400 V class Inverters of 18.5 to 45 kW, connect the r and Δ terminals to the R and S terminals respectively. (These are shorted by a short-circuit bar for shipping.)
- For 400 V class, 55, 75 kW, connect the r and Δ 400 terminals to the R and S terminals respectively. (These are shorted by a short-circuit bar for shipping.)

Installing a Noise Filter on Power Supply Side

Install a noise filter to eliminate noise transmitted between the power line and the Inverter.

- Wiring Example 1

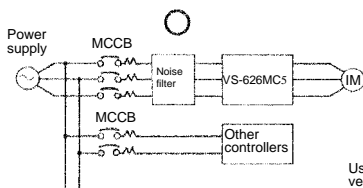

Use a special-purpose noise filter for Inverters.

Fig 3.8 Correct Power supply Noise Filter Installation

- Wiring Example 2

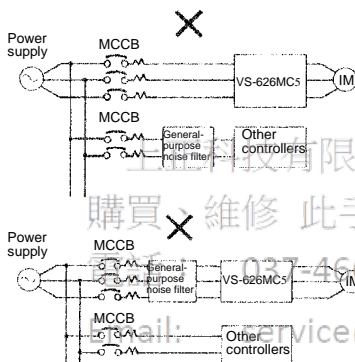

Do not use general-purpose noise filters. No general-purpose noise filter can effectively suppress noise generated from the Inverter.

Fig 3.9 Incorrect Power supply Noise Filter Installation

www.repairtw.com

■ Wiring on the Output Side of Main Circuit

Connecting the Inverter and Motor

Connect output terminals U, V, and W to motor lead wires U, V, and W, respectively.

Check that the motor rotates forward with the forward run command. Switch over any two of the output terminals to each other and reconnect if the motor rotates in reverse with the forward run command.

Never Connect a Power Supply to Output Terminals

Never connect a power supply to output terminals U, V, and W. If voltage is applied to the output terminals, the internal circuits of the Inverter will be damaged.

Never Short or Ground Output Terminals

If the output terminals are touched with bare hands or the output wires come into contact with the Inverter casing, an electric shock or grounding will occur. This is extremely hazardous. Do not short the output wires.

Do Not Use a Phase Advancing Capacitor or Noise Filter

Never to connect a phase advancing capacitor or LC/RC noise filter to an output circuit. Doing so may result in damage to the Inverter or cause other parts to burn.

Do Not Use an Electromagnetic Switch or Magnetic Contactor

Do not connect an electromagnetic switch or magnetic contactor to an output circuit. If a load is connected to the Inverter during operation, a surge current will actuate the overcurrent protective circuit in the Inverter.

Installing a Thermal Overload Relay

This Inverter has an electronic thermal protection function to protect the motor from overheating. If, however, more than one motor is operated with one Inverter or a multi-polar motor is used, always install a thermal relay (THR) between the Inverter and the motor and set L1-01 to 0 (no motor protection).

Set the thermal overload relay to the value on the motor nameplate when operating at 50 Hz and to 1.1 times the value on the nameplate when operating at 60 Hz. The sequence should be designed so that the contacts of the thermal overload relay turn OFF the magnetic contactor on the main circuit inputs.

Installing a Noise Filter on Output Side

Connect a noise filter to the output side of the Inverter to reduce radio noise and inductive noise.

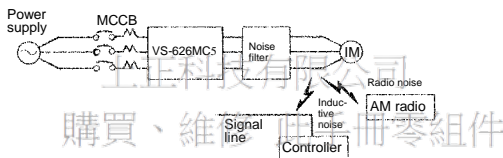

Inductive Noise: Electromagnetic induction generates noise on the signal line, causing the controller to malfunction.

Radio Noise: Electromagnetic waves from the Inverter and cables cause the broadcasting radio receiver to make noise.

Fig 3.10 Installing a Noise Filter on the Output Side

Countermeasures Against Inductive Noise

As described previously, a noise filter can be used to prevent inductive noise from being generated on the output side. Alternatively, cables can be routed through a grounded metal pipe to prevent inductive noise. Keeping the metal pipe at least 30 cm away from the signal line considerably reduces inductive noise.

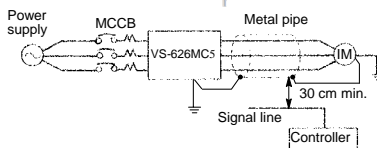

Fig 3.11 Countermeasures Against Inductive Noise

Countermeasures Against Radio Interference

Radio noise is generated from the Inverter as well as from the input and output lines. To reduce radio noise, install noise filters on both input and output sides, and also install the Inverter in a totally enclosed steel box.

The cable between the Inverter and the motor should be as short as possible.

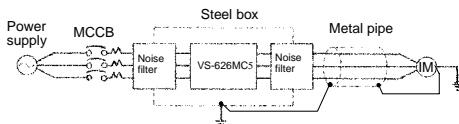

Fig 3.12 Countermeasures Against Radio Interference

Cable Length between Inverter and Motor

If the cable between the Inverter and the motor is long, the high-frequency leakage current will increase, causing the Inverter output current to increase as well. This may affect peripheral devices. To prevent this, adjust the carrier frequency (set in C6-01) as shown in Table 3.6. (For details, refer to the user constant settings.)

Table 3.6 Cable Length between Inverter and Motor

Cable length	50 m max.	100 m max.	More than 100 m
Carrier frequency	15 kHz max.	10 kHz max.	5 kHz max.
(Set value: C6-01)	(15.0)	(10.0)	(5.0)

Ground Wiring

- Always use the ground terminal of the 200 V Inverter with a ground resistance of less than 100 Ω and that of the 400 V Inverter with a ground resistance of less than 10 Ω .
- Do not share the ground wire with other devices, such as welding machines or power tools.
- Always use a ground wire that complies with technical standards on electrical equipment and minimize the length of the ground wire.
Leakage current flows through the Inverter. Therefore, if the distance between the ground electrode and the ground terminal is too long, potential on the ground terminal of the Inverter will become unstable.
- When using more than one Inverter, be careful not to loop the ground wire.

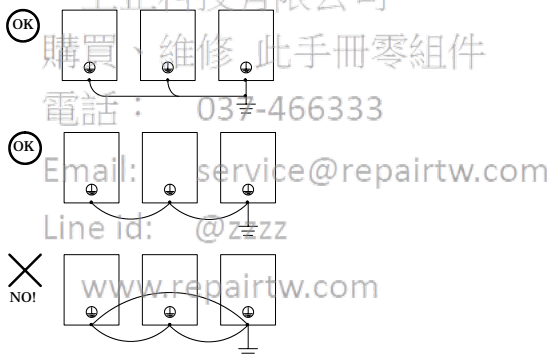
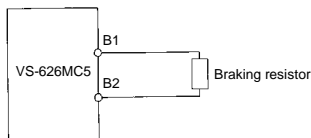

Fig 3.13 Ground Wiring

■ Connecting the Braking Resistor (ERF)

Connect the braking resistor as shown in *Figure 3.14*. When using a Braking Resistor Unit.

L8-01	Protect selection for internal DB resistor (Type ERF)	0: Disabled (no overheating protection) 1: Enabled (overheating protection)
L3-04	Stall prevention selection during decel	0: Disabled (Deceleration as set. If deceleration time is too short, a main circuit overvoltage may result.) 1: Enabled (Deceleration is stopped when the main circuit voltage exceeds the overvoltage level. Deceleration restarts when voltage is returned.) 2: Intelligent deceleration mode (Deceleration rate is automatically adjusted so that in Inverter can decelerate in the shortest possible time. Set deceleration time is disregarded.) 3: Enabled (with Braking Resistor Unit) When a braking option (Braking Resistor, Braking Resistor Unit, Braking Unit) is used, always set to 0 or 3.



The braking resistor connection terminals are B1 and B2. Do not connect to any other terminals. Connecting to any terminals other than B1 or B2 can cause the resistor to overheat, resulting in damage to the equipment.

Fig 3.14 Connecting the Braking Resistor

■ Connecting the Braking Resistor Unit (LKEB) and Braking Unit (CDBR)

Connect the Braking Resistor Unit and Braking Unit to the Inverter as shown in the *Figure 3.15*. Using the Inverter with the Braking Resistor Unit connected.

L8-01	Protect selection for internal DB resistor (Type ERF)	0: Disabled (no overheating protection) 1: Enabled (overheating protection)
L3-04	Stall prevention selection during decel	0: Disabled (Deceleration as set. If deceleration time is too short, a main circuit overvoltage may result.) 1: Enabled (Deceleration is stopped when the main circuit voltage exceeds the overvoltage level. Deceleration restarts when voltage is returned.) 2: Intelligent deceleration mode (Deceleration rate is automatically adjusted so that in Inverter can decelerate in the shortest possible time. Set deceleration time is disregarded.) 3: Enabled (with Braking Resistor Unit) When a braking option (Braking Resistor, Braking Resistor Unit, Braking Unit) is used, always set to 0 or 3.

Set L8-01 to "1" before operating the Inverter with the braking resistor without thermal overload relay trip contacts.

The Braking Resistor Unit cannot be used and the deceleration time cannot be shortened by the Inverter if L3-04 is set to "1" (i.e., if stall prevention is enabled for deceleration).

To prevent the Unit from overheating, design the sequence to turn OFF the power supply for the thermal overload relay trip contacts of the Unit as shown in *Figure 3.15*.

200 V Class Inverters with 3.7 to 7.5 kW Output and 400 V Class Inverters with 3.7 to 15 kW Output

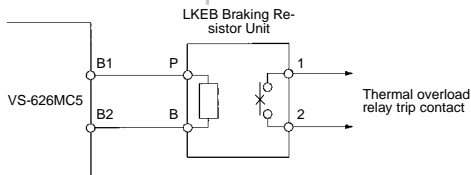

200 V Class Inverters with 11 kW or higher Output and 400 V Class Inverters with 18.5 or higher Output

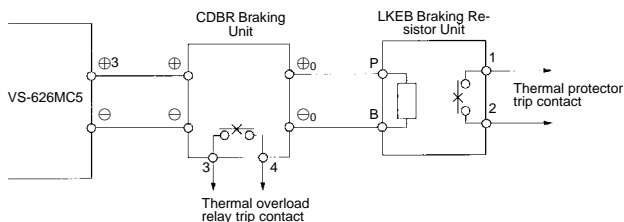

Fig 3.15 Connecting the Braking Resistor Unit and Braking Unit

Connecting Braking Units in Parallel

When connecting two or more Braking Units in parallel, use the wiring and connectors shown in *Figure 3.16*. There are connectors for selecting whether each Braking Unit is to be a Master or Slave. Select "Master" for the first Braking Unit only, and select "Slave" for all other Braking Units (i.e., from the second Unit onwards).

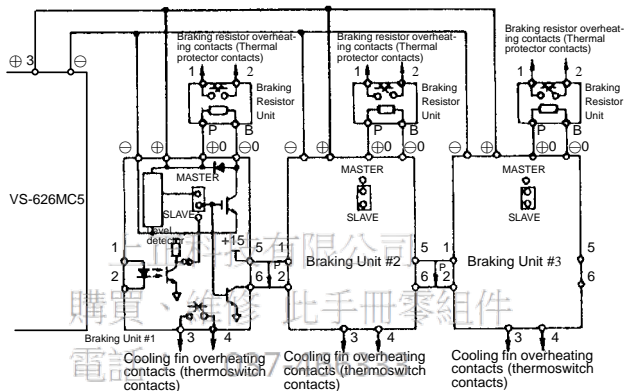

Fig 3.16 Connecting Braking Units in Parallel

Email: service@repairtw.com

Line id: @zzzz

www.repairtw.com

Power Supply Sequence

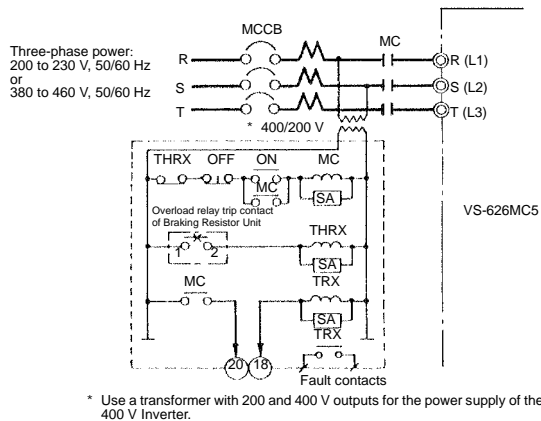

Fig 3.17 Power Supply Sequence

上正科技有限公司

購買、維修 此手冊零組件

電話： 037-466333

Email: service@repairtw.com

Line id: @zzzz

www.repairtw.com

3.5 Wiring Control Circuit Terminals

A control signal line must not be longer than 50 m and must be separated from power lines.

The frequency reference must be input to the Inverter through twisted-pair wires.

3.5.1 Wire Sizes and Closed-loop Connectors

Terminal numbers and wire sizes are shown in *Table 3.7*.

Terminals	Terminal Screws	Wire Thickness [mm ²]	Wire Type
1 to 11 13 to 33	M3.5	Stranded wire: 0.5 to 1.25 Single wire: 0.5 to 1.25	<ul style="list-style-type: none"> Shielded, twisted-pair wire Shielded, polyethylene-covered, vinyl sheath cable
12 (G)	M3.5	0.5 to 2	

The closed-loop connectors and tightening torques for various wire sizes are shown in *Table 3.8*.

Wire Thickness [mm ²]	Terminal Screws	Crimp Size	Tightening Torque (N m)
0.5	M3.5	1.25 to 3.5	0.8
0.75		1.25 to 3.5	
1.25		1.25 to 3.5	
2		2 to 3.5	

上正科技有限公司

購買、維修 此手冊零組件

電話： 037-466333

Email: service@repairtw.com

Line id: @zzzz

www.repairtw.com

3.5.2 Control Circuit Terminal Functions

The functions of the control circuit terminals are shown in *Table 3.9*. Use the appropriate terminals for the correct purposes.

Table 3.9 Control Circuit Terminals

Type	No.	Signal Name	Function	Signal Level
Sequence input signals	1	Forward run/stop command	Forward run when CLOSED; stopped when OPEN.	24 VDC, 8 mA Photocoupler isolation
	2	Reverse run/stop command	Reverse run when CLOSED; stopped when OPEN.	
	3	External fault input	Fault when CLOSED; normal when OPEN.	
	4	Fault reset	Reset when CLOSED	
	5	Multi-step speed reference 1 (Master/auxiliary switch)	Auxiliary frequency reference when CLOSED.	
	6	Multi-step speed reference 2	Multi-step setting 2 when CLOSED.	
	7	Jog frequency reference	Jog run when CLOSED.	
	8	External baseblock	Inverter output stopped when CLOSED.	
	11	Sequence input common	—	
Analog input signals	15	15 V power output	15 V power supply for analog references	15 V (Max. current: 20 mA)
	33	-15 V power output	-15 V power supply for analog references	-15 V (Max. current: 20 mA)
	13	Master speed frequency reference	-10 to 10 V/-100% to 100% 0 to 10 V/100%	-10 to 10 V (20 k Ω), 0 to 10 V (20 k Ω)
	14		4 to 20 mA/100%, -10 to +10 V/-100% to 100% 0 to +10 V/100%	4 to 20 mA (250 Ω)
	16	Multi-function analog input	-10 to 10 V/-100% to 100% 0 to 10 V/100%	Auxiliary analog input (H3-05) -10 to 10 V (20 k Ω), 0 to 10 V (20 k Ω)
	17	Control common	—	—
12	Shield wire, optional ground line connection point	—	—	
Sequence output signals	9	Running signal (1NO contact)	Operating when CLOSED.	Dry contacts Contact capacity: 1 A max. at 250 VAC 1 A max. at 30 VDC
	10			
	25	Zero speed detection	Zero level (b2-01) or below when CLOSED.	Open-collector output 50 mA max. at 48 V*
	26	Speed agree detection	Within ± 2 Hz of set frequency when CLOSED.	
	27	Open-collector output common		
	18			
19	Fault output signal (SPDT)	Fault when CLOSED across 18 and 20 Fault when OPEN across 19 and 20	Dry contacts Contact capacity: 1 A max. at 250 VAC 1 A max. at 30 VDC	
20				
Analog output signals	21	Frequency output	0 to 10 V/100% frequency	Multi-function analog monitor 1 (H4-01, H4-02) 0 to 10 V max. 5% 2 mA max.
	22	Common		
	23	Current monitor	5 V/Inverter's rated current	

* When driving an L load, such as a relay coil, always insert a flywheel diode as shown in *Figure 3.18*.

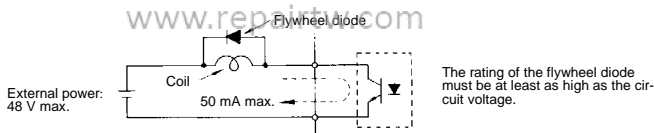

Fig 3.18 Flywheel Diode Connection

11	12(G)	13	14	15	16	17	25	26	27	33	18	19	20
1	2	3	4	5	6	7	8	21	22	23	9	10	

Fig 3.19 Control Circuit Terminal Arrangement

3.5.3 Control Circuit Terminal Connections (All Models)

Connections to VS-626MC5 control circuit terminals are shown in Figure 3.20.

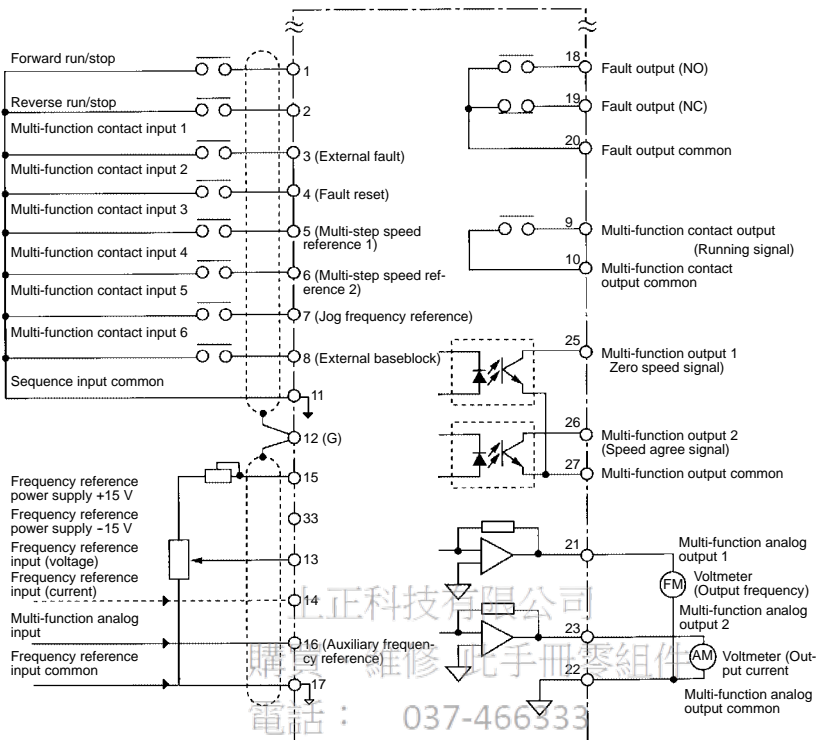

Factory presets are shown in parentheses.

When driving an L load, such as a relay coil, always insert a flywheel diode as shown in Figure 3.18.

Fig. 3.20 Control Circuit Terminal Connections

Line id: @zzz

www.repairtw.com

3.5.4 Control Circuit Wiring Precautions

- Separate control circuit wiring (terminals 1 to 33) from main circuit wiring (terminals R, S, T, B1, B2, U, V, W, $\oplus 1$, $\oplus 2$, and $\oplus 3$) and other high-power lines.
- Separate wiring for control circuit terminals 9, 10, 18, 19, and 20 (contact outputs) from wiring for terminals 1 to 8, 21, 22, 23, 25, 26, 27, 33 and 11 to 17.
- Use twisted-pair or shielded twisted-pair cables for control circuits to prevent operating faults. Process cable ends as shown in *Figure 3.21*.
- Connect the shield wire to terminal 12(G).
- Insulate the shield with tape to prevent contact with other signal lines and equipment.

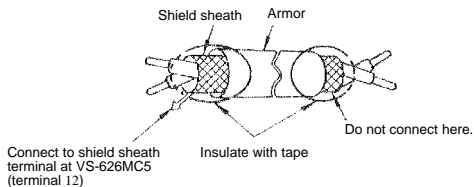

Fig 3.21 Processing the Ends of Twisted-pair Cables

3.6 Wiring Check

Check all wiring after wiring has been completed. Do not perform a buzzer check on control circuits.

- Is all wiring correct?
- Have any wire clippings, screws, or other foreign material been left?
- Are all screws tight?
- Are any wire ends contacting other terminals?

上正科技有限公司

購買、維修 此手冊零組件

電話： 037-466333

Email: service@repairtw.com

Line id: @zzzz

www.repairtw.com

3.7 Installing and Wiring PG Speed Control Cards

PG Speed Control Cards are used for executing speed control using a pulse generator (PG). There are four types of PG speed control, as shown below. Select the type that fits the application and control method.

PG-B2	A/B-phase pulse input for open collector output or complementary outputs, for vector control
PG-X2	A/B/Z-phase pulse input for line driver input, for vector control

3.7.1 Installing a PG Speed Control Card

Use the following procedure to install a PG Speed Control Card.

1. Turn off the main-circuit power supply.
2. Leave it off for at least one minute before removing the front cover of the Inverter (or at least three minutes for Inverters of 30 kW or more). Check to be sure that the CHARGE indicator is OFF.
3. Insert the spacer (which is provided) into the spacer hole in the Inverter's mounting base.
For Inverters of 3.7 kW or lower, there are two adjacent holes. Insert the spacer into the 7CN hole. The spacer cannot be easily removed if inserted into the wrong hole. Be very careful to insert the spacer into the correct hole, and in the proper direction.
4. Referring to the enlarged illustration in the following diagram, align the PG Speed Control Card with the catch position as shown by (a) and (b) and fit it precisely to the Option-A connector. Insert at (a) first.
5. Pass the spacer through the spacer hole at the Card. (Refer to A in the illustration.) Check to be sure that it is precisely aligned with the 4CN position, and snap it into the proper position. Be sure to press it in firmly until you hear it snap into place.

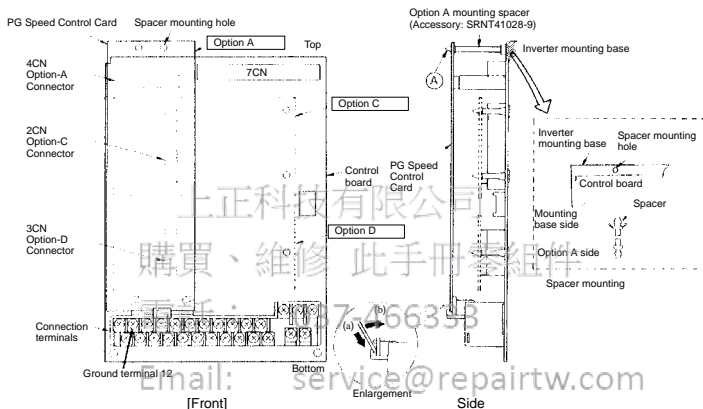

Fig. 3.22 Installing a PG Speed Control Card

www.repairtw.com

3.7.2 PG Speed Control Card Terminal Blocks

The terminal specifications for each PG Speed Control Card are given in the following tables.

■ PG-B2 (For Flux Vector Control Mode Only)

Table 3.10 PG-B2 Terminal Specifications

Terminal	No.	Contents	Specifications
TA1	1	Power supply for pulse generator	12 VDC ($\pm 5\%$), 200 mA max.
	2		0 VDC (GND for power supply)
	3	A-phase pulse input terminal	H: +8 to 12 V L: +1 V max. (Maximum response frequency: 30 kHz)
	4		Pulse input common
	5	B-phase pulse input terminal	H: +8 to 12 V L: +1 V max. (Maximum response frequency: 30 kHz)
	6		Pulse input common
TA2	1	A-phase monitor output terminal	Open collector output, 24 VDC, 30 mA max.
	2	B-phase monitor output terminal	A-phase monitor output common
	3		Open collector output, 24 VDC, 30 mA max.
	4	B-phase monitor output common	
TA3	(E)	Shield connection terminal	

■ PG-X2 (For Flux Vector Control Mode Only)

Table 3.11 PG-X2 Terminal Specifications

Terminal	No.	Contents	Specifications
TA1	1	Power supply for pulse generator	12 VDC ($\pm 5\%$), 200 mA max. (see note)
	2		0 VDC (GND for power supply)
	3		5 VDC ($\pm 5\%$), 200 mA max. (see note)
	4	A-phase + input terminal	Line driver input (RS-422 level input) Maximum response frequency: 300 kHz
	5	A-phase - input terminal	
	6	B-phase + input terminal	
	7	B-phase - input terminal	
	8	Z-phase + input terminal	
	9	Z-phase - input terminal	
	10	Common terminal	
TA2	1	A-phase + output terminal	Line driver output (RS-422 level output)
	2	A-phase - output terminal	
	3	B-phase + output terminal	
	4	B-phase - output terminal	
	5	Z-phase + output terminal	
	6	Z-phase - output terminal	
	7	Control circuit common	Control circuit GND
TA3	(E)	Shield connection terminal	

Note 5 VDC and 12 VDC cannot be used at the same time.

3.7.3 Wiring a PG Speed Control Card

Wiring examples are provided in the following illustrations for the PG Speed Control Cards.

■ PG-B2 (For Flux Vector Control Mode Only)

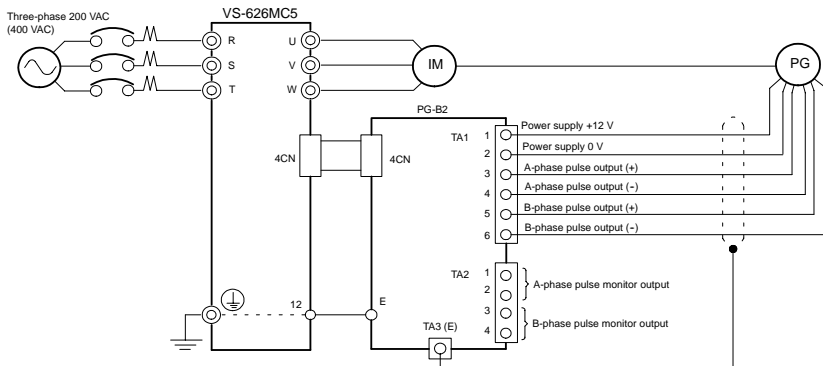

- Shielded twisted-pair wires must be used for signal lines.
- Do not use the pulse generator's power supply for anything other than the pulse generator (encoder). Using it for another purpose can cause malfunctions due to noise.
- The length of the pulse generator's wiring must not be more than 100 meters.
- The direction of rotation of the PG can be set in user constant F1-05. The factory preset is for forward rotation, A-phase advancement.

Fig 3.23 PG-B2 Wiring

I/O Circuit Configuration

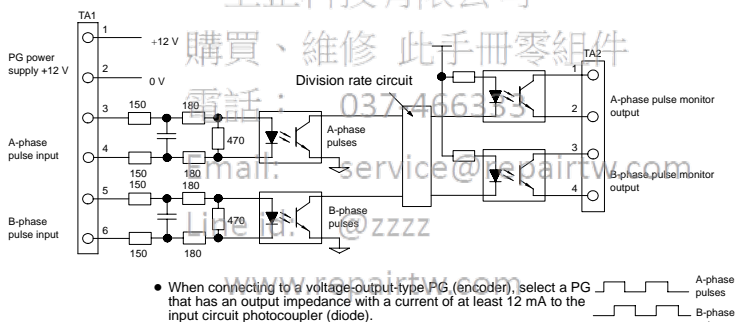

- When connecting to a voltage-output-type PG (encoder), select a PG that has an output impedance with a current of at least 12 mA to the input circuit photocoupler (diode).

Fig 3.24 I/O Circuit Configuration of the PG-B2

■ PG-X2 (For Flux Vector Control Mode Only)

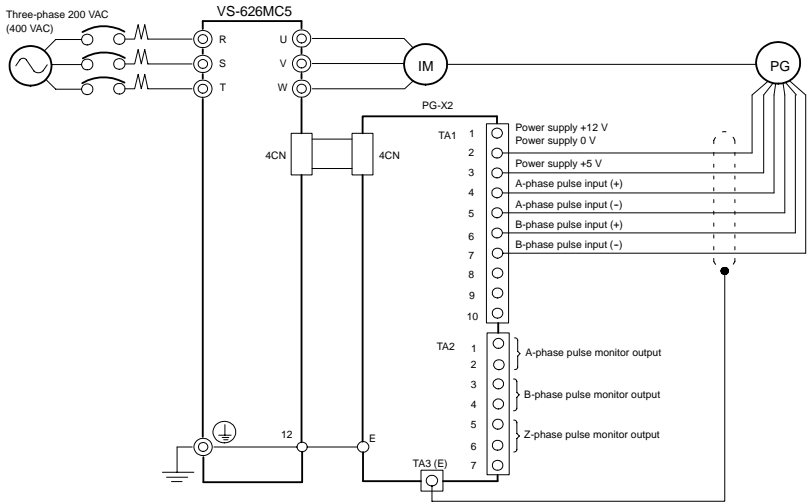

- Shielded, twisted-pair wire must be used for signal lines.
- Do not use the pulse generator's power supply for anything other than the pulse generator (encoder). Using it for another purpose can cause malfunctions due to noise.
- The length of the pulse generator's wiring must not be more than 100 meters.
- The direction of rotation of the PC can be set in user constant F1-05. The factory preset is for forward rotation, A-phase advancement.

Fig 3.25 PG-X2 Wiring

購買、維修 此手冊零組件

電話： 037-466333

Email: service@repairtw.com

Line id: @zzzz

www.repairtw.com

3.7.4 Wiring PG Speed Control Card Terminal Blocks

Use no more than 100 meters of wiring for PG (encoder) signal lines, and keep them separate from power lines.

Use shielded, twisted-pair wires for pulse inputs and pulse output monitor wires, and connect the shield to the shield connection terminal.

■ Wire Sizes (Same for All Models)

Terminal wire sizes are shown in *Table 3.12*.

Table 3.12 Wire Sizes

Terminal	Terminal Screws	Wire Thickness mm ²	Wire Type
Pulse generator power supply Pulse input terminal Pulse monitor output terminal		Stranded wire: 0.5 to 1.25 Single wire: 0.5 to 1.25	<ul style="list-style-type: none"> Shielded, twisted-pair wire Shielded, polyethylene-covered, vinyl sheath cable
Shield connection terminal	M3.5	0.5 to 2	

■ Solderless Terminals for Control Circuit Terminals

The use of solderless terminals for the control circuit terminals is recommended because solderless terminals are easy to connect securely.

Table 3.13 Straight Solderless Terminal Sizes

Wire Thickness	Model	d1	d2	Manufacturer
0.5 mm ²	A1 0.5-8 WH	1.00	2.60	Phoenix Contact
0.75mm ²	A1 0.75-8 GY	1.20	2.80	
1 mm ²	A1 1-8 RD	1.40	3.00	
1.5 mm ²	A1 1.5-8 BK	1.70	3.50	

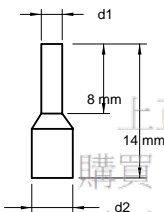

Fig. 3.26 Straight Solderless Terminal Sizes

NOTE

Do not solder wires with the control circuit terminals if wires are used instead of solderless terminals.

Wires may not contact well with the control circuit terminals or the wires may be disconnected from the control circuit terminals due to oscillation if the wires are soldered.

■ Closed-loop Connector Sizes and Tightening Torque

The closed-loop connectors and tightening torques for various wire sizes are shown in *Table 3.14*.

Table 3.14 Closed-loop Connectors and Tightening Torques

Wire Thickness [mm ²]	Terminal Screws	Crimp Terminal Size	Tightening Torque (N·m)
0.5	M3.5	1.25 to 3.5	0.8
0.75		1.25 to 3.5	
1.25		1.25 to 3.5	
2		2 to 3.5	

■ Wiring Method

Use the following procedure to connect wires to the terminal block.

1. Loosen the terminal screws with a thin-slot screwdriver.
2. Insert the wires from underneath the terminal block.
3. Tighten the terminal screws firmly.

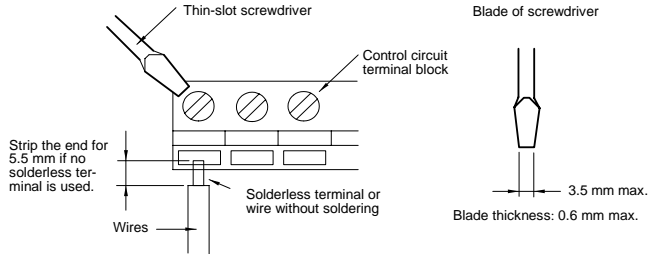

Fig 3.27 Connecting Wires to Terminal Block

NOTE

Wiring Precautions

1. Separate PG Speed Control Card control circuit wiring (terminals TA1 and TA2) from main circuit wiring and other high-power lines.
2. Use twisted-pair or shielded twisted-pair cables to connect the PG to prevent operating faults. Process cable ends as shown in *Figure 3.28*. The maximum cable length is 100 m.

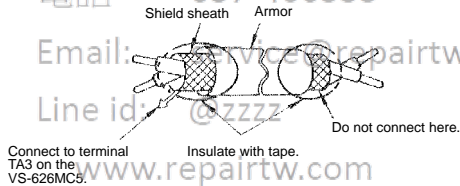

Fig 3.28 Processing the Ends of Twisted-pair Cables

3. Connect the shield to the ground terminal.
4. Do not solder the wires to the control circuit terminals. The wires may not contact well with the control circuit terminals if the wires are soldered.
5. The end of each wire connected to the control circuit terminals must be stripped for approximately 5.5 mm.

3.7.5 Selecting the Number of PG (Encoder) Pulses

■ PG-B2

The maximum response frequency is 32,767 Hz.

Use a PG that outputs a maximum frequency of approximately 20 kHz for the rotational speed of the motor.

$$\text{Motor speed at maximum frequency output (r/min)} \times \frac{\text{PG rating (p/rev)}}{60} = 20,000 \text{ Hz}$$

Some examples of PG output frequency (number of pulses) for the maximum frequency output are shown in Table 3.15.

Table 3.15 PG Pulse Selection Examples

Motor's Maximum Speed r/min	PG Rating p/rev	PG Output Frequency for Maximum Frequency Output Hz
1800	600	18,000
1500	800	20,000
1200	1000	20,000
900	1200	18,000

Note 1. The motor speed at maximum frequency output is expressed as the sync rotation speed.

2. The PG power supply is 12 V.

3. A separate power supply is required if the PG power supply capacity is greater than 200 mA. (If momentary power loss must be handled, use a backup capacitor or other method.)

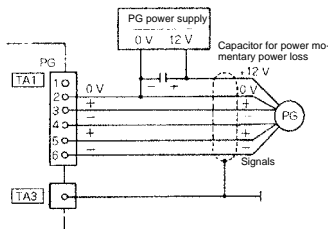

Fig. 3.29 PG-B2 Connection Example

■ PG-X2

Both 12V and 15V are available as PG power supply. Verify the PG power supply specifications before connection.

The maximum response frequency is 300 kHz.

Use the following equation to compute the output frequency of the PG (f_{PG}).

$$f_{PG} \text{ (Hz)} = \frac{\text{Motor speed at maximum frequency output (r/min)} \times \text{PG rating (p/rev)}}{60}$$

A separate power supply is required if the PG power supply capacity is greater than 200 mA. (If momentary power loss must be handled, use a backup capacitor or other method.)

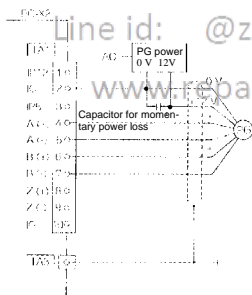

Fig. 3.30 PG-X2 Connection Example

4

Setting User Constants

This chapter describes setting user constants using the Digital Operator.

4.1 Using the Digital Operator	4 - 2
4.2 Modes	4 - 4
4.2.1 Inverter Modes	4 - 4
4.2.2 Switching Modes	4 - 5
4.2.3 User Constant Access Levels	4 - 6
4.2.4 Operation Mode	4 - 11
4.2.5 Initialize Mode	4 - 18
4.2.6 Programming Mode	4 - 26
4.2.7 Autotuning Mode	4 - 29
4.2.8 Modified Constants Mode	4 - 31

上正科技有限公司

購買、維修 此手冊零組件

電話： 037-466333

Email: service@repairtw.com

Line id: @zzzz

www.repairtw.com

4.1 Using the Digital Operator

This section describes the component names and functions of the Digital Operator. The component names and functions are shown in *Figure 4.1* and Key functions are described in *Table 4.1*.

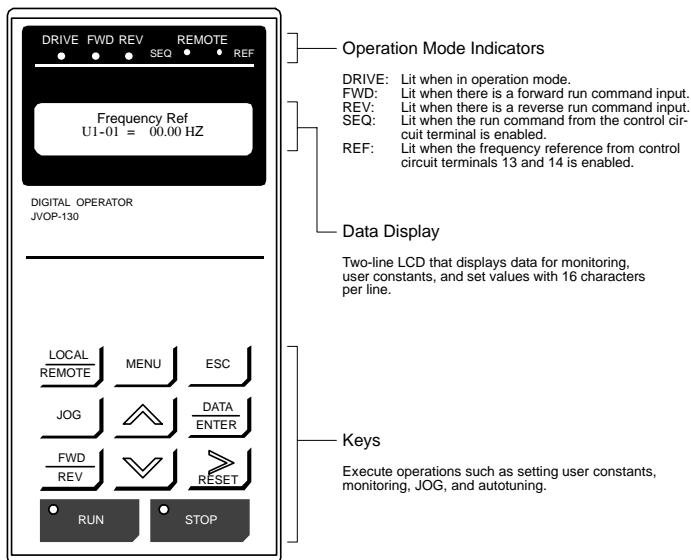

Fig 4.1 Digital Operator Component Names and Functions

購買、維修 此手冊零組件











電話： 037-466333

Email: service@repairtw.com

Line id: @zzzz

www.repairtw.com

Table 4.1 Key Functions

Key	Name	Function
	LOCAL/REMOTE Key	Switches between operation (LOCAL) via the Digital Operator and control circuit terminal (REMOTE) operation. This Key can be enabled or disabled by setting a user constant (o2-01).
	MENU Key	Displays menus.
	ESC Key	Returns to the status before the DATA/ENTER Key was pressed.
	JOG Key	Enables jog operation when the VS-626MC5 is being operated from the Digital Operator.
	FWD/REV Key	Selects the rotation direction of the motor when the VS-626MC5 is being operated from the Digital Operator.
	RESET Key	Sets the number of digits for user constant settings. Also acts as the reset Key when a fault has occurred.
	Increment Key	Selects menu items, groups, functions, and user constant names, and increments set values.
	Decrement Key	Selects menu items, groups, functions, and user constant names, and decrements set values.
	DATA/ENTER Key	Enters menu items, functions, constants, and set values after they are set.
	RUN Key	Starts the VS-626MC5 operation when the VS-626MC5 is in operation with the Digital Operator.
	STOP Key	Stops VS-626MC5 operation. This Key can be enabled or disabled by setting a user constant (o2-02) when operating from the control circuit terminal.

Note Except in diagrams, Keys are referred to using the Key names listed in the above table.

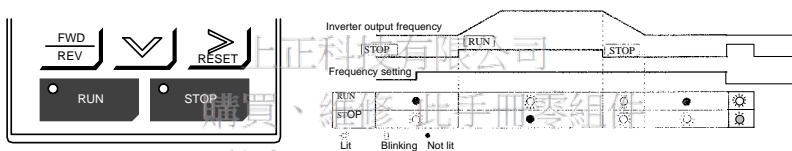

The RUN and STOP indicators light and blink to indicate operating status.

Fig 4.2 RUN and STOP Indicators

Email: service@repairtw.com

Line id: @zzzz

www.repairtw.com

4.2 Modes

This section describes the VS-626MC5's monitor modes, switching between modes, and accessing/setting user constants.

4.2.1 Inverter Modes

The VS-626MC5 Inverter's user constants and monitoring functions have been organized in groups called modes that make it easier to read and set user constants.

The VS-626MC5 is equipped with 5 modes, as shown in the *Table 4.2*.

Table 4.2 Modes

Mode	Primary function(s)
Operation mode	The Inverter can be run in this mode. Use this mode when monitoring values such as frequency references or output current, displaying fault information, or displaying the fault history.
Initialize mode	Use this mode when selecting the language displayed on the Digital Operator, selecting the access level for reading/setting user constants, selecting the control mode, or initializing the user constants.
Programming mode	Use this mode when reading/setting the user constants required for operation. The program-mode functions are subdivided into the following groups: <ul style="list-style-type: none"> • Application: Operation mode selection, DC control, speed search, etc. • Tuning: Acceleration/deceleration times, S-curve characteristics, carrier frequencies, etc. • Reference: Settings related to frequency control • Motor: V/f characteristics and motor constants • Option: Settings for Optional Cards • Terminal: Settings for sequential I/O and analog I/O • Protection: Settings for the motor and inverter protection functions • Operator: Selects the Digital Operator's display and Key functions • Winding : Settings for winding change function (Optional)
Autotuning mode	(Usable only with in vector control mode) Use this mode when running a motor with unknown motor constants in the vector control mode. The motor constants are calculated and set automatically. Perform autotuning for motor unit separately before vector control operation.
Modified constants mode (See note)	Use this mode to read/set user constants that have been changed from their factory-set values.

Note Always perform autotuning for motor unit separately before vector control operation.

購買、維修 此手冊零組件

電話： 037-466333

Email: service@repairtw.com

Line id: @zzzz

www.repairtw.com

4.2.2 Switching Modes

Once the Inverter has been put into operation mode by pressing the Menu Key, the Increment and Decrement Keys can be pressed to switch to other modes. Press the DATA/ENTER Key to read/set the user constants in each mode.

Press the ESC Key to return to the mode display from the user constant display.

Press the DATA/ENTER Key twice to write a constant and then press the ESC Key to return to the mode display. This is the most Basic operation, so you should remember it.

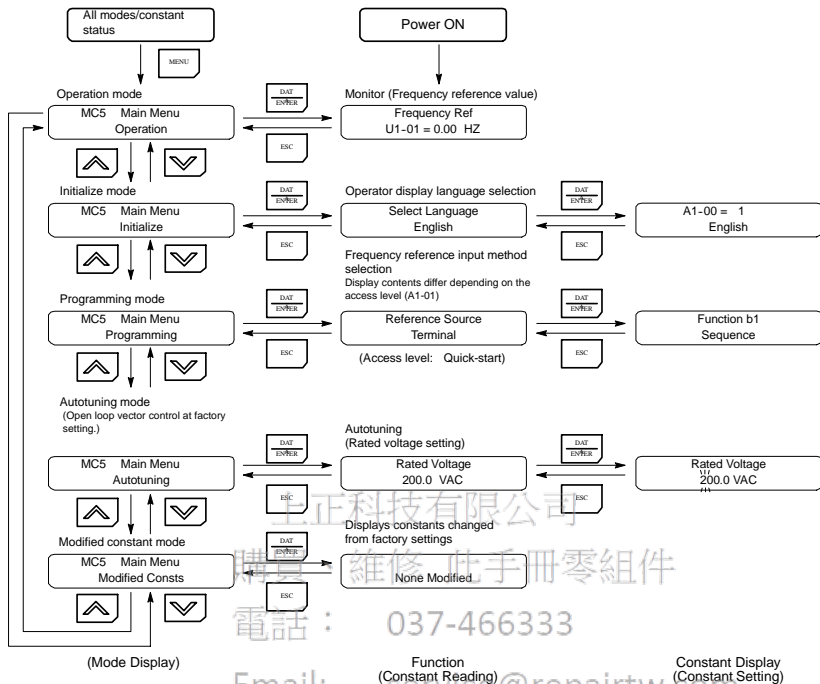

Fig 4.3 Mode Transitions

IMPORTANT

When running the Inverter after using digital operator, press the MENU Key to enter the operation mode and then press the DATA/ENTER Key from the operation mode display to bring up the monitor display. Run commands can't be received from any other display. (Monitor display in the operation mode appears when the power is turned ON.)

4.2.3 User Constant Access Levels







The VS-626MC5 has three access levels which divide the various user constants based on their applications, as shown below. The access level restricts which user constants can be set or displayed.

Quick-start	Allows reading/setting of user constants required for simple operation. (factory preset)
Basic	Allows reading/setting of Basic user constants.
Advanced	Allows reading/setting of all user constants.

Set the access level in initialize mode with user constant A1-01.

■ Changing the Access Level from Quick-start to Basic

The Inverter is set at the factory to start in the Quick-start access level. Use the following procedure to change from the Quick-start level to the Basic level.

Step	Key Sequence	Digital Operator Display	Remarks
1		MC5 Main Menu Operation	
2		MC5 Main Menu Initialize	
3		Select Language English	
4		Access Level QUICK-START	
5		A1-01 = 2 QUICK-START	
6		A1-01 = 3 Basic	
7		Entry Accepted	
		Access Level Basic	After approx. 3 seconds, the Operator display is as shown on the left.

As shown above, Quick-start has changed to Basic.

These seven steps can be illustrated as when in Figure 4.4.

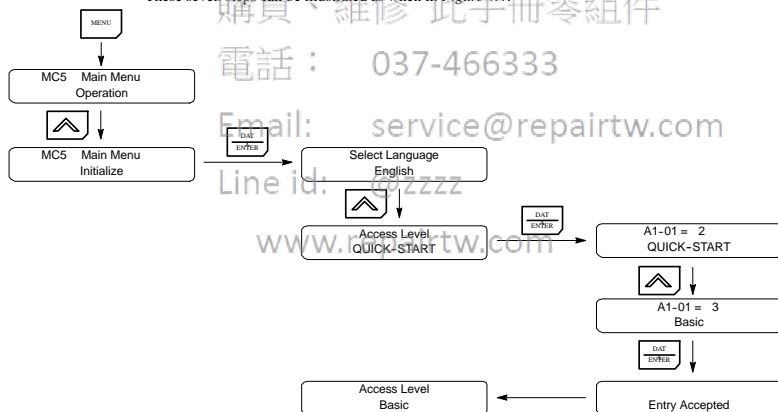

Fig 4.4 Changing Quick-start to Basic

■ Setting User Constants in Each Access Level

The displayed access level will change when programming mode is selected. The display will not change for access levels in operation mode, initialize mode, autotuning mode, and modified constants mode.

This section provides the procedure to change the acceleration time to 20.0 s in each access level. The acceleration time (C1-01) is a user constant in programming mode.

If the new user constant setting is not written to the Unit by pressing the DATA/ENTER Key within one minute after starting the procedure, the display will automatically revert to the original user constant setting. In this case, the procedure must be started again.

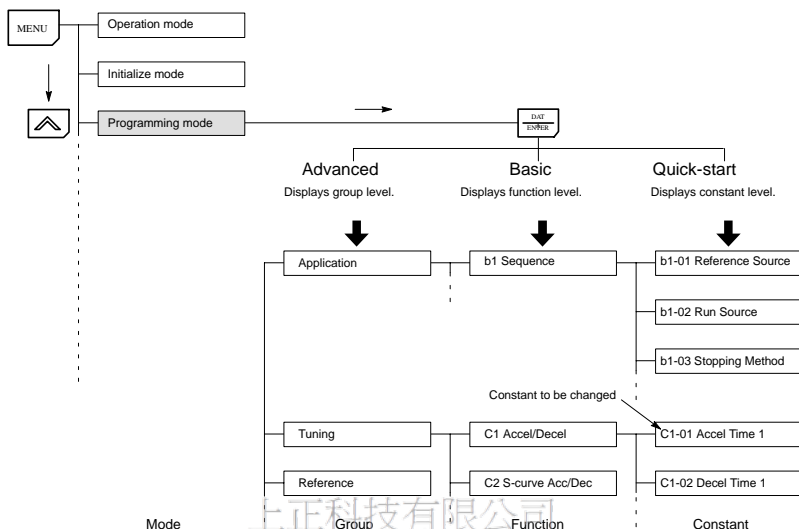

Fig 4.5 Constant Access Levels

上正科技有限公司

電話： 037-466333

Email: service@repairtw.com

Line id: @zzzz

www.repairtw.com

EXAMPLE Setting a User Constant in the Quick-start Access Level

The user constant level will be displayed when the DATA/ENTER Key is pressed at the programming mode display.

Use the following display to set the acceleration time to 20.0 s.

Step	Key Sequence	Digital Operator Display	Remarks
1		MC5 Main Menu Operation	
2	 Press twice.	MC5 Main Menu Programming	
3		Reference source Terminals	Changed to constant setting level.
4		Run Source Terminals	
5		Stopping Method Ramp to Stop	
6		Accel Time 1 C1-01 = 10.0 Sec	
7		Accel Time 1 0010.0 Sec 	Selects the user constant so that the leading 0 blinks. The digit that is blinking can be changed.
8	 Press twice.	Accel Time 1 0010.0 Sec 	Blinking digit moves 2 places to the right.
9		Accel Time 1 0020.0 Sec 	Changes 1 to 2.
10		Entry Accepted	
		Accel Time 1 C1-01 = 20.0 Sec	After approx. 3 seconds, the Operator display is as shown on the left.

The acceleration time has been set to 20.0 seconds.

Step	Key Sequence	Digital Operator Display	Remarks
11		MC5 Main Menu Programming	

Returns to programming mode display.

Email: service@repairtw.com











Line id: @zzzz

www.repairtw.com

◀EXAMPLE▶ Setting a User Constant in the Basic Access Level

The function level will be displayed when the DATA/ENTER Key is pressed at the programming mode display.

Use the following display to set the acceleration time to 20.0 s.

Step	Key Sequence	Digital Operator Display	Remarks
1		MC5 Main Menu Operation	
2	 Press twice.	MC5 Main Menu Programming	
3		Function b1 Sequence	Changed to constant reading (function) level.
4		Function b2 DC Braking	
5		Function C1 Accel/Decel	
6		Accel Time 1 C1-01 = 10.0 Sec	Changed to constant setting level..
7		Accel Time 1 0010.0 Sec 11	Selects the user constant so that the leading 0 blinks. The blinking digit can be changed.
8	 Press twice.	Accel Time 1 0010.0 Sec 11	Blinking digit moves 2 places to the right and the "1" blinks.
9		Accel Time 1 0020.0 Sec 11	Changes 1 to 2.
10		Entry Accepted	Writes-in the new setting.
11		Accel Time 1 C1-01 = 20.0 Sec Function C1 Accel/Decel	The Operator display is as shown on the left.

Returns to "Function C1 Accel/Decel" display.

電話： 037-466333

Email: service@repairtw.com











Line id: @zzzz

www.repairtw.com

◀EXAMPLE▶ Setting a User Constant in the Advanced Access Level

The group level will be displayed when the DATA/ENTER Key is pressed at the programming mode display.

Use the following procedure to set a constant.

Step	Key Sequence	Digital Operator Display	Remarks
1		MC5 Main Menu Operation	
2	 Press twice.	MC5 Main Menu Programming	
3		Group b Application	
4		Group C Tuning	
5		Function C1 Accel/Decel	Changed to constant reading (function) level.
6		Accel Time 1 C1-01 = 10.0 Sec	
7		Accel Time 1 0010.0 Sec "1" blinks	Selects the user constant so that the leading 0 blinks. The blinking digit can be changed.
8	 Press twice.	Accel Time 1 0010.0 Sec "1" blinks	Blinking digit moves 2 places to the right and the "1" blinks.
9		Accel Time 1 0020.0 Sec "1" blinks	Changes 1 to 2.
10		Entry Accepted	Writes-in the new setting, 20.0 s.
		Accel Time 1 C1-01 = 20.0 Sec	After a few seconds, the Operator display is as shown on the left.
11		Function C1 Accel/Decel	

The constant setting in Advanced level (acceleration time change from 10.0 to 20.0 s) has been completed.

電話： 037-466333

Email: service@repairtw.com

Line id: @zzzz

www.repairtw.com

4.2.4 Operation Mode

Operation mode is the mode in which the Inverter can be operated.

Many user constants can't be changed when the Inverter is operating. Refer to *User Constant List* for details.

The following monitor displays are possible in operation mode: The frequency reference, output frequency, output current, and output voltage, as well as fault information and the fault history.

IMPORTANT

When running the Inverter, press the MENU Key first to enter the operation mode and then press the DATA/ENTER Key from the operation mode display to bring up the monitor display. Run commands can't be received from any other display. Once the Inverter is running, it can be switched to other modes.

■ Operations in Operation Mode

Key operations in operation mode are shown in Figure 4.6.

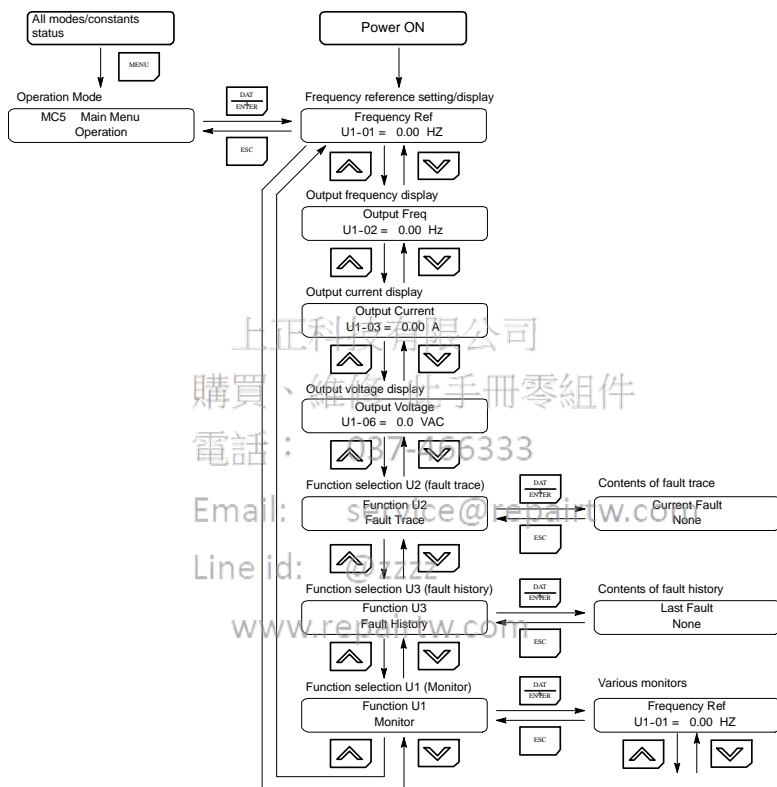

Fig 4.6 Operations in Operation Mode

■ Conditions for Monitoring

Table 4.3 shows the items that can be monitored in operation mode.

The "Valid access levels" column in the table indicates whether an item can be monitored in a particular access level and control method. The codes in this column have the following meanings.

Q	Items that can be monitored in the Quick-start access level only.
B	Items that can be monitored in the Quick-start and Basic access levels.
A	Items that can be monitored in all access levels. (Quick-start, Basic, and Advanced)
	Items that cannot be monitored in the control mode shown.

The output signal levels for multi-function analog outputs shown in the table are for a gain of 100.0 and a bias of 0.00.

Table 4.3 Constants Monitored in Operation Mode

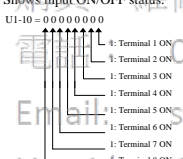
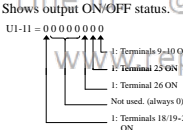
Function	Constant No.	Name Digital Operator Display	Function	Output Signal Levels for Multi-function Analog Outputs	Min. Unit	Valid Access Levels	
						Open Loop Vector	Flux Vector
Status Monitor	U1-01	Frequency reference	Monitors/sets the frequency reference value. The display units can be set with user constant o1-03.	10 V: Max. frequency (0 to ± 10 V possible)	0.01 Hz	Q	Q
		Frequency Ref					
	U1-02	Output frequency	Monitors the output frequency. The display units can be set with user constant o1-03.	10 V: Max. frequency (0 to ± 10 V possible)	0.01 Hz	Q	Q
		Output Freq					
	U1-03	Output current Output Current	Monitors the output current.	10 V: Rated current (0 to +10 V output)	0.1 A	Q	Q
	U1-04	Control method Control Method	Shows which control mode is set.	Can't be output.		Q	Q
	U1-05	Motor speed Motor Speed	Monitors the motor speed.	10 V: Max. frequency (0 to ± 10 V possible)	0.01 Hz	Q	Q
	U1-06	Output voltage Output Voltage	Monitors the Inverter's internal output voltage reference value.	10 V: 200 (400) VAC (0 to +10 V output)	0.1 V	Q	Q
	U1-07	DC bus voltage DC Bus Voltage	Monitors the DC voltage of the Inverter's internal main circuit.	10 V: 400 (800) VDC (0 to +10 V output)	1 V	Q	Q
	U1-08	Output power Output kWatts	Monitors the output power. (This is an internally detected value.)	10 V: Max. motor capacity (0 to ± 10 V possible)	0.1 kW	Q	Q
	U1-09	Torque reference Torque Reference	Monitors the internal torque reference value when vector control is used.	10 V: Rated torque (0 to ± 10 V possible)	0.1 %	Q	Q
U1-10	Input terminal status	Shows input ON/OFF status. U1-10 = 00000000 	Can't be output.		Q	Q	
	Input Term Sts						
U1-11	Output terminal status	Shows output ON/OFF status. U1-11 = 00000000 	Can't be output.		Q	Q	
	Output Term Sts						

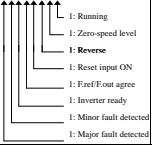
Function	Constant No.	Name	Function	Output Signal Levels for Multi-function Analog Outputs	Min. Unit	Valid Access Levels	
		Digital Operator Display				Open Loop Vector	Flux Vector
Status Monitor	U1-12	Operation status	Inverter operating status. U1-12 = 0 0 0 0 0 0 0 0 	Can't be output.		Q	Q
		Int Ctl Sts 1					
	U1-13	Cumulative operation time	Monitors the Inverter's elapsed operating time.	Can't be output.	1 hr	Q	Q
		Elapsed Time	The initial value and running/power-on time selection can be set with user constants o2-07 and o2-08.				
	U1-14	Software No.	Manufacturer's ID number	Can't be output.		Q	Q
		FLASH ID					
	U1-15	Terminal 13 input voltage level	Monitors the input voltage of the frequency reference (voltage).	10 V: 100% (10 V) (0 to ±10 V possible)	0.1 %	B	B
		Term 13 Level	An input of 10 V corresponds to 100%.				
	U1-16	Terminal 14 input current level	Monitors the input current of the frequency reference (current).	20 mA: 100% (20 mA) (0 to +10 V output)	0.1 %	B	B
		Term 14 Level	An input of 20 mA corresponds to 100%.				
	U1-17	Terminal 16 input voltage level	Monitors the input voltage of the multi-function analog input.	10 V: 100% (10 V) (0 to ±10 V possible)	0.1 %	B	B
		Term 16 Level	An input of 10 V corresponds to 100%.				
	U1-18	Motor secondary current (Iq)	Monitors the calculated value of the motor's secondary current (Iq).	10 V: Rated secondary current (0 to +10 V output)	0.1 %	B	B
		Mot SEC Current	The motor's rated secondary current corresponds to 100%.				
	U1-19	Motor exciting current (Id)	Monitors the calculated value of the motor's excitation current (Id).	10 V: Rated secondary current (0 to +10 V output)	0.1 %	B	B
		Mot EXC Current	The motor's rated secondary current corresponds to 100%.				
	U1-20	Output frequency after soft-start	Monitors the output frequency after a soft start.	10 V: Max. frequency (0 to ±10 V possible)	0.01 Hz	A	A
SFS Output		The display shows the frequency without the correction from compensation functions such as slip compensation.					
U1-21	ASR input	Monitors the input to the speed control loop.	10 V: Max. frequency (0 to ±10 V possible)	0.01 %		A	
	ASR Input	The max. frequency corresponds to 100%.					
U1-22	ASR output	Monitors the output from the speed control loop.	10 V: Rated secondary current (0 to ±10 V possible)	0.01 %		A	
	ASR Output	The motor's rated secondary current corresponds to 100%.					
U1-23	Speed deviation	Monitors the speed deviation within the speed control loop.	10 V: Max. frequency (0 to ±10 V possible)	0.01 %		A	
	Speed Deviation	The max. frequency corresponds to 100%.					

Function	Constant No.	Name	Function	Output Signal Levels for Multi-function Analog Outputs	Min. Unit	Valid Access Levels	
		Digital Operator Display				Open Loop Vector	Flux Vector
Status Monitor	U1-25	DI-16H2 input status	Monitors the reference value from a VS-626MC5-DI16H2 Digital Reference Card. The value will be displayed in binary or BCD depending on user constant F3-01.	Can't be output.		A	A
		DI-16 Reference					
	U1-26	Output voltage reference (Vq)	Monitors the Inverter's internal voltage reference value for the motor's secondary current control.	10 V: 200 (400) VAC (0 to ±10 V possible)	0.1 V	A	A
		Voltage Ref (Vq)					
	U1-27	Output voltage reference (Vd)	Monitors the Inverter's internal voltage reference value for the motor's excitation current control.	10 V: 200 (400) VAC (0 to ±10 V possible)	0.1 V	A	A
		Voltage Ref (Vd)					
	U1-28	Software No. (CPU)	Manufacturer's CPU software ID number	Can't be output.	0.1 V	A	A
		CPU ID					
	U1-32	ACR output of q axis	Monitors current control output value for motor's secondary current.	10 V: 100%	0.1 %	A	A
		ACR (q) Output					
	U1-33	ACR output of d axis	Monitors current control output value for motor's excitation current.	10 V: 100%	0.1 %	A	A
		ACR (d) Output					
U1-34	OPE fault constant	Shows the first constant number where an OPE fault is detected.	Can't be output.		A	A	
	OPE Detected						

上正科技有限公司

購買、維修 此手冊零組件

電話： 037-466333

Email: service@repairtw.com

Line id: @zzzz

www.repairtw.com

Table 4.3 Constants Monitored in Operation Mode (Continued)

Function	Constant No.	Name	Function	Output Signal Levels for Multi-function Analog Outputs	Min. Units	Valid Access Levels		
		Digital Operator Display				Open Loop Vector	Flux Vector	
Fault trace (See note.)	U2-01	Current fault	Information on the current fault	Can't be output.		Q	Q	
		Current Fault						
	U2-02	Last fault	Information on the last fault			Q	Q	
		Last Fault						
	U2-03	Frequency reference at fault	Frequency reference value when the "last fault" occurred.			0.01 Hz	Q	Q
		Frequency Ref						
	U2-04	Output frequency at fault	Output frequency when the "last fault" occurred.			0.01 Hz	Q	Q
		Output Freq						
	U2-05	Output current at fault	Output current when the "last fault" occurred.			0.1 A	Q	Q
		Output Current						
	U2-06	Motor speed at fault	Motor speed when the "last fault" occurred.			0.01 Hz	Q	Q
		Motor Speed						
	U2-07	Output voltage reference at fault	Output voltage when the "last fault" occurred.			0.1 V	Q	Q
		Output Voltage						
	U2-08	DC bus voltage at fault	The main circuit DC voltage when the "last fault" occurred.			1 V	Q	Q
		DC Bus Voltage						
	U2-09	Output power at fault	Output power when the "last fault" occurred.			0.1 kW	Q	Q
		Output kWatts						
	U2-10	Torque reference at fault	Torque reference when the "last fault" occurred. (The rated torque = 100%)			0.1 %	Q	Q
		Torque Reference						
U2-11	Input terminal status at fault	Input terminal status when the "last fault" occurred. (Same format as U1-10.)	Q	Q	Q			
	Input Term Sts							
U2-12	Output terminal status at fault	Output terminal status when the "last fault" occurred. (Same format as U1-11.)	Q	Q	Q			
	Output Term Sts							
U2-13	Operation status at fault	Inverter operating status when the "last fault" occurred. (Same format as U1-12.)	Q	Q	Q			
	Inverter status							
U2-14	Cumulative operation time at fault	Elapsed operating or power-on time when the "last fault" occurred.	1 hr	Q	Q			
	Elapsed time							

Note When faults CPF00, 01, 02, 03, UV1 and UV2 occur, a fault trace is not performed.

www.repairtw.com

Function	Constant No.	Name	Function	Output Signal Levels for Multi-function Analog Outputs	Min. Units	Valid Access Levels	
		Digital Operator Display				Open Loop Vector	Flux Vector
Fault history (See note.)	U3-01	Most recent fault	Information on the last fault.	Can't be output.	1 hr	Q	Q
		Last Fault					
	U3-02	Second most recent fault	Information on the 2 nd to last fault.			Q	Q
		Fault Message 2					
	U3-03	Third most recent fault	Information on the 3 rd to last fault.			Q	Q
		Fault Message 3					
	U3-04	Fourth/oldest fault	Information on the 4 th to last fault.			Q	Q
		Fault Message 4					
	U3-05	Cumulative operation time at fault	Elapsed running or power-on time when the last fault occurred.			Q	Q
		Elapsed Time 1					
	U3-06	Accumulated time of second fault	Elapsed running or power-on time when the 2 nd to last fault occurred.			Q	Q
		Elapsed Time 2					
	U3-07	Accumulated time of third fault	Elapsed running or power-on time when the 3 rd to last fault occurred.			Q	Q
		Elapsed Time 3					
	U3-08	Accumulated time of fourth/oldest fault	Elapsed running or power-on time when the 4 th to last fault occurred.			Q	Q
		Elapsed Time 4					

Note Faults CPF00, 01, 02, 03, UV1 and UV2 are not recorded in the fault history.

■ Monitoring at Startup

In operation mode, the frequency reference, output frequency, output current, and output voltage can be monitored immediately if the factory presets are being used. One of these four values, the output voltage, can be changed to a different monitor item. When an item other than the output voltage is to be monitored, set that value in user constant o1-01 (Monitor selection). Refer to the example procedure given later in this manual.

When the power is turned ON, the frequency reference will appear in the Unit's data display if the factor presets are being used. Any one of the four values monitored at startup (frequency reference, output frequency, output current, or the value set in user constant o1-01) can be selected to appear when the power is turned ON.

The value that appears at startup is determined by user constant o1-02 (Monitor selection after power up).

User constants o1-01 and o1-02 can be changed in the Basic or Advanced access levels. These user constants can be changed during operation.

■ Monitor Displays

The following notation is used in this manual when describing user constants.

User Constant Number	Display Name	Change during Operation	Setting Range	Unit	Factory Setting	Valid Access Levels	
						Open Loop Vector	Flux Vector
o1-01	Monitor selection		4 to 28	-	6	B	B

Use the last two digits from the *UI Monitor* list (UI-) to select a value. For example, the torque reference is UI-09, so input 9 to select the torque reference.

Change during Operation	Indicates whether or not the constant can be changed during operation.
	Can be changed during operation. Cannot be changed during operation.
Setting Range	The setting range for the constant.
Units	The unit used to set the constant ("-" indicates that no unit is used).
Factory Setting	The value preset at the factory. (There are different factory settings for each control method, i.e., if the control method is changed, the factory setting can also change.)
Valid Access Levels	Indicates the control methods and access levels under which the constant can be accessed and set.
	Q Accessible/settable under Quick-start.
	B Accessible/settable under Quick-start or Basic.
	A Accessible/settable under all access levels (Quick-start, Basic, and Advanced).
	Not accessible/settable in the specified control method.

User Constant Number	Name	Change during Operation	Setting Range	Unit	Factory Setting	Valid Access Levels	
						Open Loop Vector	Flux Vector
o1-02	Monitor selection after power up		1 to 4	-	1	B	B

Use constant o1-02 to indicate which value will be displayed when the Inverter is started. Refer to the following table.









Monitor Display Contents at Startup

Setting	Contents
1	Indicates the frequency reference at startup.
2	Indicates the output frequency at startup.
3	Indicates the output current at startup.
4	Indicates the value set in user constant o1-01 at startup.

◀EXAMPLE▶ Changing Monitor Display to Output Power at Startup in Basic Access Level

Change the access level to Basic if it is not already set there. Refer to *Figure 4.4* for the procedure to change from the Quick-start to Basic access level.

Use the following procedure to change the display from the output voltage to the output power.







Step	Key Sequence	Digital Operator Display	Remarks
1		MC5 Main Menu Operation	
2	 Press twice.	MC5 Main Menu Programming	
3		Function b1 Sequence	Changed to constant reading (function) level.
4	 Press twice.	Function o1 Monitor Select	
5		User Monitor Sel. Output Voltage	Changed to constant setting level.
6		o1-01 = 6 Output Voltage	
7	 Press twice.	o1-01 = 8 Output kWatts	
8		Entry Accepted	Writes-in the new setting.
		User Monitor Sel Output kWatts	After a few seconds, the Operator display is as shown on the left.

Output power has been set in place of output voltage.

www.repairtw.com

EXAMPLE Changing Monitor Display to Output Current at Startup in Basic Access Level

Use the following procedure to change user constant o1-02 so that the output current is displayed at startup. (The procedure continues from the end of the previous example.)

Step	Key Sequence	Digital Operator Display	Remarks
1	—	User Monitor Sel Output kWatts	Check the display.
2		Power-On Monitor Frequency Ref	
3		o1-02 = 1 Frequency Ref	
4	 Press twice.	o1-02 = 3 Output Current	
5		Entry Accepted	Writes-in the new setting.
		Power-On Monitor Output Current	After a few seconds, the Operator display is as shown on the left.
6		Function o1 Monitor Select	
7		MC5 Main Menu Programming	

Output current has been set in monitor selection after power ON.

4.2.5 Initialize Mode

The initialize mode is used to select the language displayed by the Unit, the access level, and the control method; it is also used to initialize the Unit's user constants. The structure of the initialize mode is shown in Figure 4.7.

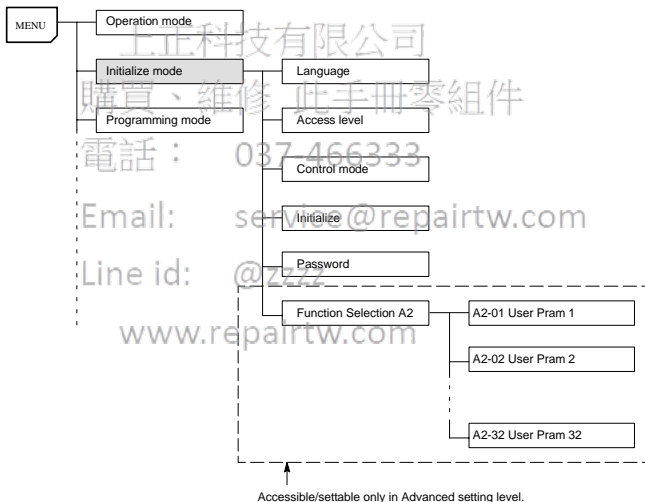

Fig 4.7 Structure of Initialize Mode User Constants







■ Selecting the Display Language: A1-00

- Use constant A1-00 to select the language displayed by the Inverter. A value of 0 sets English and a value of 1 sets Japanese.
- This user constant is not returned to the factory setting when constants are initialized. It must be manually reset to the factory setting.

User Constant Number	Name	Change during Operation	Setting Range	Unit	Factory Setting	Valid Access Levels	
						Open Loop Vector	Flux Vector
A1-00	Language selection for Digital Operator display		0 (English), 1 (Japanese)	-	1 (Japanese)	Q	Q

◀EXAMPLE▶ Changing the Language to English

Use the following procedure to change the display language from Japanese to English.

Step	Key Sequence	Digital Operator Display	Remarks
1		MC5	Changed to constant setting level.
2		MC5	
3		(Language) (Japanese)	
4		A1-00 = 1 (Japanese)	
5		A1-00 = 0 English	
6		Entry Accepted	
		Select Language English	After a few seconds, the Operator display is as shown on the left.

The display language has been set to English.

■ Setting the Access Level: A1-01

- Use constant A1-01 to select the user constant access level. This level determines which user constants can be changed and displayed.
- The user constants that can be displayed and changed also depend upon the control method being used.

User Constant Number	Name	Change during Operation	Setting Range	Unit	Factory Setting	Valid Access Levels	
						Open Loop Vector	Flux Vector
A1-01	Constant access level		0-4	-	2 Q	Q	Q

Access Level Settings

Setting	Function
0	Operation Only This setting allows the operation mode and initialize mode to be changed or displayed. Use this setting to prevent user constant settings from being changed.
1	User Program This setting allows only the user-selected constants (up to 32) to be changed or displayed. Select the desired user constants in A2-01 through A2-32.
2	Quick-start This setting allows the user constants required to start the Inverter (about 25) to be changed or displayed.
3	Basic This setting allows the commonly used user constants to be changed or displayed.
4	Advanced This setting allows all user constants to be changed or displayed.

■ Setting the Control Method: A1-02

- Use constant A1-02 to select one of the four control methods.
- This user constant is not returned to the factory setting when constants are initialized. It must be manually reset to the factory setting.
- When using winding change function, the setting of constants A1-02 and E3-01 (motor 2 control selection) should be the same.







User Constant Number	Name	Change during Operation	Setting Range	Unit	Factory Setting	Valid Access Levels	
						Open Loop Vector	Flux Vector
A1-02	Control method selection		2 3	-	2 (Open Loop Vector)	Q	Q

Control Method Settings

Setting	Function
2	Open-loop vector control (Vector control using the Inverter internal speed information).
3	Flux vector control (Vector control using a PG Speed Control Card).

◀EXAMPLE▶ Changing the Control Method to Flux Vector

Use the following procedure to change the control method to select flux vector.

Step	Key Sequence	Digital Operator Display	Remarks
1		MC5 Main Menu Operation	
2		MC5 Main Menu Initialize	
3		Select language English	
4		Control Method Open Loop	
5	Press twice. 	A1-02 = 2 Open Loop	Changed to constant setting level.
6		A1-02 = 3 Flux Vector	
7		Entry Accepted	Writes-in the new setting.
		Control Method Flux Vector	After a few seconds, the Operator display is as shown on the left.

The control method has been changed to flux vector.

Table 4.1 Control Method Characteristics

Characteristic	Open Loop Vector Control	Flux Vector Control
Basic Control Method	Current vector control without PG	Current vector control with PG
Speed Detector	Not required	Required (pulse generator)
Optional Speed Detectors	Not required	PG-B2 or PG-X2
Speed Control Accuracy	1:100	1:1000
Starting Torque	150%/1 Hz	150 %/0 r/min
Speed Control Range	0.2%	0.02%
Torque Limit	Possible	Possible
Torque Control	Not possible	Possible
Example Applications	<ul style="list-style-type: none"> • Variable speed drive applications. 	<ul style="list-style-type: none"> • Simple servo drives. • Precision speed control. • Torque control.

■ Initializing User Constants: A1-03

- Use constant A1-03 to initialize the user constants.
- When initialized, the user constants will return to their factory-preset values. You should normally record the setting of any constants that are changed from the factory presets.

User Constant Number	Name	Change during Operation	Setting Range	Unit	Factory Setting	Valid Access Levels	
						Open Loop Vector	Flux Vector
A1-03	Initialize		0, 1110, 2220, 3330	-	0	Q	Q

Settings to Initialize User Constants

Setting	Function
0	Returns to the Initialize Display without initializing any user constants.
1110	Initializes the user constants to the user settings.
2220	2-wire sequential initialization (Initializes the user constants to the factory settings.)
3330	3-wire sequential initialization

Initializing to User Settings

This function initializes the user constants to values that have been recorded as user settings.

To record the user settings, change the user constants to the desired values and then set user constant o2-03 (User constant initial value) to 1. Once user settings are recorded, the o2-03 value will be automatically reset to 0. (The 1110 function will be disabled when user constant o2-03 is set to 0.)

- Example of Wiring for 2-wire Sequential Operation

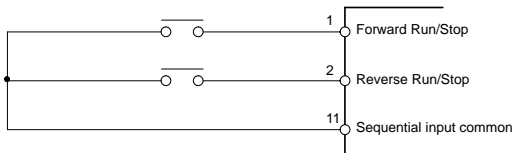

Fig 4.8 Example of Wiring for 2-wire Sequential Operation

- Example of Wiring for 3-wire Sequential Operation

The default settings of the multi-function inputs are different from the default settings of the 2-wire sequence. When setting a 3-wire sequence, the operation can be started and stopped with an automatically resetting pushbutton switch.

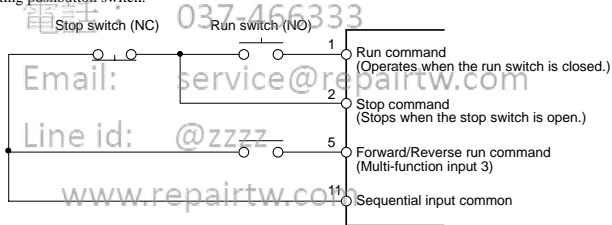

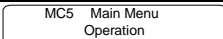

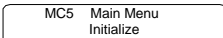

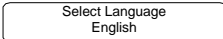

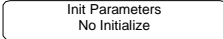

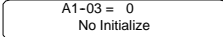

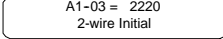

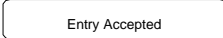
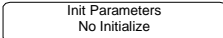

Fig 4.9 Example of Wiring for 3-wire Sequential Operation

◀EXAMPLE▶ Initializing for 2-wire Sequential Operation

Use the following procedure to initialize user constants to the factory settings.

Step	Key Sequence	Digital Operator Display	Remarks
1			
2			
3			
4	 Press 3 times.		
5			
6			
7		 	

The initialization has been completed for a 2-wire sequence.

上正科技有限公司

購買、維修 此手冊零組件

電話： 037-466333

Email: service@repairtw.com

Line id: @zzzz

www.repairtw.com

■ Passwords: A1-04 A1-05

- Use constants A1-04 and A1-05 to write-protect the initialize-mode user constants.
- User constants A1-01 through A1-03 and A2-01 through A2-32 can be displayed but not changed if the contents of A1-04 and A1-05 are not the same.
- To write-protect the initialize-mode user constants, set the password in A1-05 after inputting the desired values in A1-01 through A1-03 and A2-01 through A2-32. User constant A1-05 can be displayed by displaying A1-04 and pressing the Menu Key while pressing the Reset Key. (A1-05 can't be displayed with the usual Key sequences.)
- It will be possible to change the initialize-mode user constants again when the same password is written to A1-04 and A1-05.

User Constant Number	Name	Change during Operation	Setting Range	Unit	Factory Setting	Valid Access Levels	
						Open Loop Vector	Flux Vector
A1-04	Password 1		0 to 9999	-	0	Q	Q
A1-05	Password 2		0 to 9999	-	0	Q	Q

◀EXAMPLE▶ Setting the Password to 1000

Use the following procedure to set the password to 1000.

Step	Key Sequence	Digital Operator Display	Remarks
1		MC5 Main Menu Operation	
2		MC5 Main Menu Initialize	
3		Select Language English	
4		Enter Password A1-04 = 0	
5	Press 4 times. 	Select Password A1-05 = 0	
	Hold RESET.		
	And press MENU.		
6		Select Password 0000	The first digit will blink. The blinking digit can be changed.
7		Select Password 1000	The value of the digit will increment each time the Increment Key is pressed and then stop at 9. Press the Decrement Key to decrease the value.
8		Entry Accepted	Writes-in the new setting.
		Select Password A1-05 = 1000	After a few seconds, the Operator display is as shown on the left.
9		Enter Password A1-04 = 0	

The password has been set to 1000.

To enable changing user constants, set the same password in A1-05 = 0.

■ Setting User Constants: A2-01 to A2-32

- User constants A2-01 through A2-32 specify the constants that can be displayed and changed when the access level (A1-01) is set to 1 (user programs).
- User constants A2-01 through A2-32 can be changed only in the Advanced access level and cannot be changed during operation.
- The following restrictions apply to setting/displaying user constants when the access level is set to the user program access level.

Operation	The Quick-start level user constants can be displayed.
Initialize	The Quick-start level user constants can be displayed or set.
Programming	Only the user constants specified in A2-01 through A2-32 can be displayed or set.
Autotuning	The user constants cannot be displayed.
Modified constants	The user constants cannot be displayed.

EXAMPLE Setting C1-08 (Deceleration Time 4) in A2-01 to Define it as a User Constant

Step	Key Sequence	Digital Operator Display	Remarks
1		MC5 Main Menu Operation	
2		MC5 Main Menu Initialize	
3		Select Language English	
4		Function A2 User Constants	
5		User Param 1 A2-01 = ----	
6		User Param 1 -----	The first digit blinks.
7		User Param 1 C1-01 /1/	
8	Press twice. 	User Param 1 C1-01 /1/1/	Writes-in set value 0000.
9	Press twice. 	User Param 1 C1-08 /1/1/	
10	Press 7 times. 	Entry Accepted	Writes-in the new setting.
11		User Param 1 A2-01 = C1-08	After a few seconds, the Operator display is as shown on the left.
11		Function A2 User Constants	
12		Access Level Advanced	
13	Press twice. 	A1-01 = 4 Advanced	
14		A1-01 = 1 User Program	The user program access level can be set only after one or more constants are set as user constants in A2-01 to A2-32. If no constants are set, the user program access level will not be displayed for A1-01.
15	Press twice. 	Entry Accepted	Writes-in the new setting.
15		A1-01 = 4 Advanced	(If the DATA/ENTER Key is not pressed within one minute, the Operator display will return as shown on the left. In this case, repeat from step 14.)
16		Access Level User Program	After a few seconds, the Operator display is as shown on the left.
16		MC5 Main Menu Initialize	

The access level has been set to the user program access level.

Figure 4.10 shows the structure of the user constants.

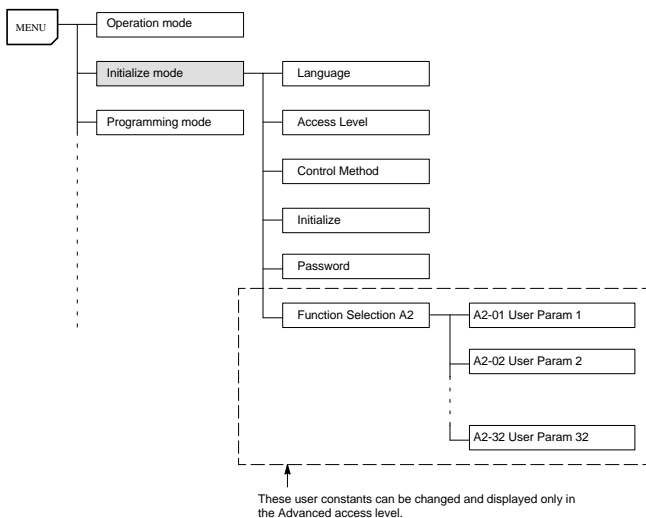

Fig 4.10 Structure of User Constants

上正科技有限公司
 購買、維修 此手冊零組件
 電話： 037-466333
 Email: service@repairtw.com
 Line id: @zzzz
 www.repairtw.com

4.2.6 Programming Mode

The Inverter user constants can be set in programming mode. The user constants which can be changed and displayed depend on the access level and control method that are being used. Refer to the following table to determine if a user constant can be changed.

The groups of constants in programming mode and their functions are shown in *Table 4.5*.

Table 4.5 Programming Mode Constant Groups

Group	Function	Display	Comments	Control Method		
				Over Loop Vector	Flux Vector	
b	Application	b1 Operating modes	Sequence	Settings such as the reference input method		
		b2 DC braking	DC Braking	DC braking function settings		
		b3 Speed searching	Speed Search	Speed search function settings		
C	Tuning	C1 Acceleration/deceleration times	Accel/Decel	Acceleration/deceleration time settings		
		C2 S-curve acceleration/deceleration	S-Curve Acc/Dec	S-curve characteristics for accel/decel times		
		C3 Slip compensation	Motor-Slip Comp	Slip compensation function settings		
		C4 Torque compensation	Torque Comp	Torque compensation function settings		
		C5 Speed control	ASR Tuning	Speed control loop user constant settings		
		C6 Carrier frequencies	Carrier Freq	Carrier frequency settings		
		C8 Factory tuning constants	Factory Tuning	Adjustment for open-loop vector control		
		d	Reference	d1 Frequency references	Preset Reference	Operator frequency reference settings
d2 Frequency upper/lower limits	Reference Limits			Frequency upper and lower limit settings		
d3 Jump frequencies	Jump Frequencies			Prohibited frequency settings		
E	Motor	E1 V/f characteristics	V/f Pattern	Sets the motor V/f characteristics.		
		E2 Motor constants	Motor Setup	Sets the motor constants.		
		E3 Motor 2 control method	Motor 2 Ctl Meth	Sets the control methods for motor 2.		
		E4 V/f Characteristics 2	V/F pattern 2	Sets the V/f characteristics for motor 2.		
		E5 Motor 2 constants	Motor 2 Setup	Sets the motor constants for motor 2.		
F	Options	F1 PG speed control card settings	PG Option Setup	User constant settings for a PG Card		
		F2 Analog Reference Card AI	AI-14 Setup	User constant settings for an Analog Reference Card		
		F3 Digital Reference Card DI	DI-08, 16 Setup	User constant settings for a Digital Reference Card		
		F4 Analog Monitor Card AO	AO-08, 12 Setup	User constant settings for an Analog Monitor Card		
		F5 Digital Output Card DO	DO-02C	User constant settings for a Digital Output Card		
		F6 Digital Output Card DO	DO-08	User constant settings for a Digital Output Card		
		F7 Pulse Monitor Card PO	PO-36F Setup	User constant settings for a Pulse Monitor Card		
		F8 SI-F/SI-G Transmission Card	SI-F/G	User constant settings for a Transmission Card		
		F9 CP-916B Transmission Card	DDS/SI-B	User constant settings for a Transmission Card		

Group	Function	Display	Comments	Control Method		
				Over Loop Vector	Flux Vector	
H Terminal	H1	Multi-function inputs	Digital Inputs	Function selection for multi-function inputs		
	H2	Multi-function outputs	Digital Outputs	Function selection for multi-function outputs		
	H3	Analog inputs	Analog Inputs	Function selection for analog inputs		
	H4	Multi-function analog outputs	Analog Outputs	Function selection for analog outputs		
	H5	MEMOBUS communications	Serial Com Setup	MEMOBUS communications settings		
L Protection	L1	Motor protection functions	Motor Overload	Overload protection settings and selection		
	L2	Momentary power loss ride-through	PwrLoss Ride-thru	Selects the power-loss processing method.		
	L3	Stall prevention	Stall Prevention	Stall prevention settings and selection		
	L4	Frequency detection	Ref Detection	Frequency detection settings and selection		
	L5	Fault restart	Fault Restart	Fault restart function settings		
	L6	Overtorque detection	Torque Detection	Overtorque detection settings and selection		
	L7	Torque limits	Torque Limit	Torque limit settings (vector control only)		
	L8	Hardware protection	Hdwe Protection	Overheating and phase loss protection settings		
o Operator	o1	Display/Monitor settings	Monitor Select	Selects the display and setting methods.		
	o2	Function settings	Key Selections	Key function selection and other user constants		

上正科技有限公司

購買、維修 此手冊零組件

電話： 037-466333

Email: service@repairtw.com

Line id: @zzzz

www.repairtw.com

Figure 4.11 shows the difference in the display structure for the various access levels.

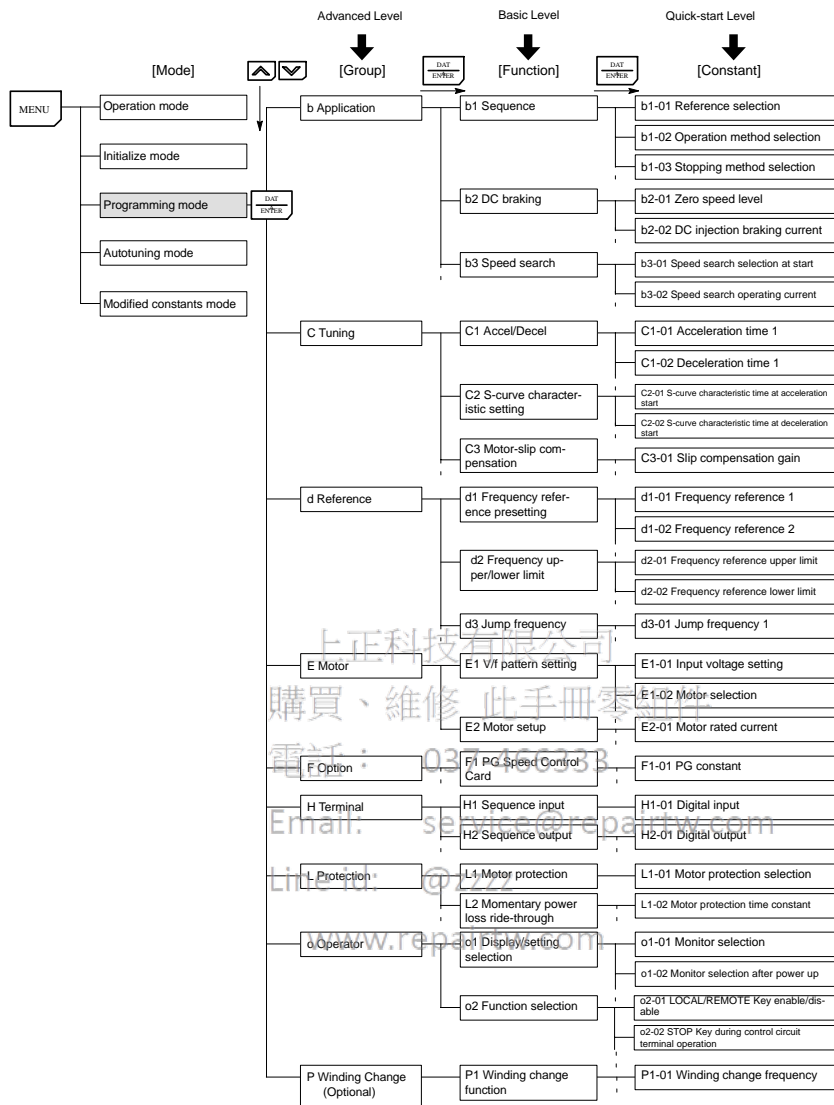

Fig 4.11 Display Structures for Different Access Levels

4.2.7 Autotuning Mode



CAUTION

- Disconnect the load (machine, device) from the motor before autotuning.
The motor may turn, possibly resulting in injury or damage to equipment. Also, motor constants cannot be correctly set with the motor attached to a load.

Autotuning automatically tunes and sets the required motor constants when operating in the open-loop or flux vector control modes. Always perform autotuning before starting operation.

When the rated voltage, rated current, rated frequency, and number of poles listed on the motor nameplate have been input and the RUN Key is pressed, the motor constants calculated from these values will be written to E1-04 through E2-09 automatically.







When motor cannot be disconnected from the load, motor constants can be set by calculation. Contact your YASKAWA representatives for details.

The Inverter's autotuning function automatically determines the motor constants, while a servo system's autotuning function determines the size of a load, so these autotuning functions are fundamentally different.

EXAMPLE Autotuning Procedure

Step	Key Sequence	Digital Operator Display	Remarks
1		MC5 Main Menu Operation	
2	 press 3 times.	MC5 Main Menu Autotuning	
3		Rated Voltage (see note) 200.0 VAC	
4		Rated Voltage 200.0 VAC 11	The leading digit blinks. When Increment Key is pressed, blinking value increases. When Decrement Key is pressed, blinking value decreases.
5		Rated Voltage 200.0 VAC 11	The digit to be set moves to the right and blinks. Follow the above procedures as outlined in step 4.
6		Entry Accepted	After selecting values for steps 4 and 5, press DATA/ENTER Key. The Operator display is as shown on the left. The value is written-in.
7		Rated Voltage 200.0 VAC	After a few seconds, the Operator display is as shown on the left.
8		Rated Current 1.90 A	Press the keys as in steps 4, 5, 6 of rated voltage setting.
9		Rated Frequency 60.0 HZ	
10		Rated Frequency 60.0 HZ	Press the keys as in steps 4, 5, 6 of rated voltage setting.
11		Rated Speed 1750 RPM	
12		Rated Speed 1750 RPM	Press the keys as in steps 4, 5, 6 of rated voltage setting.

Note Rated voltage for vector control motors is approx. 10 to 20% lower than general-purpose motors. Verify motor voltage listed on the nameplate or the test report before use.

Step	Key Sequence	Digital Operator Display	Remarks
13		Number of Poles 4	
14			Press the keys as in steps 4, 5, 6 of rated voltage setting.
15		Select Motor 1/2 1	
16			Press the keys as in steps 4, 5, 6 of rated voltage setting. Leave the setting at 1 to set the value for motor 1 (the motor contacts normally used.) Select "2" to store the autotuning results for motor 2.
17		Tuning Ready? Press RUN Key	
18		Tune Processing Hz	Autotuning starts and the motor rotates for approx. one minute. Then the motor stops automatically.
		Tune Successful	
19		MC5 Main Menu Operation	

Returns to the operation mode display.

IMPORTANT

If a fault occurs during autotuning, refer to *Table NO TAG Troubleshooting Autotuning Faults*.

上正科技有限公司

購買、維修 此手冊零組件

電話： 037-466333

Email: service@repairtw.com

Line id: @zzzz

www.repairtw.com

4.2.8 Modified Constants Mode











The modified constants mode is used to change or display user constants that have been changed from their factory-preset values.

When any user constants have been changed in programming mode (b1-01 through o2-08), press the DATA/ENTER Key in modified constants mode to display these user constants. (The initialize mode user constants won't be displayed.)

◀EXAMPLE▶ Changing Frequency Reference 1 to 30.00 in Modified Constants Mode

In the following example, user constants C1-01 (Acceleration time 1) and d1-01 (Frequency reference 1) have been changed from their factory settings.

The settings for these two user constants are displayed, and the setting for d1-01 is changed from 60.00 Hz to 30.00 Hz while C1-01 is set to 20.0 seconds.

Step	Key Sequence	Digital Operator Display	Remarks
1		MCS Main Menu Operation	
2		MCS Main Menu Modified Consts	
3		Accel Time 1 C1-01 = 20.0 Sec	
4		Frequency Ref 1 d1-01 = 60.00 HZ	
5		Frequency Ref 1 060.00 HZ	
6		Frequency Ref 1 060.00 HZ	Blinking digit moves 1 place to the right.
7	 press 3 times.	Frequency Ref 1 030.00HZ	
8		Entry Accepted	30.00 Hz is written-in.
9		Frequency Ref 1 d1-01 = 30.00 HZ	After a few seconds, the Operator display is as shown on the left.
10		MCS Main Menu Modified Consts	Preset reference 1 is changed to 30.00 Hz in the modified constants mode.
		MCS Main Menu Operation	

Returns to the operation mode display

Email: service@repairtw.com

Line id: @zzzz

www.repairtw.com

5

Trial Operation

This chapter describes the preparations and Digital Operator procedures for trial operation of the VS-626MC5 and provides an example of trial operation.

5.1 Procedure	5 - 3
5.2 Trial Operation Procedures	5 - 4
5.2.1 Power ON	5 - 4
5.2.2 Checking the Display Status	5 - 4
5.2.3 Initializing Constants	5 - 4
5.2.4 Setting Input Voltage	5 - 5
5.2.5 Autotuning	5 - 6
5.2.6 No-load Operation	5 - 8
5.2.7 Loaded Operation	5 - 9

購買、維修 此手冊零組件

電話： 037-466333

Email: service@repairtw.com

Line id: @zzzz

www.repairtw.com



WARNING

- Check to be sure that the front cover is attached before turning ON the power supply. Do not remove the front cover during operation.
An electric shock may occur.
- Do not come close to the machine when the fault reset function is used. If the alarmed is cleared, the machine may start moving suddenly. Also, design the machine so that human safety is ensured even when it is restarted.
Injury may occur.
- Provide a separate emergency stop switch; the Digital Operator's STOP Key is valid only when its function is set.
Injury may occur.
- Reset alarms only after confirming that the RUN signal is OFF. If an alarm is reset with the RUN signal turned ON, the machine may suddenly start.
Injury may occur.



CAUTION

- Don't touch the radiation fins (heat sink), braking resistor, or Braking Resistor Unit. These can become very hot.
Otherwise, a burn injury may occur.
- Be sure that the motor and machine is within the applicable ranges before starting operation.
Otherwise, an injury may occur.
- Provide a separate holding brake if necessary.
Otherwise, an injury may occur.
- Don't check signals while the Inverter is running.
Otherwise, the equipment may be damaged.
- Be careful when changing Inverter settings. The Inverter is factory set to suitable settings.
Otherwise, the equipment may be damaged. You must, however, you must set the power supply voltage jumper for 400 V class Inverters of 18.5 kW or higher (see 5.2.4).

5

上正科技有限公司

購買、維修 此手冊零組件

電話： 037-466333

Email: service@repairtw.com

Line id: @zzzz

www.repairtw.com

5.1 Procedure

Perform trial operation according to the following operational flow.

Item	Contents	Page
Installation and Mounting ↓	Install the Inverter according to the installation conditions. <ul style="list-style-type: none"> Ensure that the installation conditions are met. 	- 1
Wiring and Connection ↓	Connect to the power supply and peripheral devices. <ul style="list-style-type: none"> Select peripheral devices which meet the specifications and wire correctly. 	- 1
Power ON ↓	Carrying out the following pre-connection checks before turning ON the power supply: <ul style="list-style-type: none"> Always ensure that a power supply of the correct voltage is used and that the power input terminals (R, S, T) are wired correctly. 200 V class: 3-phase 200 to 230 VDC, 50/60 Hz 400 V class: 3-phase 380 to 460 VDC, 50/60 Hz Make sure that the Motor output terminals (U, V, W) and the Motor are connected correctly. Make sure that the control circuit terminals and the control device are wired correctly. Make sure that all control circuit terminals are turned OFF. When using a PG Speed Control Card, ensure that it is wired correctly. Set the motor to no-load status, (not connected to the mechanical system). Having conducted the above checks, connect the power supply.	- 4
Check the Display Status ↓ 1	Check to be sure that there are no faults in the Inverter. <ul style="list-style-type: none"> If the display at the time the power is connected is normal, it will read as follows: Data Display: Frequency Ref When an fault has occurred, the details of the fault will be displayed. In that case, refer to <i>Section 9 Maintenance Operations</i>. 	- 4
Setting the Input Voltage ↓	Set the Inverter input voltage (E1-01) to the correct voltage.	- 5
Set the Motor ↓	Set the proper motor protection (E1-02).	- 6
Autotuning ↓ 2	Execute autotuning for motor unit separately before open-loop vector control or Flux vector control operation.. <ul style="list-style-type: none"> When autotuning is executed, motor constants are set automatically. 	- 6
No-load Operation ↓	Start the no-load motor using the Digital Operator. <ul style="list-style-type: none"> Set the frequency reference using the Digital Operator and start the motor using key sequences. 	- 8
Actual Load Operation ↓	Connect the mechanical system and operate using the Digital Operator. <ul style="list-style-type: none"> When there are no difficulties using the no-load operation, connect the mechanical system to the motor and operate using the Digital Operator. 	- 9
Operation	Basic Operation: Operation based on the basic settings required to start and stop the Inverter. Advanced Operation: Operation which uses advanced functions. <ul style="list-style-type: none"> For operation within standard constants select "Basic Operation." To use the various applied functions such as, direct current control braking, speed search, S-curve acceleration/ deceleration, slip compensation, torque compensation, and select "Advanced Operation" in combination with "Basic Operation." 	NO TAG NO TAG

* 1. It is sometimes necessary to initialize constants after checking the display status.

Initializing Constants	Initialize the constants. <ul style="list-style-type: none"> Check the Inverter capacity setting (kVA) in o2-04 before replacing the controller PCB with a spare. 	- 4
------------------------	---	-----

* 2. When motor cannot be disconnected from the load, motor constants can be set by calculations. Contact your YASKAWA representatives for details.

5.2 Trial Operation Procedures

5.2.1 Power ON

■ Checkpoints before Turning ON the Power Supply

- Check that the power supply is of the correct voltage.
200 V class: 3-phase 200 to 230 VDC, 50/60 Hz
400 V class: 3-phase 380 to 460 VDC, 50/60 Hz
- Make sure that the motor output terminals (U, V, W) and the motor are connected correctly.
- Make sure that the Inverter control circuit terminal and the control device are wired correctly.
- Set all Inverter control circuit terminals to OFF.
- When using a PG Speed Control Card, make sure that it is wired correctly.
- Make sure that the motor is not connected to the mechanical system (no-load status)

5.2.2 Checking the Display Status

If the Digital Operator's display at the time the power is connected is normal, it will read as follows:

Normal

Frequency Ref
U1-01 = 0.00 HZ

The frequency reference monitor is displayed in the data display section.

When an fault has occurred, the details of the fault will be displayed instead of the above display. In that case, refer to *Section NO TAG Maintenance Operations*. The following display is an example of a fault display.

Fault

UV
Under Voltage

The display will differ depending on the type of fault.

5.2.3 Initializing Constants

- When replacing the controller PCB, check the Inverter capacity (kVA) in o2-04 first and then initialize constants to the factory settings. There is no need to initialize constants the first time trial operation is performed after purchasing the Inverter.
- To initialize the constants, set "2220" in A1-03 (Initialize).
- After initialization, the access level is set to Quick-start (A1-01). The following table shows the setting method for Quick-start.

Use the following procedure to initialize constants.

Step	Key Sequence	Digital Operator Display	Remarks
		Frequency Ref U1-01 = 0.00 HZ	
1	MENU	MC5 Main Menu Operation	Displays operation mode.
2	▲	MC5 Main Menu Initialize	Displays initialize mode.
3	DATA ENTER	Select Language English	Puts the Inverter in initialize mode.
4	▲	Initialize Select	Displays the Initialize display.
5	DATA ENTER	A1-03 = 0 Select	Displays the constant setting for A1-03.
6	▲	A1-03 = 2220 2-wire Initial	Initializes for a 2-wire sequence.
7	DATA ENTER	Entry Accepted	Writes the set values. "Entry Accepted" is displayed for approximately 0.5 seconds.
		Initialize Select	Returns to the Initialize display.
8	ESC	MC5 Main Menu Initialize	Returns to the initialize mode display.

5.2.4 Setting Input Voltage

Set the input voltage of the Inverter (E1-01) according to the power supply voltage.









■ Input Voltage: E1-01

Set the input voltage.

User Constant Number	Name	Change during Operation	Setting Range	Unit	Factory Setting	Valid Access Levels	
						Open Loop Vector	Flux Vector
E1-01	Input voltage setting		155 to 255 (310 to 510)*	VAC	200 (400)*	Q	Q

* Values in parentheses are for 400 V class Inverters.

Use the following procedure to set a 200 V class Inverter to an input voltage of 230 V.

Step	Key Sequence	Digital Operator Display	Remarks
1		Main Menu Initialize	Displays initialize mode.
		Main Menu Programming	Displays programming mode.
2		Frequency Ref Terminal	Puts the Unit in programming mode.
3		Input Voltage E1-01 = 200 VAC	Displays the input voltage setting display.
4		Input Voltage 200 VAC 	The leading digit will blink
5		Input Voltage 200 VAC 	The 2nd digit will blink.
6		Input Voltage 230 VAC 	Set to "3"
7		Entry Accepted	The set value is overwritten. "Entry Accepted" is displayed for approximately 0.5 seconds.
8		Input Voltage E1-01 = 230 VAC	Returns to the input voltage display. Check that the data has been updated.
		Main Menu Programming	Returns to the programming mode display.

■ Setting the Power Supply Voltage Jumper (400 V Class Inverters of 18.5 kW or Higher)

Set the power supply voltage jumper after setting the input voltage constant (E1-01) for 400 V class Inverters of 18.5 kW or higher. Insert the jumper into the voltage connector nearest to the actual power supply voltage.

The jumper is factory-set to 440 V when shipped. If the power supply voltage is not 440 V, use the following procedure to change the setting.

1. Turn OFF the power supply switch and wait for at least one minute (three minutes for models larger than 30 kW) before removing the front panel and setting the jumper.
2. Remove the front cover.
3. Insert the jumper at the position for the voltage supplied to the Inverter (see Figure 5.1).

4. Replace the front cover.

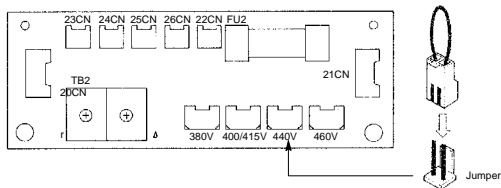

Fig 5.1 Setting the Power Supply Voltage (Illustration Above is for 400 V Class Inverter between 18.5 kW and 45 kW)

■ **Motor Selection (Motor Overheating Protection): E1-02**

Set the type of motor being used with the motor selection constant (E1-02). This setting is a reference for the motor overheat protection.

User Constant Number	Name	Change during Operation	Setting Range	Unit	Factory Setting	Valid Access Levels	
						Open Loop Vector	Flux Vector
E1-02	Motor selection (motor overheating protection)		0 to 2	-	0	Q	Q

● E1-02 Settings

Setting	Function
0	Standard motor (general-purpose motor)
1	Special motor (inverter-exclusive motor)
2	Special motor (vector-exclusive motor)

5.2.5 Autotuning

■ **Autotuning Operation**

Use the following procedure to autotune the motor constants, i.e., set them automatically.

Step	Key Sequence	Digital Operator Display	Remarks
1		MC5 Main Menu Programming	Displays programming mode.
1		MC5 Main Menu Auto-Tuning	Displays autotuning mode.
2		Rated Voltage *1 200.0 VAC	Displays the rated voltage.*2
3		Rated Current *1 1.90 A	Displays the rated current.*2
4		Rated Frequency *1 60.0 HZ	Displays the rated frequency.*2
5		Rated Speed *1 1750 RPM	Displays the rated speed.*2
6		Number of Poles *1 4	Displays the number of poles.*2
7		Select Motor 1/2 1	Displays the motor selection. (Leave set at "1" for motor 1 (the normally used motor constants).)
8		Tuning Ready ? Press RUN key	Displays a confirmation prompt for the start of the autotuning function. (The lower line will blink.)
9		Tune Proceeding 'HZ' 'A'	Starts the autotuning function. (The upper line will blink.)

Step	Key Sequence	Digital Operator Display	Remarks
10			Indicates the completion of autotuning.
			Returns to the operation mode display.

* 1. When the values displayed and the motor rated values differ, set each value separately.

* 2. There are differences between simple and advanced settings. Refer to the table below.

Operator Display	Simple Setting (Motor nameplate)	Advanced Setting
Rated Voltage	Motor rated voltage	No-load voltage at rated revolutions
Rated Frequency	Motor rated frequency	No-load frequency at rated revolutions

Rated voltage for vector control motors is approx. 10 to 20% lower than general-purpose motors. Always verify motor voltage listed on the nameplate or test report before use.

The following example procedure changes the motor rated current to 1.60 A.

Step	Key Sequence	Digital Operator Display	Remarks
1			Displays the rated current.
			When changing the set values, press the DATA/ENTER Key and the digit to change will blink.
2			Select the digit to be changed.
3			Set to 001.60 A.
4			Press the DATA/ENTER Key to overwrite the set values. "Entry Accepted" will be displayed for approximately 0.5 seconds.
			Returns to the rated current display.

- When autotuning has been executed correctly, the constants (E1-04 to E2-09) will be automatically written.
- Use the following troubleshooting procedure if a fault occurs during autotuning.

■ Troubleshooting Autotuning Faults

The displays and countermeasures for autotuning faults are shown below in Table 5.1. If one of these faults is detected, it will be displayed on the Operator and the motor will coast to a stop. The fault contact and alarm contact outputs will not function. When a fault occurs, "Tune Aborted" will be displayed and the messages shown in the following table will blink.

Table 5.1 Troubleshooting Autotuning Faults

Display Message	Fault	Description	Countermeasure
Data Invalid	Motor data fault	Motor data error for autotuning. Autotuning was not completed within a set time.	• Check the input data. • Check the Inverter and motor capacities.
Resistance	Line resistance fault		
No-load Current	No-load current fault		
Saturation -1	Saturated core coefficient 1 fault		
Saturation -2	Saturated core coefficient 2 fault		
Rated Slip	Rated slip fault		
Accelerate	Acceleration fault	The motor did not accelerate within a set time.	• Increase the acceleration time (C1-01). • Increase the torque limits (L7-01, -02) if these have been decreased. • Disconnect the motor from the machine if it has been connected.

Display Message	Fault	Description	Countermeasure
PG Direction	Motor direction fault	There is a contact fault between the Inverter, PG (phase A and B), and motor (phases U, V, and W)	<ul style="list-style-type: none"> Check the PG wiring. Check the motor wiring. Check the PG direction and constant F1-05.
Motor speed	Motor speed fault	The torque reference was too large (100%) during autotuning.	<ul style="list-style-type: none"> Disconnect the motor from the machine if it has been connected. Increase the acceleration time (C1-01). Check the input data (particularly the number of PG pulses).
ALARM: Over Load (Displayed after completion of autotuning)	Tuning overload fault	The torque reference was over 20% during autotuning.	Check the input data (particularly the number of PG pulses) if the motor is being autotuned separately.
Tune Aborted Minor Fault:	Minor fault	A minor Inverter fault occurred.	Check the minor fault indicated in the boxes in the display shown at the left.
Tune Aborted V/f Over Setting (Displayed after completion of autotuning)	V/f Over Setting	Torque reference exceeded 100%, and no-load current exceeded 70%.	<ul style="list-style-type: none"> Check the setting. Disconnect the motor from the load.

- Fault displays can be cleared by pressing the MENU Key.
- All set constants (motor constants) will be initialized if a fault occurs. Reset the constants from the beginning when before starting autotuning again.







5.2.6 No-load Operation

The section describes trial operation in which the motor is operated from the Digital Operator with the motor in the no-load state (with the motor not connected to the mechanical system).

■ Setting the Frequency Reference

Set the frequency reference on the frequency reference monitor in the operation mode.

The following is an operation example with the frequency reference set to 10 Hz.

Step	Key Sequence	Digital Operator Display	Remarks
1		MC5 Main Menu Operation	Displays operation mode.
2		Frequency Ref U1-01 = 0.00 HZ	Puts the Unit in operation mode and displays the frequency reference.
3		Frequency Ref U1-01 = 0.00 HZ	Switches operation to the Digital Operator. (SEQ, REF and LED indicators turn OFF.)
4		Frequency Ref 000.00 HZ	Sets the frequency reference.
5		Frequency Ref 000.00 HZ	The tens digit blinks.
6		Frequency Ref 010.00 HZ	Set to 010.00 Hz.
		Entry Accepted	The set values are overwritten.
		Frequency Ref 010.00 HZ	Returns to the frequency reference display.

■ Operation Using the Digital Operator

- Press the RUN Key. The motor will start to rotate. (forward rotation)
- Press the FWD/REV Key. The motor will rotate in the reverse direction.
- Press the Stop Key. The motor will stop. (The RUN Key indicator will keep blinking until the motor stops.)
- The frequency reference can be changed, even during operation. When this is done, the frequency reference is changed as soon as the DATA/ENTER Key is pressed to input the set values.
- If the Jog Key is pressed when the Inverter is stopped, it will rotate by the jog frequency (Factory setting: 6.0 Hz) only while the Key is being pressed.

■ Checking the Operating Status

- After changing the frequency reference or the rotation direction, check that there is no oscillation or abnormal sound from the motor.
- Check that no faults have occurred in the Inverter during operation.

5.2.7 Loaded Operation

After checking the operation with the motor in no-load status as described in 5.2.6, connect the load mechanical system and perform trial operation with an actual load.

■ Connecting the Load System

- After confirming that the motor has stopped completely, connect the mechanical system.
- Be sure to tighten all the screws when securing the motor shaft to the mechanical system.

■ Operation using the Digital Operator

- Use the Digital Operator in the same way as in no-load operation.
- If fault occurs during operation, make sure the STOP Key on the Digital Operator is easily accessible.
- At first, set the frequency reference to a low speed of one tenth the normal operating speed.

■ Checking Operating Status

- Having checked that the operating direction is correct and that the machine is operating smoothly at slow speed, increase the frequency reference.
- After changing the frequency reference or the rotation direction, check that there is no oscillation or abnormal sound from the motor. Check the monitor display to ensure that the U1-03 (output current) is not excessive.

■ Adjusting AFR Gain

There are some guidelines to settle the motor vibrations or fluctuations when carrying a load.

- Gradually increase the AFR gain (C8-08) while checking the motor response. If the motor still fluctuates or vibrates although C8-08 is set to 2.0, gradually increase the AFR time constant (C8-09) to 100 ms.
- Increasing the torque compensation time constant (C4-02) may settle the motor vibrations. Changing constants C8-08, C8-09 and C4-02 may slow the speed and torque responses.

電話： 037-466333

Email: service@repairtw.com

Line id: @zzzz

www.repairtw.com

6

Basic Operation

This chapter explains the basic settings required to operate and stop the VS-626MC5. The user constants described here will be sufficient for simple Inverter.

Even when your application requires special functions, such as torque control or PID control, make these basic settings first and then go to the explanations of those special functions in chapter *NO TAG Advanced Operation*.

6.1	Common Settings	6 - 2
6.1.1	Setting the Access Level and Control Method: A1-01, A1-02	6 - 2
6.1.2	Frequency Reference Settings: b1-01, H3-01, H3-08, H3-09	6 - 4
6.1.3	Frequency Reference from Digital Operator: b1-01, o1-03, d1-01 to d1-09	6 - 7
6.1.4	Run Source and Sequence Input Responsiveness: b1-02, b1-06, b1-07	6 - 9
6.1.5	Acceleration/Deceleration Times: C1-01 through C1-08, C1-09, C1-10, C1-11	6 - 10
6.1.6	Prohibiting Reverse Operation: b1-04	6 - 11
6.1.7	Selecting the Stopping Method: b1-03	6 - 12
6.1.8	Multi-function Input Settings: H1-01 through H1-06	6 - 12
6.2	Open-loop Vector Control	6 - 17
6.2.1	Autotuning for general-purpose motors	6 - 17
6.2.2	Autotuning for machine tool spindle motors	6 - 18
6.2.3	Autotuning Faults	6 - 21
6.3	Flux Vector Control	6 - 22
6.3.1	PG Speed Control Card Settings	6 - 22
6.3.2	Setting the Zero-speed Operation Constants	6 - 25
6.3.3	Autotuning for general-purpose motors	6 - 27
6.3.4	Autotuning for machine tool spindle motors	6 - 29
6.3.5	Autotuning Faults	6 - 31
6.3.6	Speed Control (ASR) Structure	6 - 32
6.3.7	Speed Control (ASR) Gain	6 - 34

6

上正信
購買
電話
Email: service@repairtw.com
Line id: 6222
www.repairtw.com

6.1 Common Settings

This section describes the constants that are used with all of the control methods.

6.1.1 Setting the Access Level and Control Method: A1-01, A1-02

■ Constant Access Level: A1-01

- Select the constant access level. This level determines which constants can be accessed and changed.

User Constant Number	Name	Change during Operation	Setting Range	Unit	Factory Setting	Valid Access Levels	
						Open Loop Vector	Flux Vector
A1-01	Constant access level		0 to 4	-	2 (Q)	Q	Q







- Access Level Settings

Setting	Name	Function
0	Operation Only	Allows the operation mode and initialize mode to be displayed or changed. Use this setting to prevent constant settings from being changed.
1	User Program	Allows only the user-selected constants (up to 32) to be displayed or changed. Set the desired constants as "User Parameters" in constants A2-01 through A2-32.
2	Quick-Start	Allows the constants required to start the Inverter (about 25) to be displayed or changed.
3	Basic	Allows the commonly used constants to be displayed or changed.
4	Advanced	Allows all constants to be displayed or changed.

- The control method setting also affects which constants can be displayed and changed. Refer to chapter *NO TAG User Constant Lists*.
- The constants required for basic operation can be displayed and changed in the Basic level, but this section also describes constants that can be set only in the Advanced level, so set the access level to Advanced.

Changing the Access Level

The following procedure shows how to change from Quick-Start to Advanced.

Step	Key Sequence	Digital Operator Display	Remarks
1		MC5 Main Menu Operation	Displays operation mode.
2		MC5 Main Menu Initialize	Displays initialize mode.
3		Select Language English	Puts the Unit in initialize mode. (Select Language display)
4		Access Level Quick-Start	Displays the Access Level (A1-01).
5		A1-01 = 2 Quick-Start	Displays the constant setting for A1-01.
6		A1-01 = 4 Advanced	Displays Advanced.
7	Depress twice 	Entry Accepted	Writes the new setting.
		Access Level Advanced	Returns to the Access Level display.

■ Control Method: A1-02

- Select one of the four control methods.
- This constant is not initialized by the initialize operation.

User Constant Number	Name	Change during Operation	Setting Range	Unit	Factory Setting	Valid Access Levels	
						Open Loop Vector	Flux Vector
A1-02	Control method selection		2 3	-	2 Open Loop Vector	Q	Q

• Control Method Settings

Setting	Control Method	Function
2	Open loop vector control	Vector control using the Inverter's internal speed information
3	Flux vector control	Vector control using a PG Speed Control Card

- The characteristics of each control method are shown in *Table 6.1*.

Table 6.1 Control Method Characteristics

Characteristic	Open Loop Vector	Flux Vector
Basic control method	Current vector control without PG	Current vector control with PG
Speed detector	Not required	Required (pulse generator)
Optional speed detectors	Not required	PG-B2 or PG-X2
Speed control range	1:100	1:1000
Starting torque	150%/1 Hz	150%/0 r/min
Speed control accuracy	0.2%	0.02%
Torque limit	Possible	Possible
Example applications	<ul style="list-style-type: none"> • Variable speed drive applications. 	<ul style="list-style-type: none"> • Simple servo drives. • Precision speed control.

上正科技有限公司

購買、維修 此手冊零組件

電話： 037-466333

Email: service@repairtw.com

Line id: @zzzz

www.repairtw.com

6.1.2 Frequency Reference Settings: b1-01, H3-01, H3-08, H3-09

These settings are required when inputting analog voltage or current signals from the control circuit terminals.

■ Frequency Reference Selection: b1-01

- Constant b1-01 is used to select the reference source.

User Constant Number	Name	Change during Operation	Setting Range	Unit	Factory Setting	Valid Access Levels	
						Open Loop Vector	Flux Vector
b1-01	Reference selection		0 to 3	-	1	Q	Q

- Settings

Setting	Reference source
0	Digital Operator
1	Control circuit terminals (analog inputs)
2	Transmission
3	Optional Card

- The frequency reference is input from the control circuit terminals (external terminals), so set b1-01 to 1.

■ Frequency Reference (Voltage), Terminal 13 Signal Level: H3-01

User Constant Number	Name	Change during Operation	Setting Range	Unit	Factory Setting	Valid Access Levels	
						Open Loop Vector	Flux Vector
H3-01	Signal level selection (terminal 13)		0 1	-	0	B	B

- The frequency reference (voltage) is valid when constant b1-01 has been set to 1.
- Set the voltage range for the frequency reference (voltage) signal.

- Settings

Setting	Function
0	0 to 10 VDC input [11-bit + polarity (positive/negative) input]
1	-10 to 10 VDC input (A negative voltage is a reference for reverse rotation.)

■ Frequency Reference (Current), Terminal 14 Signal Level: H3-09, H3-08

- Set terminal 14 to a frequency reference with constant H3-09 to use terminal 14 as the frequency reference terminal.
- The frequency reference setting is 1E.

Function Selection: H3-09

User Constant Number	Name	Change during Operation	Setting Range	Unit	Factory Setting	Valid Access Levels	
						Open Loop Vector	Flux Vector
H3-09	Multi-function analog input (terminal 14)		to 1F	-	1F	A	A

- After setting constant H3-09, set terminal 14 signal level with H3-08.

Signal Level: H3-08

- The frequency reference (current) is valid when constant b1-01 has been set to 1.
- Set the signal level for the frequency reference (current).

User Constant Number	Name	Change during Operation	Setting Range	Unit	Factory Setting	Valid Access Levels	
						Open Loop Vector	Flux Vector
H3-08	Signal level selection (terminal 14)		0 2	-	2	A	A

- Settings

Setting	Function
0	0 to 10 VDC input [10-bit input]
1	-10 to 10 VDC input (A negative voltage is a reference for reverse rotation.)
2	4 to 20 mA input

- When the terminal is being used as a voltage input terminal (setting 0 or 1), jumper J1 must be disconnected on the control board. (See Figure 6.1.) The terminal's input resistor will be destroyed if the terminal is used for a voltage input with jumper J1 connected.
- When frequency references are being input simultaneously from both the voltage terminal 13 and the current terminal 14, the final reference value will be the sum of the two references that are input.
- To switch the frequency reference input between the voltage terminal 13 and the current terminal 14, set a value of 1F in any one of the multi-function inputs (H1-01 through H1-06). The voltage terminal 13 will be used when this multi-function input is OFF and the current terminal 14 will be used when this multi-function input is ON.
- If a 0 to ± 10 VDC input is set, H3-01 must also be set to a 0 to ± 10 VDC input.

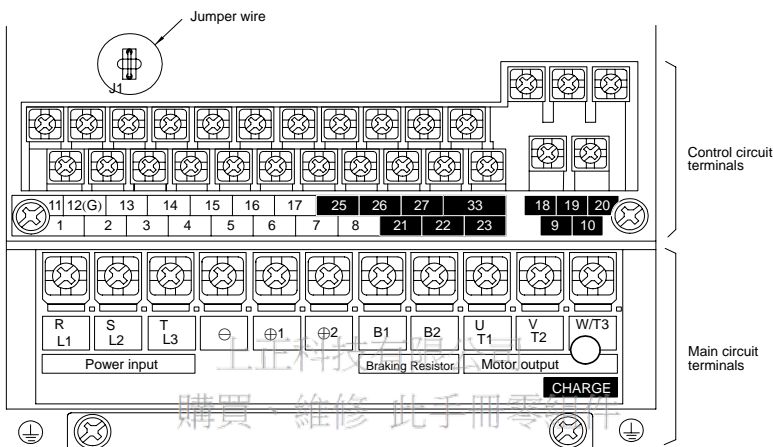

Fig 6.1 Terminal Arrangement of a 200 V Class Inverter of 0.4 kW

■ Function and Signal Level for Multi-function Analog Input (Terminal 16): H3-04, H3-05

- This function is useful when switching between two analog inputs. The input is from terminal 16.
- When using the multi-function input (terminal 16) as the frequency reference terminal, first set the multi-function analog input function to "Auxiliary Reference" by setting constant H3-05 to 0.

Function for Multi-function Analog Input, Terminal 16: H3-05

User Constant Number	Name	Change during Operation	Setting Range	Unit	Factory Setting	Valid Access Levels	
						Open Loop Vector	Flux Vector
H3-05	Multi-function analog input (terminal 16)		0 to 1F	-	0	B	B

- The auxiliary reference is factory-preset to 0.
- After setting H3-05 to 0, set any one of the multi-function inputs (H1-01 through H1-06) to a value of 3 (multi-step speed reference 1).
- When a multi-function analog input has been set to "Auxiliary Reference," it is treated as frequency reference 2 during multi-step speed operation, so it can't be used unless the multi-step speed reference 1 has been set.

Signal Level for Multi-function Analog Input, Terminal 16: H3-04

- Set the signal level for the multi-function analog input.

User Constant Number	Name	Change during Operation	Setting Range	Unit	Factory Setting	Valid Access Levels	
						Open Loop Vector	Flux Vector
H3-04	Signal level selection (terminal 16)		0 1	-	0	B	B

- Settings

Setting	Function
0	0 to 10 VDC input [11-bit + polarity (positive/negative) input]
1	-10 to 10 VDC input (A negative voltage is a reference for reverse rotation.)

Adjusting Analog Inputs: H3-02, H3-03, H3-06, H3-07, H3-10, H3-11, H3-12

- There are three constants used to adjust the analog inputs: The gain, bias (both set separately for each input), and filter time constant (a single value for all of the inputs).
 - The gain and bias can be adjusted separately for each analog input (terminals 13, 14, and 16).
 - Gain: Set the frequency corresponding to a 10 V (20 mA) input as a percentage of the maximum frequency. (The maximum output frequency set in E1-04 is 100%.)
 - Bias: Set the frequency corresponding to a 0 V (4 mA) input as a percentage of the maximum frequency. (The maximum output frequency set in E1-04 is 100%.)
 - Set the gains and biases for terminals 13, 14, and 16 as follows:

User Constant Number	Name	Change during Operation	Setting Range	Unit	Factory Setting	Valid Access Levels	
						Open Loop Vector	Flux Vector
H3-02	Gain for terminal 13		0.0 to 1000.0	%	100.0	B	B
H3-03	Bias for terminal 13		-100.0 to 100.0	%	0.0	B	B
H3-10	Gain for terminal 14		0.0 to 1000.0	%	100.0	A	A
H3-11	Bias for terminal 14		-100.0 to 100.0	%	0.0	A	A
H3-06	Gain for terminal 16*		0.0 to 1000.0	%	100.0	B	B
H3-07	Bias for terminal 16*		-100.0 to 100.0	%	0.0	B	B

* The settings for terminal 16 are valid only when the multi-function analog input has been selected. The gain and bias set here will be disregarded if a frequency reference is selected and the values set for terminal 13 will be used.

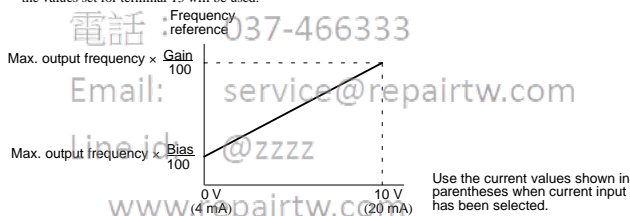

Fig 6.2 Gain and Bias Chart

Analog Input Filter Time Constant: H3-12

- A primary delay digital filter can be set for all three analog inputs (frequency reference (voltage), frequency reference (current), and multi-function analog input)

User Constant Number	Name	Change during Operation	Setting Range	Unit	Factory Setting	Valid Access Levels	
						Open Loop Vector	Flux Vector
H3-12	Analog input filter time constant		0.00 to 2.00	s	0.00	A	A

- This setting is effective when there are sudden changes or noise in the analog input signal.

- Responsiveness decreases as the setting increases.

6.1.3 Frequency Reference from Digital Operator: b1-01, o1-03, d1-01 to d1-09

■ Frequency Reference Source: b1-01

- Select the reference source.

User Constant Number	Name	Change during Operation	Setting Range	Unit	Factory Setting	Valid Access Levels	
						Open Loop Vector	Flux Vector
b1-01	Reference selection		0 to 3	-	1	Q	Q

- Settings

Setting	Reference source
0	Digital Operator
1	Control circuit terminals (analog inputs)
2	Transmission
3	Optional Card

- The frequency reference is input from the Digital Operator, so set b1-01 to 0.

■ Frequency Unit for Reference Setting and Monitoring: o1-03

User Constant Number	Name	Change during Operation	Setting Range	Unit	Factory Setting	Valid Access Levels	
						Open Loop Vector	Flux Vector
o1-03	Frequency unit for reference setting and monitor		0 to 39999	-	0	B	B

- Settings

Setting	Function
0	0.01 Hz units
1	0.01% units (The maximum frequency is 100%.)
2 to 39	r/min units (Set the number of poles.) r/min = 120 frequency reference (Hz)/o1-03 (o1-03 sets the motor poles.)
40 to 39999	Decimal point is set according to the 5th digit value of o1-03. 5th digit = 0: Displays 5th digit = 1: Displays 5th digit = 2: Displays 5th digit = 3: Displays Setting values of 100% frequency are set according to the first to fourth digits of o1-03 [Example 1] When the setting value (100% speed) is 200.0, o1-03 is set to 12000. When o1-03 is set to 12000, 100% speed displays 200.0. 60% speed displays 120.0. [Example 2] When the setting value (100% speed) is 65.00, o1-03 is set to 26500. When o1-03 is set to 26500, 60% speed displays 39.00.

- When the 40 to 39,999 range is used, any unit can be set for the reference frequency. For example, the frequency reference can be displayed or set in units such as mm/s or m/min to coincide with the linear operating speed of the machine.

■ Preset Frequency Reference Values: d1-01 through d1-09

User Constant Number	Name	Change during Operation	Setting Range	Unit	Factory Setting	Valid Access Levels	
						Open Loop Vector	Flux Vector
d1-01	Frequency reference 1		0 to 400.00	o1-03	0.00 Hz	Q	Q
d1-02	Frequency reference 2		0 to 400.00	o1-03	0.00 Hz	Q	Q
d1-03	Frequency reference 3		0 to 400.00	o1-03	0.00 Hz	Q	Q
d1-04	Frequency reference 4		0 to 400.00	o1-03	0.00 Hz	Q	Q
d1-05	Frequency reference 5		0 to 400.00	o1-03	0.00 Hz	B	B
d1-06	Frequency reference 6		0 to 400.00	o1-03	0.00 Hz	B	B
d1-07	Frequency reference 7		0 to 400.00	o1-03	0.00 Hz	B	B
d1-08	Frequency reference 8		0 to 400.00	o1-03	0.00 Hz	B	B
d1-09	Jog frequency reference		0 to 400.00	o1-03	6.00 Hz	Q	Q

- The units for these values are set in o1-03.
- The frequency reference default value and set value will change when o1-03 is changed. For example, if preset reference 1 is set to 6.00 Hz and o1-03 is changed to 1 (0.01% units), the setting for preset reference 1 will become 10.00%.
- When using preset references 2 through 8, be sure to set multi-step speed references 1, 2, and 3 in the multi-function inputs (H1-01 through H1-06) as required.
- When using the jog function, set the jog frequency reference in constant d1-09. When jogging from an external terminal, set the multi-function inputs (H1-01 through H1-06) to "Jog Frequency Reference," "Forward Jog," or "Reverse Jog" as required.
- The multi-function input setting is unnecessary when jogging from the Operator.

上正科技有限公司

購買、維修 此手冊零組件

電話： 037-466333

Email: service@repairtw.com

Line id: @zzzz

www.repairtw.com

6.1.4 Run Source and Sequence Input Responsiveness: b1-02, b1-06, b1-07

■ Run Source: b1-02

User Constant Number	Name	Change during Operation	Setting Range	Unit	Factory Setting	Valid Access Levels	
						Open Loop Vector	Flux Vector
b1-02	Operation method selection		0 to 5	-	1	Q	Q

- Constant b1-02 is used to select the source of the run command.
- When a control circuit terminal (external terminal) is set, the Unit operates with 2-wire forward run/stop and reverse run/stop control. (When the Unit has been initialized for a 3-wire control or a multi-function input is set to 0 (3-wire sequence), the Unit operates with 3-wire run, stop and forward/reverse controls.)
- When using winding change function, set b1-02 to "5" (winding change sequence).
- Settings

Setting	Run source
0	Digital Operator
1	Control circuit terminals (external terminals)
2	Transmission
3	Optional Card
4	MEMOBUS transmission (for CP-717)
5	Winding change sequence

■ Sequence Input Responsiveness (Reading Twice): b1-06

User Constant Number	Name	Change during Operation	Setting Range	Unit	Factory Setting	Valid Access Levels	
						Open Loop Vector	Flux Vector
b1-06	Read sequence input twice		0 1	-	1	A	A

- Set the responsiveness of the control inputs (forward/reverse run and multi-function inputs)
- Settings

Setting	Function
0	Two scans every 2 ms (Use when connecting transistor outputs.)
1	Two scans every 5 ms (Use when connecting contact outputs or switches.)

- Set the responsiveness to match the type of control inputs being used. Use a setting of 1 if there is one or more contact inputs.

■ Operation after Switching to Remote Mode: b1-07

User Constant Number	Name	Change during Operation	Setting Range	Unit	Factory Setting	Valid Access Levels	
						Open Loop Vector	Flux Vector
b1-07	Operation selection after switching to remote mode		0 1	-	0	A	A

- Set the interlock operation to be used after switching from local mode (operation from Digital Operator) to remote mode (operation according to control circuit terminal).
- Settings

Setting	Function
0	No operation even if RUN signal is ON after switching to remote mode. (Operation will start if the RUN signal turns OFF and then back ON after switching to remote mode.)
1	Operate according to the RUN signal after switching to remote mode.

6.1.5 Acceleration/Deceleration Times: C1-01 through C1-08, C1-09, C1-10, C1-11

This section describes setting the acceleration times, deceleration times, and emergency stop time.

■ Acceleration/Deceleration Time Unit: C1-10

User Constant Number	Name	Change during Operation	Setting Range	Unit	Factory Setting	Valid Access Levels	
						Open Loop Vector	Flux Vector
C1-10	Accel/decel time setting unit		0 1	-	1	A	A

- Settings

Setting	Function
0	Sets the acceleration/deceleration time unit to 0.01 seconds.
1	Sets the acceleration/deceleration time unit to 0.1 seconds.

- Set "0" to set more precise acceleration and deceleration times. (This will reduce the setting range.)

■ Acceleration/Deceleration Times: C1-01 through C1-08

- Set individual acceleration and deceleration times.
 - An acceleration time is the time required to go from 0% to 100% of the maximum output frequency.
 - A deceleration time is the time required to go from 100% to 0% of the maximum output frequency.
- Four acceleration times and four deceleration times can be set. When using acceleration/deceleration times 2 through 4, set multi-function inputs (H1-01 through H1-06) to the acceleration/deceleration time selectors 1 and 2.

User Constant Number	Name	Change during Operation	Setting Range	Unit	Factory Setting	Valid Access Levels	
						Open Loop Vector	Flux Vector
C1-01	Acceleration time 1		0.0 to 6000.0	s	10.0	Q	Q
C1-02	Deceleration time 1		0.0 to 6000.0	s	10.0	Q	Q
C1-03	Acceleration time 2		0.0 to 6000.0	s	10.0	B	B
C1-04	Deceleration time 2		0.0 to 6000.0	s	10.0	B	B
C1-05	Acceleration time 3		0.0 to 6000.0	s	10.0	A	A
C1-06	Deceleration time 3		0.0 to 6000.0	s	10.0	A	A
C1-07	Acceleration time 4		0.0 to 6000.0	s	10.0	A	A
C1-08	Deceleration time 4		0.0 to 6000.0	s	10.0	A	A

- The setting range for the acceleration/deceleration times depends on the setting in C1-10 (acceleration/deceleration time unit). The table shows the setting range when the factory setting is used for C1-10.
- If C1-10 is set to "0" (0.01 s) the setting range will be 0.00 to 600.00 s.

■ Emergency Stop Time: C1-09

- Sets the deceleration time that will be used when an emergency stop signal is input or a fault is detected. The deceleration time is the time required to go from 100% to 0% of the maximum output frequency.
- When using an emergency stop input, set a multi-function input (H1-01 through H1-06) to for an emergency stop.
- The emergency stop time is effective for the following faults. Set a stopping method for each.
 - Inverter overheating (OH) pre-alarm: Set in L8-03.
 - Pulse generator faults: Set in F1-02 through F1-04.

User Constant Number	Name	Change during Operation	Setting Range	Unit	Factory Setting	Valid Access Levels	
						Open Loop Vector	Flux Vector
C1-09	Emergency stop time		0.0 to 6000.0	s	10.0	B	B

- The setting range for the emergency stop deceleration time depends upon the setting in C1-10 (acceleration/deceleration time unit). The table shows the setting range when the factory setting is used for C1-10.
- If C1-10 is set to "0" (0.01 s) the setting range will be 0.00 to 600.00 s.

■ Acceleration/Deceleration Time Switching Frequency: C1-11

- When an acceleration/deceleration time switching frequency is set, the acceleration and deceleration times will be changed automatically as the frequency passes the set level.
- If the acceleration/deceleration time selectors 1 and 2 are input via the multi-function inputs, they will have priority.

User Constant Number	Name	Change during Operation	Setting Range	Unit	Factory Setting	Valid Access Levels	
						Open Loop Vector	Flux Vector
C1-11	Accel/decel time switching frequency		0.0 to 400.0	Hz	0.0	A	A

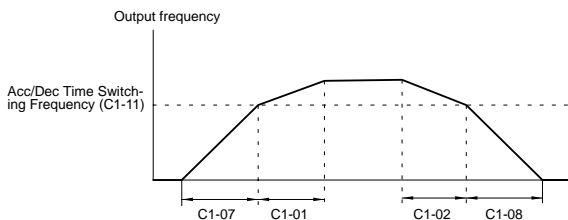

Acceleration/Deceleration Times 1 (C1-01 and C1-02) are used when the output frequency \geq C1-11
 Acceleration/Deceleration Times 4 (C1-07 and C1-08) are used when the output frequency $<$ C1-11

Fig. 6.3 Acceleration/Deceleration Time Switching Frequency

6.1.6 Prohibiting Reverse Operation: b1-04

- Set whether or not to operate the motor in reverse when a reverse reference is input.
- Set this constant to "1" to disable reverse operation when necessary.

User Constant Number	Name	Change during Operation	Setting Range	Unit	Factory Setting	Valid Access Levels	
						Open Loop Vector	Flux Vector
b1-04	Prohibition of reverse operation		0	-	0	B	B

- Settings

Setting	Function
0	Allows reverse operation.

Line id: @zzz

www.repairtw.com

6.1.7 Selecting the Stopping Method: b1-03

- Set the stopping method used when a stop command is input.

User Constant Number	Name	Change during Operation	Setting Range	Unit	Factory Setting	Valid Access Levels	
						Open Loop Vector	Flux Vector
b1-03	Stopping method selection		0	-	0	Q	Q

- Settings

Setting	Function
0	Deceleration to stop

- The following diagrams show the operation of the stopping method.
 - Deceleration to Stop (b1-03 = 0)

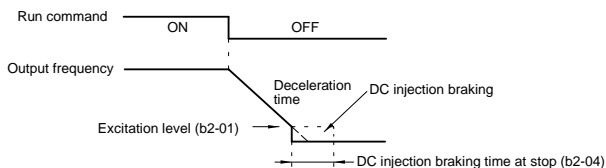

Decelerates to a stop at a rate set with the selected deceleration time.

Fig 6.4 Deceleration to Stop

6.1.8 Multi-function Input Settings: H1-01 through H1-06

- Set the functions for terminals 3 to 8. Set the functions of the multi-function inputs according to the application.

User Constant Number	Name	Change during Operation	Setting Range	Unit	Factory Setting	Valid Access Levels	
						Open Loop Vector	Flux Vector
H1-01	Multi-function input 1 (terminal 3)		0 to 77	-	24	B	B
H1-02	Multi-function input 2 (terminal 4)		0 to 77	-	14	B	B
H1-03	Multi-function input 3 (terminal 5)		0 to 77	-	3 (0)	B	B
H1-04	Multi-function input 4 (terminal 6)		0 to 77	-	4 (3)	B	B
H1-05	Multi-function input 5 (terminal 7)		0 to 77	-	6 (4)	B	B
H1-06	Multi-function input 6 (terminal 8)		0 to 77	-	8 (6)	B	B

- The default settings in parentheses are the default values when the Unit is initialized for 3-wire sequence control.
- The constant settings that are used most often are explained below. Refer to chapter *NO TAG Advanced Operation* or the constant tables for details on the other settings.
 - 3-wire sequence (forward/reverse run command): Set "0"
 - Multi-step speed references 1 to 3 and jog command: Set "3" to "6"
 - Acceleration/Deceleration Time Selectors 1 and 2: Set "7" and "1A"
 - Emergency Stop: Set "15"
 - FORWARD and REVERSE JOG References: Set "12" and "13"
 - Terminal 13/14 Switch: Set "1F"

■ 3-wire Sequence (Forward/Reverse Run Commands): “0”

- When a value of “0” is set for any one of the multi-function inputs (HI-01 through HI-06), 3-wire sequence control is used and the multi-function input terminal for which “0” was set becomes the forward/reverse run command terminal.
- When the Unit is initialized for 3-wire sequence control with A1-03, multi-function input 3 (terminal 5) becomes the input terminal for the forward/reverse run command.

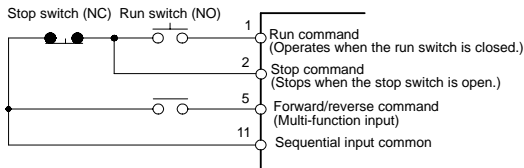

Fig 6.5 3-wire Sequence Wiring Example

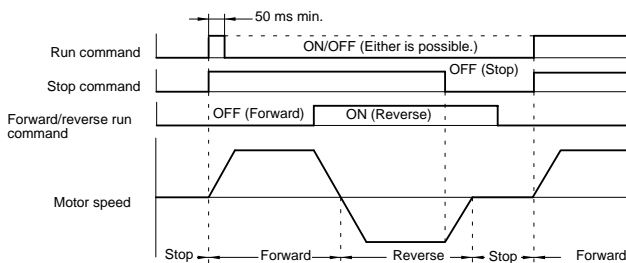

Fig 6.6 Timing Chart for 3-wire Sequence

■ Multi-step Speed References 1 through 3 and JOG Reference: “3” to “6”

- Eight frequency references and one jog frequency reference can be used.
- Set the multi-step speed references 1, 2, and 3 and the JOG reference for the multi-function inputs, and change the status of these inputs to switch between the 9 frequency references.

Terminal	Constant	Setting	Function
5	HI-03	3	Multi-step speed reference 1 (Also used for master-speed/auxiliary-speed switching when an auxiliary reference is set for the multi-function analog input in H3-05.)
6	HI-04	4	Multi-step speed reference 2
7	HI-05	5	Multi-step speed reference 3
8	HI-06	6	JOG reference (This setting has higher priority than the multi-step speed reference.)

Line id: @zzz

www.repairtw.com

- The following table shows which frequency is selected by each possible combination of multi-step speed and JOG reference settings.

Terminal 5 Multi-step speed reference 1	Terminal 6 Multi-step speed reference 2	Terminal 7 Multi-step speed reference 3	Terminal 8 JOG reference	Selected frequency
OFF	OFF	OFF	OFF	Reference 1: d1-01 (master speed frequency)
ON	OFF	OFF	OFF	Reference 2: d1-02 (auxiliary speed frequency)
OFF	ON	OFF	OFF	Reference 3: d1-03
ON	ON	OFF	OFF	Reference 4: d1-04
OFF	OFF	ON	OFF	Reference 5: d1-05
ON	OFF	ON	OFF	Reference 6: d1-06
OFF	ON	ON	OFF	Reference 7: d1-07
ON	ON	ON	OFF	Reference 8: d1-08
-	-	-	ON	Jog frequency: d1-09

Selecting 1-step and 2-step Frequency References

- To use the master frequency (analog terminal 13 or 14), set b1-01 to 1.
- To use frequency reference 1 (d1-01), set b1-01 to 0.
- To use the auxiliary frequency reference (analog terminal 16), use the factory setting.
- To use frequency reference 2 (d1-02), set H3-05 to 1F.

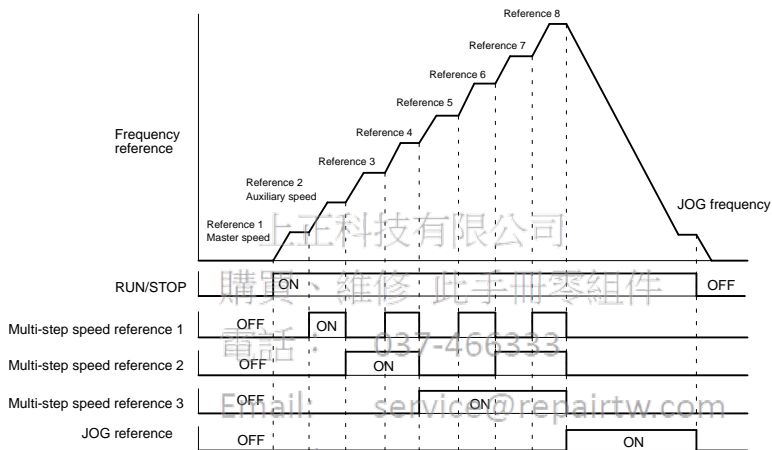
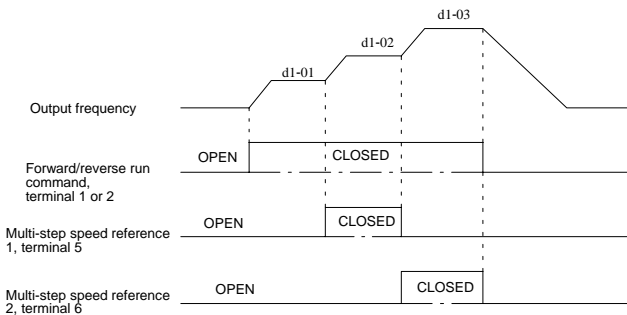

Fig. 6-7 Timing Chart for Multi-step Speed and JOG References

Three-step Speed Operation Example

The following example shows three-step speed operation with frequencies set at Inverter constants.

- Sequence



- Connections

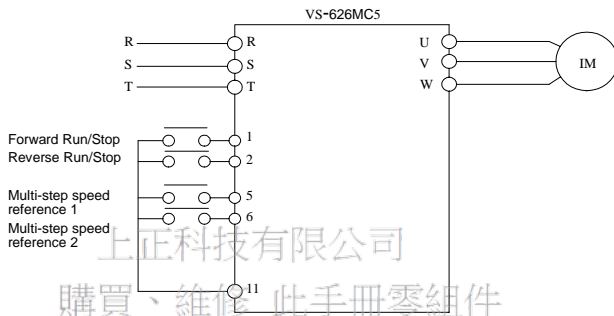

- User Constant Settings

Constant No.	Name	Setting
A1-01	Constant access level	3: Basic (B)
b1-01	Reference selection	0: Operator
d1-01	Frequency reference 1	Hz frequency setting
d1-02	Frequency reference 2	Hz frequency setting
d1-03	Frequency reference 3	Hz frequency setting
H1-03	Multi-function input (terminal 5)	3: Multi-step speed reference 1 (factory setting)
H1-04	Multi-function input (terminal 6)	4: Multi-step speed reference 2 (factory setting)
H3-05	Multi-function input (terminal 16)	1F: Not used

Terminal 6 would not be needed if 2-step speed operation were required.

■ Acceleration/Deceleration Time Selectors 1 and 2: “7” and “1A”

- Four acceleration times and four deceleration times can be set. The multi-function inputs can be set as acceleration/deceleration time selectors 1 and 2 to switch between these acceleration and deceleration times.

Setting	Function
7	Acceleration/Deceleration time selector 1
1A	Acceleration/Deceleration time selector 2

- The following table shows which acceleration and deceleration times are selected by each possible combination of acceleration/deceleration time selectors 1 and 2. The acceleration and deceleration times can be changed while the Inverter is operating.

Accel/Decel Time Selector 1	Accel/Decel Time Selector 2	Acceleration Time	Deceleration Time
OFF or not set	OFF or not set	Acceleration time 1 (C1-01)	Deceleration time 1 (C1-02)
ON	OFF or not set	Acceleration time 2 (C1-03)	Deceleration time 2 (C1-04)
OFF or not set	ON	Acceleration time 3 (C1-05)	Deceleration time 3 (C1-06)
ON	ON	Acceleration time 4 (C1-07)	Deceleration time 4 (C1-08)

■ Emergency Stop: “15” “17”

- When the multi-function input that is set as an emergency stop is turned ON, the motor will decelerate to a stop at the rate set with the deceleration time in C1-09 (emergency stop time).
- To clear the emergency stop, turn OFF the run command, turn OFF the emergency stop input, and then turn ON the run command again.
- Set “17” to make the emergency stop the normally closed condition.

Setting	Function
15	Emergency stop (normally open condition: Decelerates to stop when ON in the emergency stop period C1-09)
17	Emergency stop (normally closed condition: Decelerates to stop when OFF in the emergency stop period C1-09)

■ Forward and Reverse Jog Commands: “12” and “13”

The jogging can be performed in forward or reverse.

Setting	Function
12	Forward jog command: Runs forward at the jog frequency (d1-09).
13	Reverse jog command: Runs in reverse at the jog frequency (d1-09).

- The forward jog and reverse jog commands have priority over other frequency reference commands.
- The inverter will stop operation with the stopping method set in b1-03 if the forward jog and reverse jog commands are both ON for more than 500 ms.
- Turn ON either the forward jog command or the reverse jog command, not both.
- These jog commands can operate the Inverter independently. It isn't necessary for a forward/reverse run command to be input.

■ Terminal 13/14 Switch: “1F” @ ZZZZ

- When this function is set for a multi-function input, that input terminal can be used to switch between terminal 13 and terminal 14.

OFF	The analog input from terminal 13 is used as the master-speed frequency reference.
ON	The analog input from terminal 14 is used as the master speed frequency reference.

- When terminal 14 is used as the frequency reference, set “1F” (frequency reference) in constant H3-09; this constant is the function selector for frequency reference (current) terminal 14. A setting fault (OPE03) will occur if this function is selected without setting “1F” in H3-09.
- When H3-09 is set to “1F” (frequency reference) but none of the multi-function inputs is set to “1F” (terminal 13/14 switch), the sum of the inputs from terminals 13 and 14 will be used as the master-speed frequency reference.

6.2 Open-loop Vector Control

Open-loop vector control is vector control without a pulse generator input. Autotuning is the only setting for basic operation with open-loop vector control.
Always perform autotuning for motor unit separately before vector control operation.

To operate with the greatest speed precision near the rated speed, select a motor with a rated voltage that is at least 20 V below the Inverter's input power supply voltage for 200 V class Inverters and 40 V below for 400 V class Inverters. When the input voltage is the same as the rated voltage, the voltage limit may be applied and vector control won't be established.

6.2.1 Autotuning for general-purpose motors



CAUTION

- Do not connect a load to the motor when performing autotuning. Doing so may result in personal injury or equipment damage.

When motor cannot be disconnected from the load, motor constants can be set by calculation. Contact your YASKAWA representatives for details.

■ Precautions before Autotuning

- The Inverter's autotuning function automatically determines the motor constants while a servo system's autotuning function determines the size of a load, so these autotuning functions are fundamentally different.
- If a load is connected when autotuning is performed, not only will incorrect motor constants be recorded, but the motor may operate erratically or unexpectedly. Disconnect the load before autotuning.
- The motor shaft will rotate when autotuning is performed. Confirm safety before starting autotuning.
- When motor cannot be disconnected from the load, motor constants can be set by calculation. Contact your YASKAWA representatives for details.

■ Inverter Input Voltage Setting: E1-01

- Set the Inverter input voltage (E1-01) to match the power supply voltage.

User Constant Number	Name	Change during Operation	Setting Range	Unit	Factory Setting	Valid Access Levels	
						Open Loop Vector	Flux Vector
E1-01	Input voltage setting		155 to 255 (310 to 510)	VAC	200 (400)	Q	Q

- The voltage settings shown in parentheses are the values for the 400 V class. This setting is used as the reference value for functions such as the protection functions.

■ Motor Selection: E1-02

- Set the type of motor being used. This setting is a reference for overheating protection functions.

User Constant Number	Name	Change during Operation	Setting Range	Unit	Factory Setting	Valid Access Levels	
						Open Loop Vector	Flux Vector
E1-02	Motor Selection (motor overheating protection)		0 to 2	-	0	Q	Q

- Settings

Setting	Function
0	Standard motor (general-purpose motor)
1	Special motor (inverter-exclusive motor)
2	Special motor (vector-exclusive motor)

Required Constant Settings

1. Enter autotuning mode and make the following constant settings:

- Rated Voltage
Set the rated voltage (VAC) shown on the motor nameplate.
- Rated Current
Set the rated current (A) shown on the motor nameplate.
- Rated Frequency
Set the rated frequency (Hz) shown on the motor nameplate.
- Rated Speed
Set the rated speed (r/min) shown on the motor nameplate.
- Number of Poles
Set the number of poles.
- Motor Selection
Select motor 1 or motor 2. (Normally select motor 1.)

2. The following message will appear when the constants have been set:



3. At this point, it is still possible to change the constant settings by pressing the Increment and Decrement Keys to display the desired constant.

4. Press the STOP Key to cancel autotuning, and then press the MENU Key and DATA/ENTER Key. The operation mode display will appear.

- * Rated voltage for vector control motors is approx. 10 to 20% lower than general-purpose motors. Always verify motor voltage listed on the nameplate or test report before use.

Performing Autotuning

- Autotuning will start if the RUN Key is pressed when the "Tuning Ready?" message is being displayed.
- The motor will operate during autotuning, so be sure that it is safe for the motor to operate before pressing the RUN Key.
- The following message will be displayed when the RUN Key is pressed:

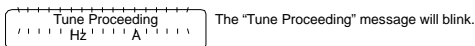

- Autotuning takes up to 1.5 minutes. The message "Tune Successful" will be displayed when autotuning has been completed.
- If autotuning has been completed successfully, press the MENU Key and proceed to the next operation.
- If a fault occurred during autotuning, refer to 6.2.3 *Autotuning Faults* for details on correcting the cause of the fault and perform autotuning again.

6.2.2 Autotuning for machine tool spindle motors

CAUTION

- Do not connect a load to the motor when performing autotuning. Doing so may result in personal injury or equipment damage.

Precautions before Autotuning

- The VS-626MC5's autotuning function automatically determines the motor constants while a servo system's autotuning function determines the size of a load, so these autotuning functions are fundamentally different.
- If a load is connected when autotuning is performed, not only will incorrect motor constants be recorded, but the motor may operate erratically or unexpectedly. Please disconnect load before performing autotuning.
- The motor shaft will rotate when autotuning is performed. Confirm safety before starting autotuning.
- For winding change motors, conduct autotuning of motor 1 and 2.

■ Acquisition of Motor Data

When autotuning motors for machine tool spindles, it is necessary to check the following data for the winding motors (Y-and - windings).

- No-load voltage at base speed
 - Rated current at base speed
 - No-load frequency at base speed
 - Base speed(r/min)
 - Number of poles
 - No-load frequency at max. speed
 - No-load voltage at max. speed
 - Rated voltage (with 100% load)
 - Leakage inductance ($L = L1 + L2$)
- Refer to Fig. 6.8 for details.

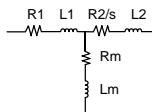

R1	Primary resistance
R2	Secondary resistance
S	Slip
Rm	Iron loss resistance
Lm	excitation inductance

Fig 6.8 Motor equivalent circuit (One phase, Example of Y-winding)

■ Constant setting prior to autotuning

Following constants must be set before performing autotuning.

- Motor leak inductance (E2-06)

Set motor leak inductance using the following formula.

Setting by the motor leak inductance $L (= L1 + L2)$

$$(E2-06) = \frac{\sqrt{3} \times 2 \times \pi \times \text{Rated frequency at base speed (Hz)} \times L (\text{H}) \times \text{Rated current at base speed (A)}}{\text{No-load voltage at base speed (V)}} \times 100(\%)$$

Note: Refer to Fig. 6.8 for details of leakage inductance "L".

Setting by the lock test values

$$(E2-06) = \frac{\sqrt{3} \times \sqrt{(Vs/3Is)^2 - (Ps/3Is)^2} \times \text{Rated current at base speed (A)}}{\text{No-load voltage at base speed (V)}} \times 100(\%)$$

Vs Lock test voltage V
Is Lock test current A
Ps Lock test loss W

The result of the above formula should be from 5 to 25%. Verify the data when the obtained results are too large (or small).

- Carrier frequency

Set carrier frequency to 5.0 kHz.

Carrier frequency during autotuning: C8-30=1 (Carrier frequency is set to a value as set in C6-01)

Carrier frequency upper limit: C6-01=5.0 kHz

■ Required Constant Settings

1. Enter autotuning mode and make the following constant settings:

- Rated Voltage
Set the rated voltage (VAC) at the base speed(r/min).
- Rated Current
Set the rated current (A) at the base speed(r/min).
- Rated Frequency
Set the rated frequency (Hz) at the base speed.
- Rated Speed(r/min)
Set the rated speed (r/min) at the base speed.
- Number of Poles
Set the number of poles.
- Motor Selection
Select motor 1 or 2.

2. The following message will appear when the constants have been set:



 The "Press RUN Key" message will blink.

3. At this point, it is still possible to change the constant settings by pressing the Increment () and Decrement () Keys to display the desired constant.

4. Press the STOP Key to cancel autotuning, and then press the MENU Key and DATA/ENTER Key. The operation mode display will appear.

■ Performing Autotuning

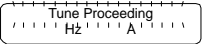
- Autotuning will start if the Run Key is pressed when the "Tuning Ready?" message is being displayed.
- The motor will operate during autotuning, so be sure that it is safe for the motor to operate before pressing the RUN Key.
- The following message will be displayed when the Run Key is pressed:

 The "Tune Proceeding" message will blink.

- Autotuning takes up to 1.5 minutes. The message "Tune Successful" will be displayed when autotuning is completed.
- When autotuning has been completed successfully, record the motor constants. Repeat autotuning for three times and set to the resulting average (value).
- If a fault occurred during autotuning, refer to 6.2.3 Autotuning Faults for details on correcting the cause of the fault and perform autotuning again.
- After autotuning of Motor 1 is completed, perform autotuning of Motor 2 using the same procedures.

■ Adjustment after autotuning

Adjust the following constants when autotuning has completed.

- Max. frequency (E1-04) : No-load frequency at the maximum speed (Hz).
- Max. voltage (E1-05) = No-load voltage at maximum speed (V)

Line id: @zzzz

www.repairtw.com

6.2.3 Autotuning Faults

- One of the fault messages in the following table will be displayed if a fault occurs during autotuning and the motor will stop. In this case, determine the cause of the fault, correct it, and perform autotuning again.
- The fault display can be cleared by pressing the MENU Key.
- The motor constants will revert to their default settings if a fault occurs. Set these constants again before starting autotuning again.

Table 6.2 Troubleshooting Autotuning Faults for Open-loop Vector Control

Fault Display	Probable Cause		Remedy
Data Invalid (Motor data fault)	There was a fault in the data set during autotuning.	There was a fault in the relationship between the rated frequency, rated speed, and number of poles.	Change the settings to conform to the following equation: Rated speed <math>< 120 \times \text{Motor frequency} / \text{Number of poles}</math>
ALARM: Over Load (Excessive tuning load)	The effective load factor exceeded 20% during autotuning.	A load is connected to the motor.	Remove the load.
		There was a setting fault during autotuning.	Check the rated current setting. Change if necessary.
Motor speed (Motor speed fault)	The torque reference value exceeded 100% during autotuning.	There is a motor bearing problem.	Turn the Inverter off and rotate the motor by hand. Replace the motor if it doesn't turn smoothly.
		There is a broken/disconnected motor power wire.	Check and replace wiring components if necessary.
Accelerate (Acceleration fault)	The motor doesn't accelerate within the prescribed time.	A load is connected to the motor.	Remove the load.
		The torque limit function is operating.	Initialize the torque limit constants (H7-01 to H7-04).
Rated Slip (Rated slip fault)	The rated slip setting can't be tuned within the prescribed time.	The acceleration time is too short.	Increase acceleration time 1 (C1-01).
		A load is connected to the motor.	Remove the load.
Saturation -1 (Iron core saturation coefficient 1 fault)	The core-saturation coefficients can't be tuned within the prescribed time.	A load is connected to the motor.	Remove the load.
Saturation -2 (Iron core saturation coefficient 2 fault)		The rated current setting isn't correct.	Check and change the setting if necessary.
Resistance (Line-to-line resistance fault)	The motor terminal resistance or no-load current setting can't be tuned within the prescribed time.	There is a broken/disconnected motor power wire.	Check and replace wiring components if necessary.
No-load Current (No-load current fault)		The rated current setting isn't correct.	Check and change the setting if necessary.
Tune Aborted Minor Fault:	---	There is a broken/disconnected motor power wire.	Check and replace wiring components if necessary.
Tune Aborted V/f Over Setting (Displayed after the completion of autotuning)	Torque reference exceeded 100% and no-load current exceeded 70%.	A minor Inverter fault occurred.	Check the minor fault indicated in the boxes in the display shown at the left.
		Rated voltage and rated frequency settings are not correct.	Check the setting and correct any problems.
		The load is connected to the motor.	Disconnect the motor from the load.

www.repairtw.com

6.3 Flux Vector Control

With flux vector control (vector control with PG), make the settings for the PG Speed Control Card, select the zero-speed operation method, set the various autotuning constants, and then adjust the gain of the speed control loop.

Always perform auto-tuning for motor unit separately before vector control operation. Vector control is not effective without autotuning.

To ensure high-accuracy speed control, use a motor specifically designed for vector control with an integrated PG.

When setting up a PG (encoder), connect it directly to the motor shaft. If the PG is connected to the motor via gearing or belts, responses can be delayed by backlash or torsion; the delayed responses can generate oscillation and make control impossible.

When continuously operating the unit at low speeds with a heavy load, reduce the carrier frequency (C6-01) to 2 kHz.

6.3.1 PG Speed Control Card Settings

■ Available PG Speed Control Cards

- There are 4 models of PG Speed Control Cards, but only 2 models can be used with vector control.
 - PG-B2: Phase-A/Phase-B pulse inputs, complementary output
 - PG-X2: Phase-A/Phase-B/Phase-Z pulse inputs, line drivers
- Select the Card according to the application and install it in the Inverter as described in 3.7 *Installing and Wiring PG Speed Control Cards*.

■ PG Constant: F1-01

- Set the PG (pulse generator or encoder) constant in pulses/revolution.
- Set the number of phase-A or phase-B pulses in one motor revolution.

User Constant Number	Name	Change during Operation	Setting Range	Unit	Factory Setting	Valid Access Levels	
						Open Loop Vector	Flux Vector
F1-01	PG constant		0 to 60000	p/r	600		Q

■ PG Rotation Direction: F1-05

- This constant is used to coordinate the PG's rotation direction with the motor's rotation direction. The setting for the standard applicable Yaskawa PG (made by Thermtac) is an advanced phase A for forward rotation.
- Generally, phase A leads when the PG rotates in the clockwise direction (looking from the input axis). When a forward reference is output, the motor rotates in the counterclockwise direction (looking from the output axis).
- Set whether phase A or phase B leads when the motor operates in the forward direction.

User Constant Number	Name	Change during Operation	Setting Range	Unit	Factory Setting	Valid Access Levels	
						Open Loop Vector	Flux Vector
F1-05	PG rotation		0-1		0		B

- Settings

Setting	Function
0	Phase A leads with forward rotation. (Phase B leads with reverse rotation.)
1	Phase B leads with forward rotation. (Phase A leads with reverse rotation.)

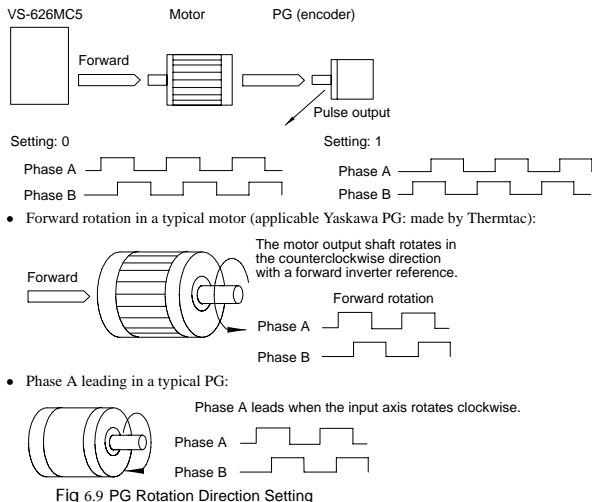

■ PG Pulse Output Monitor Division Rate: F1-06

- This constant is effective only when a PG-B2 PG Control Card is used.
- It sets the division ratio used when the pulse monitor output is connected to a pulse input device.

User Constant Number	Name	Change during Operation	Setting Range	Unit	Factory Setting	Valid Access Levels	
						Open Loop Vector	Flux Vector
F1-06	PG division rate (PG pulse monitor)		1 to 132		1		B

- The first digit in the setting (0 or 1) is n and the second two digits (01 to 32) are m. The division ratio is calculated from n and m with the following equation.

$$\text{Division ratio} = (1+n)/m \quad \text{Setting Ranges} \quad n: 0, 1 \quad m: 1 \text{ to } 32$$

$$F1-06 = \frac{1+n}{m}$$

- Possible division rate settings are as follows: $1/32 \leq F1-06 \leq 1$. For example, if the division rate is 1/2 (a setting of "2"), the monitor output will be half of the number of pulses output from the PG.

■ Fault Detection Functions: F1-02 to F1-04, F1-08 to F1-11, F1-14

PG Disconnection Stopping Method: F1-02, F1-14

- Sets the PG open-circuit detection time and stopping method that is used when a break is detected in the PG cable (PGO).

User Constant Number	Name	Change during Operation	Setting Range	Unit	Factory Setting	Valid Access Levels	
						Open Loop Vector	Flux Vector
F1-02	Operation selection at PG open circuit		0 to 3	-	1		B
F1-14	PG open-circuit detection time		0.0 to 10.0	s	2.0		A

- Settings

Setting	Function
0	Deceleration to stop using deceleration time 1 (C1-02).
1	Coast to stop

Setting	Function
2	Emergency stop using the emergency-stop time (C1-09).
3	Continue operation (PGO is displayed, and continues operation.)

Overspeed Settings: F1-03, F1-8, F1-09

- Overspeed refers to an excessive motor speed.
- Set the conditions (level and time) for detecting overspeed and the stopping method that is used when an overspeed is detected.

User Constant Number	Name	Change during Operation	Setting Range	Unit	Factory Setting	Valid Access Levels	
						Open Loop Vector	Flux Vector
F1-03	Operation selection at overspeed		0 to 3	-	1		B
F1-08	Overspeed detection level		0 to 120	%	115		A
F1-09	Overspeed detection delay time		0.0 to 2.0	s	0.0		A

- Settings

Setting	Function
0	Deceleration to stop using deceleration time 1 (C1-02).
1	Coast to stop
2	Emergency stop using the emergency-stop time (C1-09).
3	Continue operation (OS is displayed, and continues operation.)

- F1-08 and F1-09 Settings

Constant F1-08 sets the overspeed detection level as a percentage of the maximum output frequency. Constant F1-09 sets the length of time in seconds that the motor speed must exceed the overspeed detection level in order to generate an overspeed fault.

PG Speed Deviation Settings: F1-04, F1-10, F1-11

- PG speed deviation refers to the difference between the actual motor speed and the reference speed.
- These constants set the conditions (level and time) for detecting PG speed deviation and the stopping method that is used when a PG speed deviation is detected.

User Constant Number	Name	Change during Operation	Setting Range	Unit	Factory Setting	Valid Access Levels	
						Open Loop Vector	Flux Vector
F1-04	Operation selection at deviation		0 to 3		3		B
F1-10	Excessive speed deviation detection level		0 to 50	%	10		A
F1-11	Excessive speed deviation detection delay time		0.0 to 10.0	s	0.5		A

- Settings (F1-04)

Setting	Function
0	Deceleration to stop using deceleration time 1 (C1-02).
1	Coast to stop
2	Emergency stop using the emergency-stop time (C1-09).
3	Continue operation (Displays "DEV" and continues control.)

- F1-10 and F1-11 Settings

Constant F1-10 sets the PG speed deviation detection level as a percentage of the maximum output frequency. Constant F1-11 sets the length of time in seconds that the difference between the motor speed and reference speed must exceed the PG speed deviation detection level in order to detect a PG speed deviation (DEV).

6.3.2 Setting the Zero-speed Operation Constants

- With flux vector control, operation is possible even when the frequency reference is zero (below the minimum output frequency).
- Set the operation methods for the minimum output frequency.

■ Stopping Method Selection: b1-03

- Set the stopping method used when a stop command is input.

User Constant Number	Name	Change during Operation	Setting Range	Unit	Factory Setting	Valid Access Levels	
						Open Loop Vector	Flux Vector
b1-03	Stopping method selection		0 to 3	-	0	Q	Q

- Settings

Setting	Function
0	Deceleration to stop
1	Coast to stop
2	DC injection braking stop (This setting can't be made with flux vector control.)
3	Coast to stop with timer (This setting can't be made with flux vector control.)

■ Zero-speed Operation: b1-05 and Minimum Output Frequency: E1-09

- Set the operation method used when the frequency reference is below the minimum output frequency.

User Constant Number	Name	Change during Operation	Setting Range	Unit	Factory Setting	Valid Access Levels	
						Open Loop Vector	Flux Vector
b1-05	Operation selection for setting of E1-09 or less		0 to 3	-	0		A

- Settings

Setting	Function
0	Operate according to the frequency reference. (E1-09 is invalid.)
1	Interrupt the output. (Coast when the frequency reference is below E1-09.)
2	Operate at E1-09 frequency. (Output the frequency set in E1-09.)
3	Zero-speed operation (Zero reference value when the frequency reference is below E1-09.)

Minimum Output Frequency (FMIN): E1-09

- Set the minimum output frequency according to the requirements of the application.

User Constant Number	Name	Change during Operation	Setting Range	Unit	Factory Setting	Valid Access Levels	
						Open Loop Vector	Flux Vector
E1-09	Min. output frequency		0.0 to 400.0	Hz	0.0	Q	A

Line id: @zzzz

www.repairtw.com

■ Initial Excitation Settings: b2-01, b2-03, b2-04

- Set the zero speed level, DC injection braking time at startup, and the DC injection braking time when stopping.

User Constant Number	Name	Change during Operation	Setting Range	Unit	Factory Setting	Valid Access Levels	
						Open Loop Vector	Flux Vector
b2-01	Zero speed level (DC injection braking starting frequency)		0.0 to 10.0	Hz	0.5	B	B
b2-03	DC injection braking time at start		0.00 to 10.00	s	0.00	B	B
b2-04	DC injection braking time at stop		0.00 to 10.00	s	0.50	B	B

- With flux vector control, the DC injection braking function is replaced by the initial excitation function and zero speed function.
- The timing of the initial excitation function depends on the zero-speed operation method selected in b1-05 (zero-speed operation), as shown in Figure 6.10.
- The initial excitation function stops a motor that is rotating because of inertia.

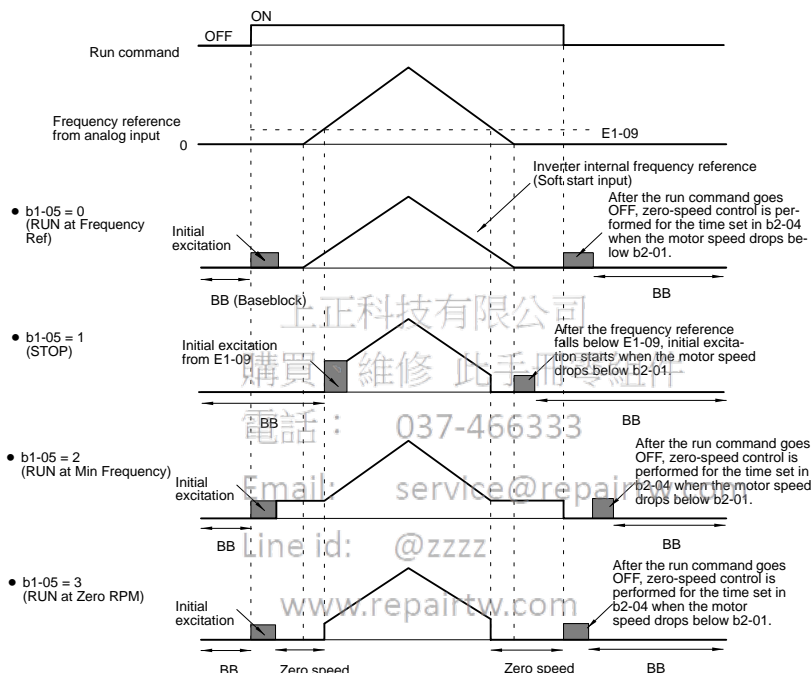

Fig 6.10 Settings for Initial Excitation and Zero-speed Control

- Initial excitation is started from b2-01 (zero speed level) when decelerating. A setting of b2-01 < E1-09 is valid only with flux vector control.
- The current level for the initial excitation function is set in E2-03 (motor no-load current).
- The DC injection braking current (b2-02) isn't used with flux vector control and can't be set.

6.3.3 Autotuning for general-purpose motors

Autotuning for general purpose motors



CAUTION

- Do not connect a load to the motor when performing autotuning. Doing so may result in personal injury or equipment damage.

When motor cannot be disconnected from the load, motor constants can be set by calculation. Contact your YASKAWA representatives for details.

■ Precautions Before Autotuning

- The Inverter's autotuning function automatically determines the motor constants while a servo system's autotuning function determines the size of a load, so these autotuning functions are fundamentally different.
- If a load is connected when autotuning is performed, not only will incorrect motor constants be recorded, but the motor may operate erratically or unexpectedly. Disconnect the load before autotuning.
- The motor shaft will rotate when autotuning is performed. Confirm safety before starting autotuning.
- When motor cannot be disconnected from the load, motor constants can be set by calculation. Contact your YASKAWA representatives for details.

■ Inverter Input Voltage Setting: E1-01

- Set the Inverter input voltage to match the power supply voltage.

User Constant Number	Name	Change during Operation	Setting Range	Unit	Factory Setting	Valid Access Levels	
						Open Loop Vector	Flux Vector
E1-01	Input voltage setting		155 to 255 (310 to 510)	VAC	200 (400)	Q	Q

- The voltage settings shown in parentheses are for 400 V class Inverters.
- This setting is used as the reference value for functions such as the protection functions.

■ Motor Selection (Motor Overheating Protection): E1-02

- Set the type of motor being used. This setting is a reference for overheating protection functions.

User Constant Number	Name	Change during Operation	Setting Range	Unit	Factory Setting	Valid Access Levels	
						Open Loop Vector	Flux Vector
E1-02	Motor selection (motor overheating protection)		0 to 2	-	0	Q	Q

- Settings

Setting	Function
0	Standard motor (general-purpose motor)
1	Special motor (inverter-exclusive motor)
2	Special motor (vector-exclusive motor)

Line id: @zzzz

www.repairtw.com

■ Required Constant Settings

- Enter autotuning mode and make the following constant settings:
 - Rated Voltage *
Set the rated voltage (VAC) shown on the motor nameplate.
 - Rated Current
Set the rated current (A) shown on the motor nameplate.
 - Rated Frequency
Set the rated frequency (Hz) shown on the motor nameplate.
 - Rated Speed
Set the rated speed (r/min) shown on the motor nameplate.
 - Number of Poles
Set the number of poles.
 - Motor Selection
Select motor 1 or motor 2. (Normally select motor 1.)
 - PG Pulses/Rev:
Set the number of A-phase or B-phase pulses per revolution.
- The following message will appear when the constants have been set:

 The "Press RUN Key" message will blink.

- At this point, it is still possible to change the constant settings by pressing the Increment and Decrement Keys to display the desired constant.
- Press the STOP Key to cancel autotuning, and then press the MENU Key and DATA/ENTER Key. The operation mode display will appear.
 - * Rated voltage for vector control motors is approx. 10 to 20% lower than general-purpose motors. Always verify motor voltage listed on the nameplate or test report before use.

■ Performing Autotuning

- Autotuning will start if the Run Key is pressed when the "Tuning Ready?" message is being displayed.
- The motor will operate during autotuning, so be sure that it is safe for the motor to operate before pressing the Run Key.
- The following message will be displayed when the Run Key is pressed:

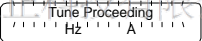
 The "Tune Proceeding" message will blink.

- Autotuning takes up to 1.5 minutes. The message "Tune Successful" will be displayed when autotuning is completed.
- If autotuning has been completed successfully, press the Menu Key and proceed to the next operation.
- If a fault occurred during autotuning, refer to *Table 6.3 Autotuning Faults* for details on correcting the cause of the fault and perform autotuning again.

Email: service@repairtw.com

Line id: @zzzz

www.repairtw.com

6.3.4 Autotuning for machine tool spindle motors



CAUTION

- Do not connect a load to the motor when performing autotuning. Doing so may result in personal injury or equipment damage.

■ Precautions before Autotuning

- The VS-626MC5's autotuning function automatically determines the motor constants while a servo system's autotuning function determines the size of a load, so these autotuning functions are fundamentally different.
- If a load is connected when autotuning is performed, not only will incorrect motor constants be recorded, but the motor may operate erratically or unexpectedly. Please disconnect load before performing autotuning.
- The motor shaft will rotate when autotuning is performed. Confirm safety before starting autotuning.
- For winding change motors, conduct autotuning of motor 1 and 2.

■ Acquisition of Motor Data

When autotuning motors for machine tool spindles, it is necessary to check the following data for the winding motors (Y- and Δ -windings).

- Leakage inductance ($L = L1 + L2$)
Refer to Fig.6.11 for details.
- Rated frequency at base speed (Hz)
- Rated current at base speed (A)
- No-load voltage at base speed (V)
- No-load frequency at base speed (Hz)
- Base speed (r/min)
- Number of poles
- No-load frequency at max. speed (Hz)
- No-load voltage at max. speed (V)



Fig. 6.11 Motor equivalent circuit (For one phase, converted to Y-winding)

上海科技有

購買、維修 此乎帶零組件

電話： 037-466333

Email: service@repairtw.com

Line id: @zzzz

www.repairtw.com

■ Constant setting prior to autotuning

Following constants must be set before performing autotuning.

- Motor leak inductance (E2-06)

Set motor leak inductance using the following formula.

Setting by the motor leak inductance L (= L1 + L2)

$$(E2-06) = \frac{\sqrt{3} \times 2 \times \pi \times \text{Rated frequency at base speed (Hz)} \times L(H) \times \text{Rated current at base speed (A)}}{\text{No-load voltage at base speed (V)}} \times 100(\%)$$

Note : Refer to Fig.6.11 for details of leakage inductance "L".

Setting by the lock test values

$$(E2-06) = \frac{\sqrt{3} \times \sqrt{(Vs^2/3Is^2) - (Ps/3Is^2)} \times \text{Rated current at base speed (A)}}{\text{No-load voltage at base speed (V)}} \times 100(\%)$$

Vs Lock test voltage V

Is Lock test current A

Ps Lock test loss W

The result of the above formula should be from 5 to 25%. Verify the data when the obtained results are too large (or small).

- Carrier frequency

Set carrier frequency to 5.0 kHz.

Carrier frequency during autotuning: C8-30=1 (Carrier frequency is set to a value as set in C6-01)

Carrier frequency upper limit: C6-01=5.0 kHz

■ Required Constant Settings

1. Enter autotuning mode and make the following constant settings:

- Rated Voltage
Set the rated voltage (VAC) at the base speed(r/min).
- Rated Current
Set the rated current (A) at the base speed(r/min).
- Rated Frequency
Set the rated frequency (Hz) at the base speed.
- Rated Speed(r/min)
Set the rated speed (r/min) at the base speed.
- Number of Poles
Set the number of poles.
- Motor Selection
Select motor 1 or 2.
- Number of PG pulse
Set the number PG pulse.

2. The following message will appear when the constants have been set:

Tuning Ready?
Press RUN Key

The "Press RUN Key" message will blink.

3. At this point, it is still possible to change the constant settings by pressing the Increment () and Decrement () Keys to display the desired constant.

4. Press the STOP Key to cancel autotuning, and then press the MENU Key and DATA/ENTER Key. The operation mode display will appear.

■ Performing Autotuning

- Autotuning will start if the Run Key is pressed when the "Tuning Ready?" message is being displayed.
- The motor will operate during autotuning, so be sure that it is safe for the motor to operate before pressing the RUN Key.
- The following message will be displayed when the Run Key is pressed:

Tune Proceeding
Hz

The "Tune Proceeding" message will blink.

- Autotuning takes up to 1.5 minutes. The message "Tune Successful" will be displayed when autotuning is completed.
- When autotuning has been completed successfully, record the motor constants. Repeat autotuning for three times and set to the resulting average (value).

- If a fault occurred during autotuning, refer to 6.3.5 Autotuning Faults for details on correcting the cause of the fault and perform autotuning again.
- After autotuning of Motor 1 is completed, perform autotuning of Motor 2 using the same procedures.

■ Adjustment after autotuning

1. Adjust the following constants when autotuning has completed.
 - Max. frequency (E1-04) = No-load frequency at the maximum speed (Hz)
 - Max. voltage (E1-05) = No-load voltage at maximum speed (V)
2. Adjust the ASR gain (C5-01, C5-03) within the range below.
(C5-01C5-03) = Factory setting (20.00) factory setting Max. Speed/ base speed

6.3.5 Autotuning Faults

- One of the fault messages in the following table will be displayed if a fault occurs during autotuning and the motor will stop. In this case, determine the cause of the fault, correct it, and perform autotuning again.
- The fault display can be cleared by pressing the MENU Key.
- The motor constants will revert to their default settings if a fault occurs. Set these constants again before starting autotuning again.

Table 6.3 Troubleshooting Autotuning Faults for Flux Vector Control

Fault Display	Probable Cause		Remedy
Data Invalid (Motor data fault)	There was a fault in the data set during autotuning.	There was a fault in the relationship between the rated frequency, rated speed, and number of poles.	Change the settings to conform to the following equation: Rated speed < 120 × Motor frequency/Number of poles
ALARM: Over Load (Excessive tuning load)	The effective load factor exceeded 20% during autotuning.	A load is connected to the motor shaft.	Remove the load.
		There was a setting fault during autotuning.	Check the rated current setting. Change if necessary.
Motor speed (Motor speed fault)	The torque reference value exceeded 100% during autotuning.	There is a motor bearing problem.	Turn the Inverter off and rotate the motor by hand. Replace the motor if it doesn't turn smoothly.
		There is a broken/disconnected motor power wire.	Check and replace wiring components if necessary.
Accelerate (Acceleration fault)	The motor doesn't accelerate within the prescribed time.	A load is connected to the motor shaft.	Remove the load.
		The torque limit function is operating.	Initialize the torque limit constants (H7-01 to H7-04).
Rated Slip (Rated slip fault)	The rated slip setting can't be tuned within the prescribed time.	The acceleration time is too short.	Increase acceleration time 1 (C1-01).
		A load is connected to the motor shaft.	Remove the load.
Saturation -1 (Iron core saturation coefficient 1 fault)	The core-saturation coefficients can't be tuned within the prescribed time.	A load is connected to the motor shaft.	Remove the load.
		The rated current setting isn't correct.	Check and change the setting if necessary.
Saturation -2 (Iron core saturation coefficient 2 fault)		There is a broken/disconnected motor power wire.	Check and replace wiring components if necessary.
Resistance (Line-to-line resistance fault)	The motor terminal resistance or no-load current setting can't be tuned within the prescribed time.	The rated current setting isn't correct.	Check and change the setting if necessary.
No-load Current (No-load current fault)		There is a broken/disconnected motor power wire.	Check and replace wiring components if necessary.
Motor Direction Fault Motor direction fault		There is a faulty connection between the Inverter and PC (A or B phase) or the Inverter and Motor (U, V, or W phase).	<ul style="list-style-type: none"> • Check the PG wiring. • Check the motor wiring. • Check the PG rotation direction and constant F1-05.
PG Circuit Fault PGO: PG break detected)	Pulses aren't being input from the PG even though a rotation output is being sent to the motor.	<ul style="list-style-type: none"> • The cable to the PG is broken/disconnected. • The PG's power supply is broken/disconnected. 	Check the wiring and correct any problems.
Tune Aborted Minor Fault:		A minor Inverter fault occurred.	Check the minor fault indicated in the boxes in the display shown at the left.

Fault Display	Probable Cause		Remedy
Tune Aborted V/f Over Setting (Displayed after completion of autotuning)	Torque reference exceeded 100%, and no-load current exceeded 70%.	Rated voltage and rated frequency settings are not correct.	Check the setting and correct any problems.
		The load is connected to the motor.	Disconnect the motor from the load.

6.3.6 Speed Control (ASR) Structure

- The following block diagram shows the structure of the speed control.

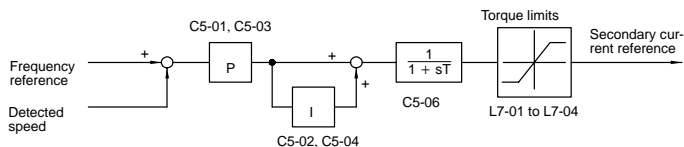

In vector flux control, the ASR's P gain is the maximum frequency standard.

Fig 6.12 Speed Control Structure

■ Gain Settings: C5-01, C5-02

- Set the proportional gain and the integral time of the speed control (ASR).

User Constant Number	Name	Change during Operation	Setting Range	Unit	Factory Setting	Valid Access Levels	
						Open Loop Vector	Flux Vector
C5-01	ASR proportional (P) gain 1		0.00 to 300.00	Multiple	20.00		B
C5-02	ASR integral (I) time 1		0.000 to 10.000	s	0.500		B

■ Low-speed Gain Settings: C5-03, C5-04, C5-07

- Use these constants to set different proportional gain and integral time settings for low-speed operation. Constant C5-03 sets the low-speed proportional gain of the speed loop (ASR), and C5-04 sets the low-speed integral time.
- Set constant C5-07 to the frequency at which to switch to the low-speed ASR proportional gain and integral time.

User Constant Number	Name	Change during Operation	Setting Range	Unit	Factory Setting	Valid Access Levels	
						Open Loop Vector	Flux Vector
C5-03	ASR proportional (P) gain 2		0.00 to 300.00	Multiple	20.00		B
C5-04	ASR integral (I) time 2		0.000 to 10.000	s	0.500		B
C5-07	ASR switching frequency		0.0 to 400.0	Hz	0.0		A

www.repairtw.com

- Figure 6.13 shows how the proportional gain and integral time approach the ASR proportional gain 2 and ASR integral time 2 linearly.

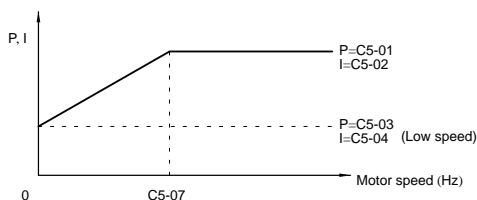

If C5-07 is set to 0.0, ASR proportional gain 1 and ASR integral time 1 are used for the proportional gain and integral time at all frequencies.

Fig 6.13 Gain Settings at Low Frequencies

Multi-function Input Settings: H1-01 Terminal 3 to H1-06 Terminal 8

ASR Integral Reset Setting: "E"

- When one of the multi-function inputs is set to "E," the input can be used to switch the speed control loop between P control and PI control.
- P control (integral reset) is used when the multi-function input is ON.

ASR Proportional Gain Switch Setting: "77"

- When one of the multi-function inputs is set to "77," the input can be used to switch between proportional gain 1 and proportional gain 2.
- Proportional gain 2 (C5-03) is used when the multi-function input is ON. This input has higher priority than the ASR switching frequency set in C5-07.

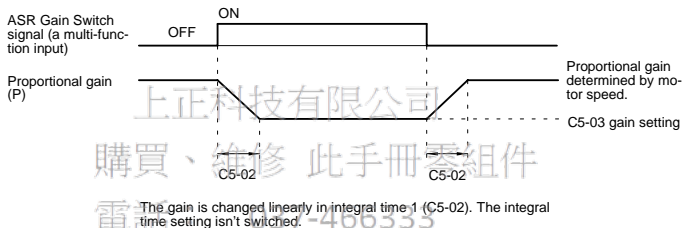

Fig 6.14 ASR Proportional Gain Switch

Speed Control (ASR) Responsiveness: C5-06

User Constant Number	Name	Change during Operation	Setting Range	Unit	Factory Setting	Valid Access Levels	
						Open Loop Vector	Flux Vector
C5-06	ASR primary delay time		0.000 to 0.500	s	0.004		A

- Normally it isn't necessary to make this adjustment.
- Constant C5-06 can be used when adjusting the gain doesn't remove motor oscillation, or adjusting the gain removes oscillation but results in poor responsiveness.
- A high C5-06 setting lowers the responsiveness of the speed control, but makes it difficult for oscillation to occur.

6.3.7 Speed Control (ASR) Gain

■ Gain Adjustment Procedure

Use the following procedure to adjust the gain with the mechanical system and actual load connected.

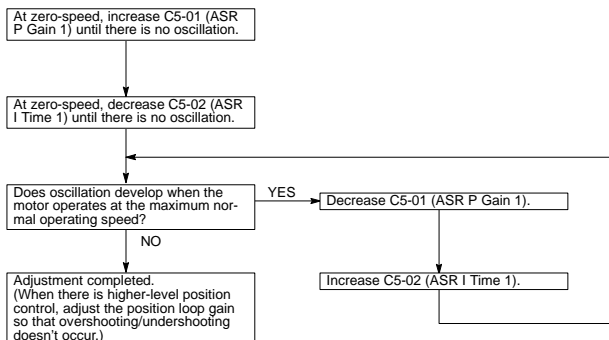

Fig 6.15 Gain Adjustment Procedure

■ Fine Adjustments

- When you want even finer gain adjustment, adjust the gain while observing the speed waveform.
- Constant settings like those shown in the following table will be necessary to monitor the speed waveform.

Constant	Setting	Explanation
H4-01 Analog output selection (terminal 21)	2	Settings that allow multi-function analog output 1 to be used to monitor the output frequency.
H4-02 Analog output gain (terminal 21)	1.00	
H4-03 Analog output bias (terminal 21)	0.0	
H4-04 Analog output selection (terminal 23)	5	Settings that allow multi-function analog output 2 to be used to monitor the motor speed.
H4-05 Analog output gain (terminal 23)	1.00	
H4-06 Analog output bias (terminal 23)	0.0	
H4-07 Analog output level selection	1	This setting allows a 0 to ± 10 V signal range to be monitored.

- The multi-function analog outputs have the following functions with these constant settings.
 - Multi-function analog output 1 (terminal 21): Outputs Inverter's output frequency (0 to ± 10 V).
 - Multi-function analog output 2 (terminal 23): Outputs actual motor speed (0 to ± 10 V). Terminal 22 is the multi-function analog output common.
- We recommend monitoring both the output frequency and the motor speed to monitor the response delay or deviations from the reference value, as shown in the following diagram.



Fig 6.16 Example Monitor Waveforms

Adjusting ASR Proportional Gain 1 (C5-01)

- This gain setting adjusts the responsiveness of the speed control (ASR).
- The responsiveness is increased when this setting is increased. Usually this setting is higher for larger loads. Oscillation will occur if this setting is increased too much.
- The following diagram shows the type of changes that can occur in the response when the ASR proportional gain is changed.

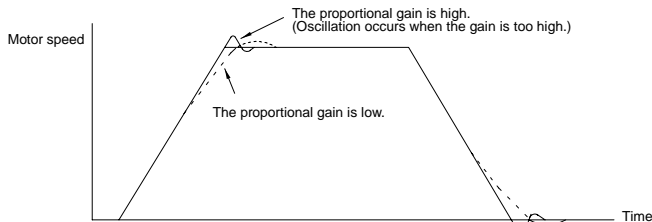

Fig 6.17 Responsiveness for Proportional Gain

Adjusting ASR Integral Time 1 (C5-02)

- This constant sets the speed control (ASR) integral time.
- Lengthening the integral time lowers the responsiveness, and weakens the resistance to external influences. Oscillation will occur if this setting is too short.
- The following diagram shows the type of changes that can occur in the response when the ASR integral time is changed.

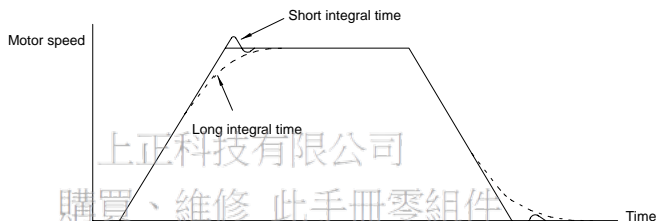

Fig 6.18 Responsiveness for Integral Time

■ Different Gain Settings for Low-speed and High-speed

Switch between low-speed and high-speed gain when oscillation occurs because of resonance with the mechanical system at low speed or high speed.

Setting the Gain Switching Frequency (C5-07)

- Set the switching frequency to about 80% of the motor operating frequency or the frequency at which oscillation occurs.

Low-speed Gain Adjustments (C5-03, C5-04)

- Connect the actual load and adjust these constants at zero-speed. Increase ASR proportional gain 2 (C5-03) until there is no oscillation.
- Decrease ASR integral time 2 (C5-04) until there is no oscillation.

High-speed Gain Adjustments (C5-01, C5-02)

- Adjust these constants at normal operating speed. Increase ASR proportional gain 1 (C5-01) until there is no oscillation.
- Decrease ASR integral time 1 (C5-02) until there is no oscillation.
- Refer to *Fine Adjustments* on page - 34 for details on making fine adjustments of high-speed operation.

7

Advanced Operation

This chapter describes the user constants used for specific control methods in VS-626MC5 application.

7.1	Open-loop Vector Control	7 - 2
7.1.1	Torque Limit Function	7 - 3
7.1.2	Adjusting Speed Feedback	7 - 5
7.1.3	Setting/Adjusting Motor Constants	7 - 5
7.1.4	Operation Selection when Output Voltage Saturated	7 - 8
7.1.5	Starting Torque Compensation Function (for SPEC: F)	7 - 9
7.2	Flux Vector Control	7 - 10
7.2.1	Torque Limit Function	7 - 11
7.2.2	Setting/Adjusting Motor Constants	7 - 12
7.2.3	Operation Selection when Output Voltage Saturated	7 - 16
7.3	Common Functions	7 - 17
7.3.1	Application Constants: b	7 - 18
7.3.2	Tuning Constants: c	7 - 21
7.3.3	Reference Constants: d	7 - 24
7.3.4	Option Constants: f	7 - 26
7.3.5	External Terminal Functions: H	7 - 31
7.3.6	Protective Functions: L	7 - 48
7.3.7	Operator Constants: o	7 - 60
7.4	Optional Functions	7 - 64
7.4.1	Winding Change Function	7 - 64
7.4.2	Wiring for Winding Change	7 - 66
7.4.3	Setting/Adjusting the Winding Change Constants	7 - 69

7.1 Open-loop Vector Control

The functions that can be used with open-loop vector control are listed in *Table 7.1*. Details on functions that are specific to open-loop vector control (i.e. those marked with a) are provided in the following table.

Table 7.1 Open-loop Vector Control Functions

Group	Function	Comments	Control Method	
			Open Loop Vector	Flux Vector
b	b1 Sequence	Settings such as the reference input method		
	b2 DC Injection Braking	DC injection braking function settings		
	b3 Speed Search	Speed search function settings		
	b8 Energy Saving	Not used. (Can't be set.)		
C	C1 Accel/Decel	Acceleration/deceleration time settings		
	C2 S-Curve Acc/Dec	S-curve characteristics for acceleration/deceleration times		
	C3 Motor-Slip Compensation	Slip compensation function settings		
	C4 Torque Compensation	Torque compensation function settings		
	C5 Speed Controls	Not used. (Can't be set.)		
	C6 Carrier Frequency	Carrier frequency settings		
	C8 Factory Tuning	Adjustment for open-loop vector control		
	d1 Preset Reference	Frequency reference settings (when using Operator)		
d	d2 Reference Limits	Frequency upper and lower limit settings		
	d3 Jump Frequencies	Prohibited frequency settings		
	d4 Reference Frequency Hold Function	Up/Down, Accel/Decel stop hold frequency setting		
	E	E1 V/f Pattern	Motor constant settings	
E2 Motor Setup		(Motor constants are set by the autotuning function.)		
E3 Motor 2 Control Methods		Control method settings for motor 2.		
E4 Motor 2 V/f Characteristics		V/f characteristics settings for motor 2.		
E5 Motor 2 Motor Constants		Motor constant settings for motor 2.		
F	F1 PG speed control card settings	User constant settings for a PG Card		
	F2 Analog Reference Card AI	User constant settings for an Analog Reference Card		
	F3 Digital Reference Card DI	User constant settings for a Digital Reference Card		
	F4 Analog Monitor Card AO	User constant settings for an Analog Monitor Card		
	F5 Digital Output Card DO	User constant settings for a Digital Output Card		
	F6 Digital Output Card DO	User constant settings for a Digital Output Card		
	F7 Pulse Monitor Card PIO	User constant settings for a Pulse Monitor Card		
	F8 SI-F/SI-G Transmission Card	User constant settings for a Transmission Card		
	F9 CP-916B Transmission Card	User constant settings for a Transmission Card		
H	H1 Multi-function Inputs	Function selection for multi-function inputs		
	H2 Multi-function Outputs	Function selection for multi-function outputs		
	H3 Analog Inputs	Function selection for analog inputs		
	H4 Multi-function Analog Outputs	Function selection for analog outputs		
	H5 MEMOBUS Communications	MEMOBUS communications settings		
L	L1 Motor Protection Functions	Sets thermal functions that protect the motor.		
	L2 Power Loss Ridethru	Selects the power-loss processing method.		
	L3 Stall Prevention	Accel/Decel stall prevention settings and selection		
	L4 Reference Detection	Frequency detection settings and selection		
	L5 Fault Restart	Fault restart function settings		
	L6 Torque Detection	Sets overtorque detection functions 1 and 2 (by torque)		
	L7 Torque Limit	Four-quadrant individual torque limit settings		
	L8 Hardware Protection	Hardware overheating and open-phase protection settings		
o	o1 Monitor Select	Selects the Operator's display and setting methods.		
	o2 Key Selections	Operator's key function selection and other constants		

7.1.1 Torque Limit Function

With open-loop vector control, torque limits can be applied at an arbitrary value because the torque output by the motor is calculated internally.

The torque limit function is useful when the load cannot sustain a torque above a certain level or to maintain the regenerative torque above a certain level. The two ways to apply torque limits are listed below. (The lower torque limit will be used if both of these methods are set.)

- Setting a torque limit with the constants
- Limiting torque with the analog inputs

IMPORTANT

The accuracy of the torque limit is $\pm 5\%$ for output frequencies above 10 Hz, but the accuracy is lower for output frequencies below 10 Hz. Use flux vector control if you want to apply a torque limit at low-speed (below 10 Hz).

■ Torque Limits: L7-01 through L7-04

Torque limits can be set separately for the 4 ways that torque can be applied: forward torque, reverse torque, forward regenerative torque, and reverse regenerative torque.

User Constant Number	Name	Change during Operation	Setting Range	Unit	Factory Setting	Valid Access Levels	
						Open Loop Vector	Flux Vector
L7-01	Forward torque limit		0 to 300	%	200	B	B
L7-02	Reverse torque limit		0 to 300	%	200	B	B
L7-03	Forward regenerative torque limit		0 to 300	%	200	B	B
L7-04	Reverse regenerative torque limit		0 to 300	%	200	B	B

Figure 7.1 shows the relationship between each constant and the output torque.

When the torque limit function is used, the torque limits have priority and motor speed control and compensation will be disregarded, so the acceleration/deceleration times might be lengthened and motor speed might be reduced.

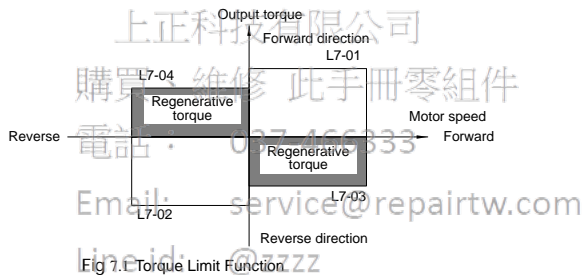

Fig 7.1 Torque Limit Function

www.repairtw.com

■ Limiting Torque with Analog Inputs: H3-05, H3-09

The following two analog inputs that can be used to limit torque.

Multi-function analog input, terminal 16

Frequency reference (current), terminal 14

Use either or both of these inputs as needed with constants H3-05 and H3-09.

User Constant Number	Name	Change during Operation	Setting Range	Unit	Factory Setting	Valid Access Levels	
						Open Loop Vector	Flux Vector
H3-05	Multi-function analog input (terminal 16)		0 to 1F	-	0	B	B
H3-09	Multi-function analog input (terminal 14)		1 to 1F	-	1F	A	A

• Settings

Setting	Function
10	Forward Torque Limit
11	Reverse Torque Limit
12	Regenerative Torque Limit
15	Forward/Reverse Torque Limit

- The above table shows only those settings related to the torque limit function.
- Set the analog input terminal's signal level, gain, and bias to match the actual input signal.
- The factory settings for the input terminal's signal level are as follows:
 - Terminal 16: 0 to 10 V (A 10 V input limits the torque to 100% of the motor's rated torque.)
 - Terminal 14: 4 to 20 mA (A 20 mA input limits the torque to 100% of the motor's rated torque.)

Figure 7.2 shows the relationship between the output torque and each torque limit.

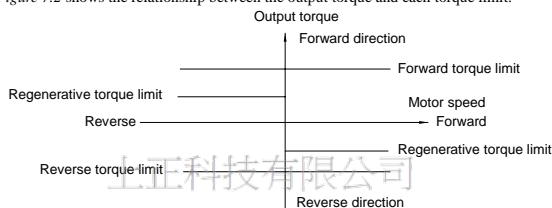

Fig. 7.2 Limiting Torque with Analog Inputs

- When the forward torque limit has been set, the analog input signal acts as the limit value for torque generated in the forward direction. The torque limit input is effective when torque is generated in the forward direction even if the motor is operating in reverse (regenerative torque).
- The torque limit is 100% of the motor's rated torque when the analog input is at its maximum value (10 V or 20 mA). To increase the torque limit above 100%, set the input terminal's gain above 100%. For example, a gain of 150.0% would result in a torque limit of 150% of the motor's rated torque with a 10 V or 20 mA analog input.
 - Gain for multi-function analog input, terminal 16: H3-06
 - Gain for frequency reference (current), terminal 14: H3-10

7.1.2 Adjusting Speed Feedback

With open-loop vector control, internal Inverter data is used to calculate the feedback value. The gain of this automatic frequency regulator (AFR) operation can be fine-tuned according to motor response. (Normally it isn't necessary to change the default setting.)

■ Speed Feedback Detection Control (AFR) Gain: C8-08

User Constant Number	Name	Change during Operation	Setting Range	Unit	Factory Setting	Valid Access Levels	
						Open Loop Vector	Flux Vector
C8-08	AFR gain		0.00 to 10.00	Multi-ple	1.00	A	

- Normally it isn't necessary to change this setting.
- Fine-tune the gain when motor operation is unstable causing hunting to occur or torque/speed responsiveness is low.
 - When hunting occurs, increase the gain by 0.05 increments while checking the motor responsiveness.
 - When responsiveness is low, decrease the gain by 0.05 increments while checking the motor responsiveness.

7.1.3 Setting/Adjusting Motor Constants

■ Adjusting the V/f Pattern: E1-04 through E1-10, E1-13

Normally it isn't necessary to adjust the V/f pattern with open-loop vector control. Adjust the V/f pattern when you want to change the maximum output frequency setting or decrease the Inverter's output voltage or when stalls are occurring during no-load operation.

To increase the motor's rated speed, increase the maximum output frequency in E1-04 in programming mode after autotuning.

It is possible to make user-defined V/f pattern settings (E1-04 through E1-10) in open-loop vector control mode. (The preset V/f patterns cannot be selected.)

User Constant Number	Name	Change during Operation	Setting Range	Unit	Factory Setting	Valid Access Levels	
						Open Loop Vector	Flux Vector
E1-04	Max. output frequency		40.0 to 400.0	Hz	60.0	Q	Q
E1-05	Max. voltage		0.0 to 255.0	VAC	200.0 *1	Q	Q
E1-06	Base frequency		0.0 to 400.0	Hz	60.0	Q	Q
E1-07	Mid. output frequency		0.0 to 400.0	Hz	3.0 *2	A	
E1-08	Mid. output frequency voltage		0.0 to 255.0	VAC	11.0 *1 *2	A	
E1-09	Min. output frequency		0.0 to 400.0	Hz	0.5	Q	A
E1-10	Min. output frequency voltage		0.0 to 255.0	VAC	2.0 *1 *2	A	
E1-13	Base voltage		0.0 to 255.0	VAC	0.0	Q	Q

* 1. These voltages are for 200 V class Inverters; double the voltage for 400 V class Inverters.

* 2. The default setting depends on the Inverter's capacity. The default settings shown in the table are for 200 V class, 0.4 to 1.5 kW Inverters. (See page NO TAG.)

Note 1. The default settings for E1-07 through E1-10 depend on the control method. The default settings shown in the table are for open-loop vector control. (See page NO TAG.)

- The four frequency settings must satisfy the following formula:

$$E1-04 (F_{MAX}) \geq E1-06 (F_A) > E1-07 (F_B) \geq E1-09 (F_{MIN})$$
- When making the V/f characteristics a straight line, set the same value in E1-07 (middle output frequency) and E1-09 (minimum output frequency). In this case, constant E1-08 (middle output frequency voltage) will be disregarded.
- If E1-13 is set to 0.0, the same value as in E1-13 will be set for E1-05. It does not normally need to be set separately.

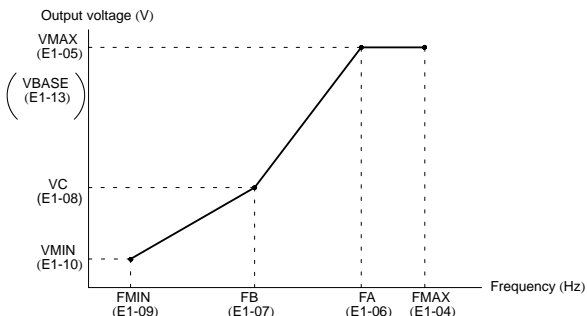

Fig 7.3 User-defined V/f Pattern

Adjusting Output Voltage: VC (E1-08), VMIN (E1-10)

Adjust the output voltage when you want to output more torque at low speed, such as in an elevator, or when torque isn't really necessary and you want to reduce the output voltage to save energy.

Adjustment range: 200 V class Inverters: Initial value 0 to 2 V
400 V class Inverters: Initial value 0 to 4 V

- When generating more torque, gradually increase the voltage but do not exceed 100% of the motor's rated current.
- When saving energy, decrease the voltage but do not cause stalling.

Setting the Maximum Output Frequency

The maximum output frequency can be set from 40.0 to 400.0 Hz. Set this constant in accordance with the motor's maximum rotational speed.

■ Setting Motor Constants: E2-01 through E2-03 (E5-01 through E5-03), E2-05 through E2-08 (E5-05, E5-06)

- The motor constants (function E2) will all be set automatically when autotuning is performed, so it normally isn't necessary to set them manually. Set these constants manually if autotuning can't be completed properly.
- User constant numbers for motor 2 are given in parentheses.

Motor Rated Current: E2-01

User Constant Number	Name	Change during Operation	Setting Range	Unit	Factory Setting	Valid Access Levels	
						Open Loop Vector	Flux Vector
E2-01 (E5-01)	Motor rated current		0.32 to 6.40	A	1.90	Q	Q

- The setting range is 10% to 200% of the Inverter rated output current. The default setting depends upon the Inverter capacity. (The table shows the default setting for 200 V class, 0.4 kW Inverters.) (See page NO TAG.)
- Set the rated current (A) shown on the motor nameplate.

Motor Rated Slip: E2-02

User Constant Number	Name	Change during Operation	Setting Range	Unit	Factory Setting	Valid Access Levels	
						Open Loop Vector	Flux Vector
E2-02 (E5-02)	Motor rated slip		0.00 to 20.00	Hz	2.90	Q	Q

- The default setting depends upon the Inverter capacity. (The table shows the default settings for 200 V class, 0.4 kW Inverters.)
- Calculate the rated slip (E2-02) from the value shown on the motor nameplate with the following equation and set this value.

Rated slip = rated frequency (Hz) - rated speed (r/min) × number of poles/120

Motor No-load Current: E2-03

User Constant Number	Name	Change during Operation	Setting Range	Unit	Factory Setting	Valid Access Levels	
						Open Loop Vector	Flux Vector
E2-03 (E5-03)	Motor no-load current		0.00 to 1500.0	A	1.20	Q	Q

- The default setting depends upon the Inverter capacity.
(The table shows the default settings for 200 V class, 0.4 kW Inverters.)
- Set the no-load current (E2-03) at the rated voltage and rated frequency. Normally this value isn't shown on the motor nameplate, so it might be necessary to contact the motor manufacturer.

Motor Line-to-line Resistance: E2-05

User Constant Number	Name	Change during Operation	Setting Range	Unit	Factory Setting	Valid Access Levels	
						Open Loop Vector	Flux Vector
E2-05 (E5-05)	Motor line-to-line resistance		0.000 to 65.000		9.842	A	A

- The default setting depends upon the Inverter capacity.
(The table shows the default settings for 200 V class, 0.4 kW Inverters.)
- Set the motor terminal resistance (U-V, V-W, and W-U) in constant E2-05. Normally this value isn't shown on the motor nameplate, so it might be necessary to contact the motor manufacturer for the terminal resistance at the insulation class temperature. Use the following equations to calculate the resistance value from the terminal resistance of a test report.
 - E-class insulation: Terminal resistance at 75°C in the test report (Ω) x 0.92
 - B-class insulation: Terminal resistance at 75°C in the test report (Ω) x 0.92
 - F-class insulation: Terminal resistance at 115°C in the test report (Ω) x 0.87

Motor Leakage Inductance: E2-06

User Constant Number	Name	Change during Operation	Setting Range	Unit	Factory Setting	Valid Access Levels	
						Open Loop Vector	Flux Vector
E2-06 (E5-06)	Motor leak inductance		0.0 to 30.0	%	18.2	A	A

- The default setting depends upon the Inverter capacity.
(The table shows the default settings for 200 V class, 0.4 kW Inverters.)
- Set the voltage drop (caused by the motor's leakage inductance) as a percentage of the motor's rated voltage in constant E2-06.
- This constant does not normally required setting because the Inverter automatically compensates during operation.
- Normally this value isn't shown on the motor nameplate, so it might be necessary to contact the motor manufacturer. It is acceptable to set the loss (caused by the motor's leakage inductance) as a percentage.

Motor Iron-core Saturation Coefficients 1, 2: E2-07, E2-08

User Constant Number	Name	Change during Operation	Setting Range	Unit	Factory Setting	Valid Access Levels	
						Open Loop Vector	Flux Vector
E2-07	Motor iron-core saturation coefficient 1		0.00 to 0.50	-	0.50	A	A
E2-08	Motor iron-core saturation coefficient 2		0.00 to 0.75	-	0.75	A	A

- Constants E2-07 and E2-08 are not required when using the motor at or below the rated frequency.
- Set these constants when operating at a frequency higher than the motor's rated frequency. Set the following values:
 - Motor iron-core saturation coefficient 1: Core-saturation coefficient when magnetic flux is 50%.
 - Motor iron-core saturation coefficient 2: Core-saturation coefficient when magnetic flux is 75%.
- Normally these values aren't shown on the motor nameplate, so it might be necessary to contact the motor manufacturer. Operation will be possible with the factory-preset values.

7.1.4 Operation Selection when Output Voltage Saturated

The Inverter cannot output a voltage that is higher than the input voltage. If the output voltage command to the motor (monitor constant U1-06) exceeds the input voltage in the high-speed region, the output voltage will become saturated, and the control unstable with open loop vector control.

Select one of the following methods to prevent this unstable condition.

■ Limited Output Voltage Operation: C3-06 (for SPEC: F)

User Constant Number	Name	Change during Operation	Setting Range	Unit	Factory Setting	Valid Access Levels	
						Open Loop Vector	Flux Vector
C3-06	Limited output voltage operation		0 1	1	0	A	A

- Settings

Setting	Function
0	Disables limited output voltage operation.
1	Enables limited output voltage operation.

- If the limited output voltage operation is disabled and output voltage becomes saturated, slip compensation is automatically disabled to prevent instability.
The output current does not change when the slip compensation is disabled, however precise speed control is no longer possible. Enable limited output voltage operation if precise speed control is required.
- If the limited output voltage operation is enabled, the magnetic flux current of the motor is automatically controlled, and the output voltage command itself is limited, which maintains precise speed control. Check the Inverter current margins as the output current will be maximum 10% higher (with a rated load) than when limited output voltage operation is disabled.

Note 1. C3-06 does not need to be changed if the Unit is used only at medium or low speeds, or when the power supply voltage is 10% or more higher than the rated voltage of the motor, or when speed precision in the high-speed region is not required.

- When the power supply voltage is too low for the rated motor voltage, speed control will not be precise even if limited output voltage operation is enabled.

上正科技有限公司

購買、維修 此手冊零組件

電話： 037-466333

Email: service@repairtw.com

Line id: @zzzz

www.repairtw.com

7.1.5 Starting Torque Compensation Function (for SPEC: F)

Starting torque compensation can be input to speed up the torque command at starting with open-loop vector control.

This function is effective for machinery with large friction loads, cranes, and other applications where starting torque is required. However, this compensation only applies at startup, in contrast to Flux vector control.

■ Starting Torque Compensation Function (C4-03 to C4-05)

User Constant Number	Name	Change during Operation	Setting Range	Unit	Factory Setting	Valid Access Levels	
						Open Loop Vector	Flux Vector
C4-03	Starting torque compensation value (forward direction)		0.0 to 200.0	0.1 %	0.0	A	
C4-04	Starting torque compensation value (reverse direction)		-200.0 to 0.0	0.1 %	0.0	A	
C4-05	Constant for starting torque compensation		0 to 200	1 ms	10	A	

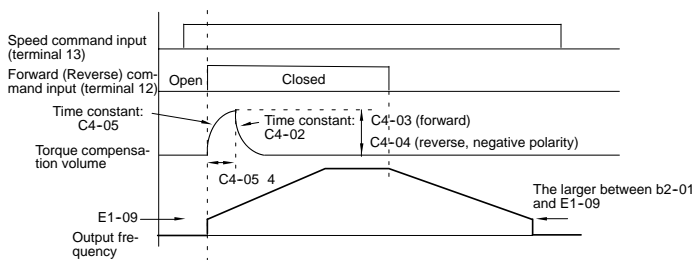

The lower limit of Inverter's torque value is determined by the above torque compensation value.

Fig 7.4 Time Chart for Starting Torque Frequency

- When this function is used, set the starting torque value to the friction load value for ordinary machinery, and to the load for cranes and other lifting devices.
 - Friction load: Set the friction load for both C4-03 and C4-04.
 - Lifting devices: Set the load for the motor side only (hoist). Do not use this function for lifting devices with counterweights as a shock will be generated if there is a regenerative load.
- Compensation can be set only for the motoring side, for both the forward and reverse directions. It cannot be set for the regenerative side.
- Starting torque compensation is disabled when switching between forward and reverse after conducting a speed search.
- Starting torque compensation is always disabled when the second motor is used.

www.repairtw.com

7.2 Flux Vector Control

The functions that can be used with flux vector control are listed in *Table 7.2*. Details on functions that are specific to flux vector control (i.e. those marked with a) are provided in the following table.

Table 7.2 Flux Vector Control Functions

Group	Function	Comments	Control Method	
			Open Loop Vector	Flux Vector
b Application	b1 Sequence	Settings such as the reference input method		
	b2 DC Injection Braking	DC injection braking function settings		
	b3 Speed Search	Speed search function settings		
C Tuning	C1 Accel/Decel	Acceleration/deceleration time settings		
	C2 S-Curve Acc/Dec	S-curve characteristics for accel/decel times		
	C3 Motor-Slip Compensation	Motor temperature compensation function adjustment		
	C4 Torque Compensation	Not used. (Can't be set.)		
	C5 Speed Controls	Speed control loop adjustment		
	C6 Carrier Frequency	Carrier frequency settings		
	C8 Factory Tuning	Not used. (Can't be set.)		
	d Reference	d1 Preset Reference	Frequency reference settings (when using Operator)	
d2 Reference Limits		Frequency upper and lower limit settings		
d3 Jump Frequencies		Prohibited frequency settings		
d4 Reference frequency hold function		Up/Down, Accel/Decel stop hold frequency setting		
E Motor	E1 V/f Pattern	Motor constant settings (Motor constants set automatically with autotuning.)		
	E2 Motor Setup			
	E3 Motor 2 Control Methods	Control method settings for motor 2.		
	E4 Motor 2 V/f Characteristics	V/f characteristics settings for motor 2.		
	E5 Motor 2 Motor Constants	Motor constant settings for motor 2.		
F Options	F1 PG Speed Control Card Settings	Constant settings for a PG Speed Control Card		
	F2 Analog Reference Card AI	User constant settings for an Analog Reference Card		
	F3 Digital Reference Card DI	User constant settings for a Digital Reference Card		
	F4 Analog Monitor Card AO	User constant settings for an Analog Monitor Card		
	F5 Digital Output Card DO	User constant settings for a Digital Output Card		
	F6 Digital Output Card DO	User constant settings for a Digital Output Card		
	F7 Pulse Monitor Card PO	User constant settings for a Pulse Monitor Card		
	F8 SI-F/SI-G Transmission Card	User constant settings for a Transmission Card		
	F9 CP-916B Transmission Card	User constant settings for a Transmission Card		
H Terminal	H1 Multi-function Inputs	Function selection for multi-function inputs		
	H2 Multi-function Outputs	Function selection for multi-function outputs		
	H3 Analog Inputs	Function selection for analog inputs		
	H4 Multi-function Analog Outputs	Function selection for analog outputs		
	H5 MEMOBUS Communications	MEMOBUS communications settings		
L Protection	L1 Motor Overload	Sets electrical/thermal functions that protect the motor		
	L2 Power Loss Ridethru	Selects the power-loss processing method.		
	L3 Stall Prevention	Accel/Decel stall prevention settings and selection		
	L4 Reference Detection	Frequency detection settings and selection		
	L5 Fault Restart	Fault restart function settings		
	L6 Torque Detection	Sets overtorque detection functions 1 and 2 (by current)		
	L7 Torque Limit	Torque limit function settings		
	L8 Hardware Protection	Hardware overheating and open-phase protection settings		
o Operator	o1 Monitor Select	Selects the Operator's display and setting methods.		
	o2 Key Selections	Operator's key function selection and other constants		

7.2.1 Torque Limit Function

With flux vector control, the torque limit can be applied at an arbitrary value because the torque output by the motor is calculated internally. The torque limit function is useful when the load cannot sustain a torque above a certain level or regenerative torque above a certain level.

The two ways to apply a torque limit are listed below.

- Setting torque limits with the constants
- Limiting torque with the analog inputs

The lower torque limit will be used if both of these methods are set. The accuracy of the torque limit is $\pm 5\%$ at all frequencies.

■ Setting a Torque Limit with Constants: L7-01 to L7-04

- Torque limits can be set separately for the 4 ways that torque can be applied: forward torque, reverse torque, forward regenerative torque, and reverse forward regenerative torque.

User Constant Number	Name	Change during Operation	Setting Range	Unit	Factory Setting	Valid Access Levels	
						Open Loop Vector	Flux Vector
L7-01	Forward torque limit		0 to 300	%	200	B	B
L7-02	Reverse torque limit		0 to 300	%	200	B	B
L7-03	Forward regenerative torque limit		0 to 300	%	200	B	B
L7-04	Reverse regenerative torque limit		0 to 300	%	200	B	B

- Figure 7.5 shows the relationship between each constant and the output torque.

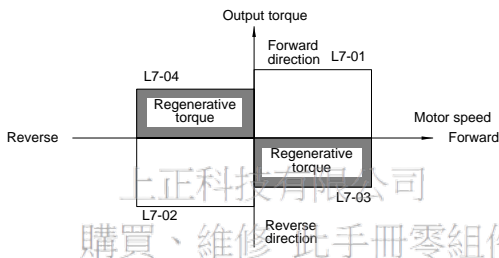

Fig 7.5 Torque Limit Function

- When the torque limit function is used, the torque control has priority and motor speed control and compensation will be disregarded, so the acceleration/deceleration times might be lengthened and motor speed might be reduced.

■ Limiting Torque with Analog Inputs: H3-05, H3-09

The following two analog inputs that can be used to limit torque. Use either or both of these inputs as needed with constants H3-05 and H3-09.

- Multi-function analog input terminal 16
- Frequency reference (current) terminal 14

User Constant Number	Name	Change during Operation	Setting Range	Unit	Factory Setting	Valid Access Levels	
						Open Loop Vector	Flux Vector
H3-05	Multi-function analog input (terminal 16)		0 to 1F	-	0	B	B
H3-09	Multi-function analog input (terminal 14)		1 to 1F	-	1F	A	A

- Settings

Setting	Name
10	Forward Torque Limit
11	Reverse Torque Limit
12	Regenerative Torque Limit
13	Torque reference (The input limits torque in both the forward and reverse directions during speed control.)
15	Forward/Reverse Torque Limit (Limits torque in both the forward and reverse directions.)

- The above table shows only those settings related to the torque limit function.
- Set the analog input terminal's signal level, gain, and bias to match the actual input signal.
- The factory default settings for the input terminal's signal level are as follows:
 - Terminal 16: 0 to +10 V (A 10 V input limits the torque to 100% of the motor's rated torque.)
 - Terminal 14: 4 to 20 mA (A 20 mA input limits the torque to 100% of the motor's rated torque.)

Figure 7.6 shows the relationship between the output torque and each torque limit.

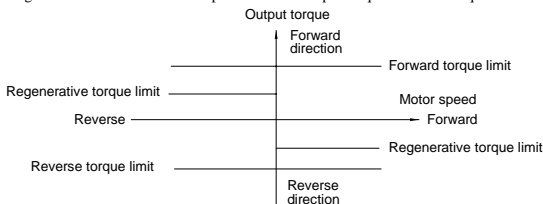

Fig 7.6 Limiting Torque via Analog Inputs

- When the forward torque limit has been set, the analog input signal acts as the limit value for torque generated in the forward direction. The torque limit input is effective when torque is generated in the forward direction even if the motor is operating in reverse (regenerative torque).
- The torque limit is 100% of the motor's rated torque when the analog input is at its maximum value (10 V or 20 mA). To increase the torque limit above 100%, set the input terminal's gain above 100%. For example, a gain of 150.0% would result in a torque limit of 150% of the motor's rated torque with a 10 V or 20 mA analog input.

7.2.2 Setting/Adjusting Motor Constants

■ Adjusting the V/f Pattern: E1-04 to E1-06, E1-09, E1-13

- Normally, it isn't necessary to adjust the V/f pattern with flux vector control. Adjust the V/f pattern when you want to change the maximum output frequency, maximum voltage, base frequency, or minimum output frequency settings.

User Constant Number	Name	Change during Operation	Setting Range	Unit	Factory Setting	Valid Access Levels	
						Open Loop Vector	Flux Vector
E1-04	Max. output frequency		40.0 to 400.0	Hz	60.0	Q	Q
E1-05	Max. voltage		0.0 to 255.0 ^{*1}	VAC	200.0 ^{*1}	Q	Q
E1-06	Base frequency		0.0 to 400.0	Hz	60.0	Q	Q
E1-09	Min. output frequency		0.0 to 400.0	Hz	0.0	Q	A
E1-13	Base voltage		0.0 to 255.0	VAC	0.0 ^{*2}	Q	Q

*1. These voltages are for the 200 V class; Double the voltage for 400 V class Inverters.

*2. If E1-13 is set to 0.0, the same value as in E1-13 will be set for E1-05. It does not normally need to be set separately.

Note 1. The default setting for E1-09 depends on the control method. The default settings shown in the table are for flux vector control.

- The three frequency settings must satisfy the following equation:

$$E1-04 (F_{MAX}) \geq E1-06 (F_A) > E1-09 (F_{MIN})$$

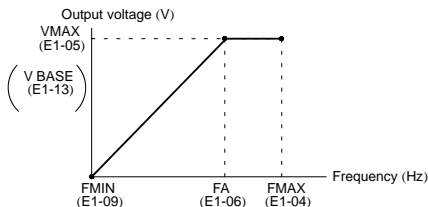

Fig 7.7 V/f Pattern Adjustment

Units for V/f Pattern Settings: o1-04

The units used for V/f pattern frequency settings can be changed when flux vector control has been selected.

User Constant Number	Name	Change during Operation	Setting Range	Unit	Factory Setting	Valid Access Levels	
						Open Loop Vector	Flux Vector
o1-04	Frequency units of constant setting		0 1	-	0		B

- Display Unit Settings

Setting	Function
0	Units: Hz
1	Units: r/min

- The setting units for constants E1-04, E1-06, and E1-09 can be changed.
- The unit for other frequencies will not change.
- Constant o1-04 is specific to flux vector control.

Setting Motor Constants: E2-01 to E2-09

The motor constants (function E2) will all be set automatically when autotuning is performed. Set these constants manually if autotuning can't be completed properly.

Motor Rated Current: E2-01

User Constant Number	Name	Change during Operation	Setting Range	Unit	Factory Setting	Valid Access Levels	
						Open Loop Vector	Flux Vector
E2-01	Motor rated current		0.32 to 6.40	A	1.90	Q	Q

- The setting range is 10% to 200% of the Inverter rated output current. The default setting depends upon the Inverter capacity. (The table shows the default setting for 200 V class, 0.4 kW Inverters.) See page NO TAG.)
- Set the rated current (A) shown on the motor nameplate.

Motor Rated Slip: E2-02

User Constant Number	Name	Change during Operation	Setting Range	Unit	Factory Setting	Valid Access Levels	
						Open Loop Vector	Flux Vector
E2-02	Motor rated slip		0.00 to 20.00	Hz	2.90	Q	Q

- The default setting depends upon the Inverter capacity. (The table shows the default settings for 200 V class, 0.4 kW Inverters.) (See page NO TAG.)
- Calculate the rated slip (E2-02) from the value shown on the motor nameplate with the following equation and set this value.

$$\text{Rated slip} = \text{rated frequency (Hz)} - \text{rated speed (r/min)} \times \text{number of poles}/120$$

Motor No-load Current: E2-03

User Constant Number	Name	Change during Operation	Setting Range	Unit	Factory Setting	Valid Access Levels	
						Open Loop Vector	Flux Vector
E2-03	Motor no-load current		0.00 to 1500.0	A	1.20	Q	Q

- The default setting depends upon the Inverter capacity.
(The table shows the default settings for 200 V class, 0.4 kW Inverters.) (See page NO TAG.)
- Set the no-load current (E2-03) at the rated voltage and rated frequency. Normally this value isn't shown on the motor nameplate, so it might be necessary to contact the motor manufacturer.

Number of Motor Poles: E2-04

User Constant Number	Name	Change during Operation	Setting Range	Unit	Factory Setting	Valid Access Levels	
						Open Loop Vector	Flux Vector
E2-04	Number of motor poles		2 to 48	-	4		Q

- Set the number of poles (E2-04) shown on the motor nameplate.

Motor Line-to-line Resistance: E2-05

User Constant Number	Name	Change during Operation	Setting Range	Unit	Factory Setting	Valid Access Levels	
						Open Loop Vector	Flux Vector
E2-05	Motor line-to-line resistance		0.000 to 65.000		9.842	A	A

- The default setting depends upon the Inverter capacity.
(The table shows the default settings for 200 V class, 0.4 kW Inverters.) (See page NO TAG.)
- Set the motor terminal resistance (U-V, V-W, and W-U) in constant E2-05.
- Normally this value isn't shown on the motor nameplate, so it might be necessary to contact the motor manufacturer for the terminal resistance at the insulation class temperature. Use the following equations to calculate the resistance value from the terminal resistance of a test report.
 - E-class insulation: Terminal resistance at 75°C in the test report (Ω) x 0.92
 - B-class insulation: Terminal resistance at 75°C in the test report (Ω) x 0.92
 - F-class insulation: Terminal resistance at 115°C in the test report (Ω) x 0.87

Motor Leak Inductance: E2-06

User Constant Number	Name	Change during Operation	Setting Range	Unit	Factory Setting	Valid Access Levels	
						Open Loop Vector	Flux Vector
E2-06	Motor leak inductance		0.0 to 30.0	%	18.2	A	A

- The default setting depends upon the Inverter capacity.
(The table shows the default settings for 200 V class, 0.4 kW Inverters.) (See page NO TAG.)
- Set the voltage drop (caused by the motor's leakage inductance) as a percentage of the motor's rated voltage in constant E2-06.
- This constant does not normally require setting because the inverter automatically compensates during operation.
- Normally this value isn't shown on the motor nameplate, so it might be necessary to contact the motor manufacturer. It is also acceptable to set the loss (caused by the motor's leakage inductance) as a percentage.

Email: service@repairtw.com

Line id: @zzzz

www.repairtw.com

Motor Iron-core Saturation Coefficients 1, 2: E2-07, E2-08

User Constant Number	Name	Change during Operation	Setting Range	Unit	Factory Setting	Valid Access Levels	
						Open Loop Vector	Flux Vector
E2-07	Motor iron-core saturation coefficient 1		0.00 to 0.50	-	0.50	A	A
E2-08	Motor iron-core saturation coefficient 2		0.00 to 0.75	-	0.75	A	A

- Constants E2-07 and E2-08 are not required when using the motor at or below the rated frequency.
- Set these constants when operating at a frequency higher than the motor's rated frequency. Set the following values:
 - Motor iron-core saturation coefficient 1: Iron-core saturation coefficient when magnetic flux is 50%.
 - Motor iron-core saturation coefficient 2: Iron-core saturation coefficient when magnetic flux is 75%.
- Normally these values aren't shown on the motor nameplate, so it might be necessary to contact the motor manufacturer. Operation will be possible with the factory-preset values.

Motor Mechanical Loss: E2-09

User Constant Number	Name	Change during Operation	Setting Range	Unit	Factory Setting	Valid Access Levels	
						Open Loop Vector	Flux Vector
E2-09	Motor mechanical loss		0.0 to 10.0	%	0.0		A

- Normally it isn't necessary to change this setting in the following cases:
 - There is a large torque loss to the motor's bearings
 - There is a large torque loss to a fan or pump
- Set the mechanical loss as a percentage of the motor's rated output power (W). Constant E2-09 is used to compensate for torque lost mechanically in the motor.

■ Setting the Slip Compensation Gain: C3-01

User Constant Number	Name	Change during Operation	Setting Range	Unit	Factory Setting	Valid Access Levels	
						Open Loop Vector	Flux Vector
C3-01	Slip compensation gain		0.0 to 2.5	Multiple	1.0	B	B

- Normally it isn't necessary to change this setting.
- With flux vector control, constant C3-01 sets the motor's temperature compensation gain. Adjust the setting when a torque limit or torque control is being used and the output torque varies with the ambient temperature.

電話： 037-466333

Email: service@repairtw.com

Line id: @zzzz

www.repairtw.com

7.2.3 Operation Selection when Output Voltage Saturated

The Inverter cannot output a voltage that is higher than the input voltage. If the output voltage command to the motor (monitor constant U1-06) exceeds the input voltage in the high-speed region, the output voltage becomes saturated, and precise torque control is not longer possible during flux vector control.

Select one of the following methods to insure precise torque control.

■ Limited Output Voltage Operation: C3-06

User Constant Number	Name	Change during Operation	Setting Range	Unit	Factory Setting	Valid Access Levels	
						Open Loop Vector	Flux Vector
C3-06	Limited output voltage operation		0 1	1	0	A	A

• Settings

Setting	Function
0	Disables limited output voltage operation.
1	Enables limited output voltage operation.

- If the limited output voltage operation is disabled and output voltage becomes saturated, the output current does not change. However, torque control precision is no longer possible. Enable limited output voltage operation if precise torque control is required.
- If the limited output voltage operation is enabled, the magnetic flux current of the motor is automatically controlled, and the output voltage command itself is limited, which maintains precise torque control. Check the Inverter current margins as the output current will be maximum 10% higher (with a rated load) than when limited output voltage operation is disabled.

Note 1. C3-06 does not need to be changed if the Unit is used only at medium or low speeds, or when the power supply voltage is 10% more higher than the rated voltage for the motor, or when torque control precision in the high-speed region is not required.

2. When the power supply voltage is too low for the rated motor voltage, precise torque control will not be maintained even if limited output voltage operation is enabled.

上正科技有限公司

購買、維修 此手冊零組件

電話： 037-466333

Email: service@repairtw.com

Line id: @zzzz

www.repairtw.com

7.3 Common Functions

The functions that can be used for all control methods are listed in *Table 7.3*. Details on functions marked with a are provided in the following table.

Table 7.3 Functions Used with All Control Methods

Group	Function	Comments	Control Method	
			Open Loop Vector	Flux Vector
b Application	b1 Sequence	Settings such as the reference input method		
	b2 DC Injection Braking	DC injection braking function settings		
	b3 Speed Search	Speed search function settings		
C Tuning	C1 Accel/Decel	Acceleration/deceleration time settings		
	C2 S-Curve Acc/Dec	S-curve characteristics for acceleration/deceleration times		
	C3 Motor-Slip Compensation	Slip compensation function settings		
	C4 Torque Compensation	Torque compensation function settings		
	C5 Speed Controls	Speed control tuning		
	C6 Carrier Frequency	Carrier frequency settings		
	C8 Factory Tuning	Adjustment for open-loop vector control		
	d Reference	d1 Preset Reference	Frequency reference settings (when using Operator)	
d2 Reference Limits		Frequency upper and lower limit settings		
d3 Prohibited Frequencies		Prohibited frequency settings		
d4 Reference Frequency Hold Functions		Up/Down, Accel/Decel stop hold frequency setting		
E Motor	E1 V/f Pattern	Motor constant settings		
	E2 Motor Setup			
	E3 Motor 2 Control Methods	Control method settings for motor 2.		
	E4 Motor 2 V/f Characteristics	V/f characteristics settings for motor 2.		
	E5 Motor 2 Motor Constants	Motor constant setting for motor 2.		
F Options	F1 PG Speed Control Card Settings	Constant settings for a PG Speed Control Card		
	F2 Analog Reference Card AI	User constant settings for an Analog Reference Card		
	F3 Digital Reference Card DI	User constant settings for a Digital Reference Card		
	F4 Analog Monitor Card AO	User constant settings for an Analog Monitor Card		
	F5 Digital Output Card DO	User constant settings for a Digital Output Card		
	F6 Digital Output Card DO	User constant settings for a Digital Output Card		
	F7 Pulse Monitor Card PO	User constant settings for a Pulse Monitor Card		
	F8 SI-F/SI-G Transmission Card	User constant settings for a Transmission Card		
	F9 CP-916B Transmission Card	User constant settings for a Transmission Card		
H Terminal	H1 Multi-function Inputs	Function selection for multi-function inputs		
	H2 Multi-function Outputs	Function selection for multi-function outputs		
	H3 Analog Inputs	Function selection for analog inputs		
	H4 Multi-function Analog Outputs	Function selection for analog outputs		
	H5 MEMOBUS Communications	MEMOBUS communications settings	-	-
L Protection	L1 Motor Overload	Sets electrical/thermal functions that protect the motor.		
	L2 Power Loss Rldethru	Selects the power-loss processing method.		
	L3 Stall Prevention	Accel/Decel stall prevention settings and selection		
	L4 Reference Detection	Frequency detection settings and selection		
	L5 Fault Restart	Fault restart function settings		
	L6 Torque Detection	Sets overtorque detection functions 1 and 2		
	L7 Torque Limit	Torque limit settings		
	L8 Hardware Protection	Hardware overheating and open-phase protection settings		
o Operator	o1 Monitor Select	Selects the Operator display and setting methods.		
	o2 Key Selections	Operator key function selection and other constants		

7.3.1 Application Constants: b

■ DC Injection Braking: b2-01 to b2-04

- The DC injection braking function decelerates by applying a DC current to the motor. This happens in the following two cases
 - DC Injection Braking Time at Start: Effective for temporarily stopping and then restarting, without regenerative processing, a motor coasting by inertia.
 - DC Injection Braking Time at Stop: Used to prevent coasting by inertia when the motor is not completely stopped by normal deceleration when there is a large load. The stopping time can be shortened by lengthening the DC injection braking time or increasing the DC injection braking current.

User Constant Number	Name	Change during Operation	Setting Range	Unit	Factory Setting	Valid Access Levels	
						Open Loop Vector	Flux Vector
b2-01	Zero speed level (DC injection braking starting frequency)		0.0 to 10.0	Hz	0.5	B	B
b2-02	DC injection braking current		0 to 100	%	50	B	
b2-03	DC injection braking time at start		0.00 to 10.00	s	0.00	B	B
b2-04	DC injection braking time at stop		0.00 to 10.00	s	0.50	B	B

- For the zero speed level (b2-01), set the frequency for beginning DC injection braking for deceleration. If the excitation level is lower than the minimum output frequency (E1-09), the DC injection braking will begin from the minimum output frequency.
- In flux vector control mode, DC injection braking becomes the initial excitation starting frequency at the time of deceleration. In that case, braking starts from the excitation level regardless of the minimum output frequency setting.
- The excitation level is also used as the operating frequency for the zero servo function (for flux vector control only).
- For the DC injection braking current (b2-02), set the value for the current that is output at the time of DC injection braking. DC injection braking current is set as a percentage of Inverter rated output current, with the Inverter rated output current taken as 100%.
- For the DC injection braking time at start (b2-03), set the DC injection braking operating time for when the motor is started.
- For the DC injection braking time at stop (b2-04), set the DC injection braking operating time for when the motor is stopped.
- Figure 7.8 provides a timing chart of DC injection braking (initial excitation).



Fig 7.8 DC Injection Braking Timing Chart

■ Magnetic Flux Compensation: b2-08 (for SPEC: F)

When the DC injection braking time at start (initial excitation) function is used to start the motor magnetic flux before operating machinery requiring high starting torque, particularly with large-capacity motors, the startup of the magnetic flux may take some time due to the effect of the electrical time constants of the motor.

Use the magnetic flux compensation function to supply a strong magnetic flux current when starting the DC injection braking time at start (initial excitation). This will increase the speed and stability of the motor's internal magnetic flux startup.

User Constant Number	Name	Change during Operation	Setting Range	Unit	Factory Setting	Valid Access Levels	
						Open Loop Vector	Flux Vector
b2-03	DC injection braking time at start		0.00 to 10.00	0.01 s	0.00	B	B
b2-08	Magnetic flux compensation volume		0 to 500*	1%	0	A	A

When b2-08 is 100%, it indicates the motor no-load current (motor magnetic flux current).

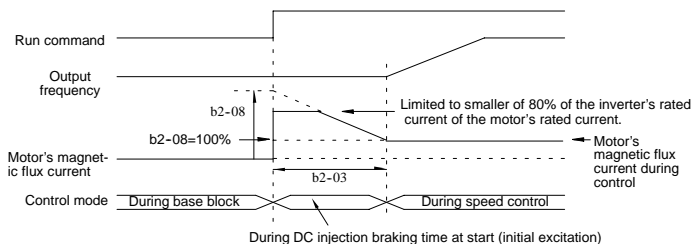

Fig 7.9 Time Chart for Magnetic Flux Compensation

- If b2-08 is set at 100% or greater, a stronger current can be supplied when starting DC injection braking time at start (initial excitation), and the motor's internal magnetic flux startup can be speeded up. The startup time can be reduced by approximately half when the b2-08 is set to 200%.
- The magnetic flux startup is slower if b2-08 is less than 100%. (Do not normally set b2-08 to less than 100%. However, the operation will be the same as b2-08 = 100% when b2-08 = 0%, and the startup will be at the set DC injection braking current (b2-02).)
- If the magnetic flux compensation volume (b2-08) is set to a large value, there may be greater noise generated from the motor during DC injection braking time at start.
- The electrical time constant when the motor's magnetic flux is started (secondary circuit time constant) can be calculated using the motor constant E2 setting and the following formula:
Secondary circuit time constant $T_2 \neq [E2 \cdot 0.1^2 + E2 \cdot 0.3^3] / (2 \times E2 \cdot 0.2 \times E2 \cdot 0.3)$ (sec)
- Do not use this function when slow commencement of braking due to DC injection braking time at start (initial excitation) is becoming a problem. Use the separate DC braking command (setting: 60) for multi-function contact input and start the motor magnetic flux beforehand while stopping the motor.

Line id: @zzzz

www.repairtw.com

■ Speed Search: b3-01 to b3-03

The speed search function finds the speed of a coasting motor and starts up smoothly from that speed. It is effective in situations such as switching from a commercial power supply.

Speed Search Selection at Start: b3-01

User Constant Number	Name	Change during Operation	Setting Range	Unit	Factory Setting	Valid Access Levels	
						Open Loop Vector	Flux Vector
b3-01	Speed search selection at start		0 1	-	0 *	A	A

* When the control method is switched, the factory setting changes as follows:
open-loop vector 0; flux vector: 1

• Settings

Setting	Contents	
0	Speed search disabled:	Motor starts from minimum output frequency.
1	Speed search enabled:	Speed search is performed from maximum output frequency and motor is started. (In control methods with PG, i.e., V/f with PG feedback and flux vector, motor starts from the motor speed.)

- Set "1" to use the speed search function. A speed search is performed each time the run command is input.
- To use speed search freely in control methods without PG, i.e., V/f control and open-loop vector control, set the multi-function contact input selection (H1-01 to H1-06) to 61 or 62 (external search command). (See para 7.3.5.)

Speed Search Operating Current, Speed Search Deceleration Time, and Min. Baseblock Time: b3-02, b3-03, L2-03

User Constant Number	Name	Change during Operation	Setting Range	Unit	Factory Setting	Valid Access Levels	
						Open Loop Vector	Flux Vector
b3-02	Speed search operating current		0 200	%	100	A	
b3-03	Speed search deceleration time		0.1 10.0	s	2.0	A	
L2-03	Min. baseblock time		0.0 0.5	s	0.5 *	B	B

* The factory setting varies depending on the Inverter capacity. The values shown in the table are for 200 V class Inverters of 0.4 kW.

- For the speed search operating current (b3-02), set the operating current for the speed search. If restarting is not possible with the setting, then lower the setting.
- Set the speed search operating current as a percentage of the Inverter's rated output current, with the Inverter's rated output current taken as 100%.
- For the speed search deceleration time (b3-03), set the output frequency deceleration time for while the speed search is being performed. Set the time required to decelerate from the maximum output frequency to 0 Hz.
- Speed search deceleration (b3-03) can be used for the Speed search-after winding change.
- When the speed search and DC injection braking are set, set the minimum baseblock time (L2-03). For the minimum baseblock time, set the time to wait for the motor's residual voltage to dissipate. If an overcurrent is detected when starting a speed search or DC injection braking, raise the setting to prevent a fault from occurring.

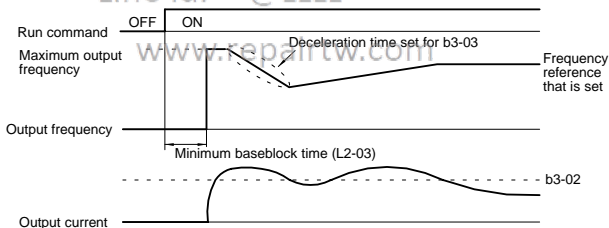

Fig 7.10 Speed Search Timing Chart

7.3.2 Tuning Constants: C

■ S-curve Characteristic Function: C2-01 to C2-04

- Using the S-curve characteristic function for acceleration and deceleration can reduce shock to the machinery when stopping and starting.
- With the Inverter, S-curve characteristic times can be set respectively for beginning acceleration, ending acceleration, beginning deceleration, and ending deceleration.

User Constant Number	Name	Change during Operation	Setting Range	Unit	Factory Setting	Valid Access Levels	
						Open Loop Vector	Flux Vector
C2-01	S-curve characteristic time at acceleration start		0.00 to 2.50	s	0.20	A	A
C2-02	S-curve characteristic time at acceleration end		0.00 to 2.50	s	0.20	A	A
C2-03	S-curve characteristic time at deceleration start		0.00 to 2.50	s	0.20	A	A
C2-04	S-curve characteristic time at deceleration end		0.00 to 2.50	s	0.00	A	A

- The relation between these constants is shown in *Figure 7.11*.

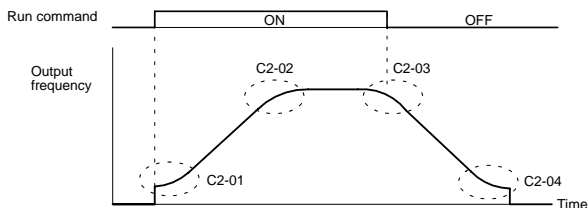

Fig 7.11 Setting S-curve Characteristics

- When the S-curve characteristic time is set, the acceleration and deceleration times will be lengthened as follows:
 - Acceleration time = Selected acceleration time + (S-curve at beginning of acceleration + S-curve at end of acceleration) / 2
 - Deceleration time = Selected deceleration time + (S-curve at beginning of deceleration + S-curve at end of deceleration) / 2

電話： 037-466333

Email: service@repairtw.com

Line id: @zzzz

www.repairtw.com

■ Motor Slip Compensation: C3-01 to C3-04

- The motor slip compensation function calculates the motor torque according to the output current, and sets gain to compensate for output frequency.
 - This function is used to improve speed accuracy when operating with a load.

Slip Compensation Gain: C3-01

User Constant Number	Name	Change during Operation	Setting Range	Unit	Factory Setting	Valid Access Levels	
						Open Loop Vector	Flux Vector
C3-01	Slip compensation gain		0.0 to 2.5	Multiple	1.0 *	B	B

* When the control method is switched, the factory setting changes as follows:
open-loop vector 0; flux vector: 1.0

- When "1.0" is set, this function compensates for the rated slip that has been set, by the rated torque output.
- With flux vector control, this becomes the gain to compensate for slip caused by motor temperature variation. (Refer to *Slip Compensation Gain: C3-01* under 7.2.2.)

Motor Slip Compensation Gain Adjustment Procedure

- Correctly set the motor rated slip (constant E2-02) and the motor no-load current (constant E2-03).
 - The motor rated slip can be calculated by means of the following equation, using the numbers that are shown on the motor nameplate.
Motor rated slip =
Motor rated frequency (Hz) - rated speed (r/min) x motor (No. of poles) / 120
 - Set the values at the rated voltage and rated frequency for the motor no-load current. With vector control, the motor rated slip is automatically set by autotuning.
- Set the slip compensation gain (constant C3-01 to "1.0." (If it is set to "0.0," slip compensation will be disabled.)
- Operate with a load, measure the speed, and adjust the slip compensation gain (in increments of 0.1).
 - If the speed is lower than the target value, increase the slip compensation gain.
 - If the speed is higher than the target value, decrease the slip compensation gain.

Slip Compensation Primary Delay Time: C3-02

User Constant Number	Name	Change during Operation	Setting Range	Unit	Factory Setting	Valid Access Levels	
						Open Loop Vector	Flux Vector
C3-02	Slip compensation primary delay time		0 to 10000	ms	200	A	

- This constant does not normally need to be set. Adjust the slip compensation primary delay time if the motor slip compensation responsiveness is low, or if the speeds are unstable.
 - If responsiveness is low, lower the setting.
 - If speeds are unstable, raise the setting.

Slip Compensation Limit: C3-03

User Constant Number	Name	Change during Operation	Setting Range	Unit	Factory Setting	Valid Access Levels	
						Open Loop Vector	Flux Vector
C3-03	Slip compensation limit		0 to 250	%	200	A	

- Constant C3-03 sets the slip compensation limit as a percentage of motor rated slip (E2-02), with the motor rated slip taken as 100%.
- If the speed is lower than the target value and does not change even when the slip compensation gain is adjusted, it is possible that the slip compensation limit has been reached. Raise the limit and then check again. Make sure, however, that the value of the sum of the reference frequency and the slip compensation limit does not exceed the speed capacity of the machinery.
- The limit is as shown in Figure 7.12 in the constant torque and constant output areas.

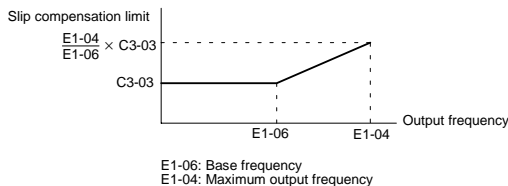

Fig 7.12 Slip Compensation Limit

Slip Compensation Selection During Regeneration: C3-04

User Constant Number	Name	Change during Operation	Setting Range	Unit	Factory Setting	Valid Access Levels	
						Open Loop Vector	Flux Vector
C3-04	Slip compensation selection during regeneration		0 1	-	0	A	

• Settings

Setting	Contents
0	Slip compensation disabled during regeneration
1	Slip compensation enabled during regeneration

- Constant C3-04 enables or disables slip compensation during regeneration.
- The amount of regeneration is momentarily increased when this function is used, so some control option (e.g., Braking resistor, Braking Resistor Unit, Braking Unit) may be required.

■ Torque Compensation Function: C4-01, C4-02

The torque compensation function detects increases in the motor load, and increases the output torque to compensate.

Torque Compensation Gain: C4-01

User Constant Number	Name	Change during Operation	Setting Range	Unit	Factory Setting	Valid Access Levels	
						Open Loop Vector	Flux Vector
C4-01	Torque compensation gain		0.00 to 2.50	Multiple	1.00	B	

- This constant can be changed during operation, but normally no adjustments are required.
- Set the torque compensation gain so that the output current at low-speed rotation does not exceed 50% of the Inverter's rated output current.
- Do not adjust the setting of this constant for open-loop vector control.

Torque Compensation Time Constant: C4-02

User Constant Number	Name	Change during Operation	Setting Range	Unit	Factory Setting	Valid Access Levels	
						Open Loop Vector	Flux Vector
C4-02	Torque compensation time constant		0 to 10000	ms	20	A	

- The torque compensation time constant does not normally need to be adjusted, but make adjustments in the following cases:
 - If the motor generates excessive oscillation, raise the setting.
 - If motor responsiveness is low, lower the setting.

■ Prohibited Frequencies (Jump Frequencies): d3-01 to d3-04

- This function allows the prohibition or “jumping” of certain frequencies within the Inverter’s output frequency range so that the motor can operate without resonant oscillations caused by some machine systems.
- It is also used for deadband control.

User Constant Number	Name	Change during Operation	Setting Range	Unit	Factory Setting	Valid Access Levels	
						Open Loop Vector	Flux Vector
d3-01	Jump frequency 1		0.0 to 400.0	Hz	0.0	B	B
d3-02	Jump frequency 2		0.0 to 400.0	Hz	0.0	B	B
d3-03	Jump frequency 3		0.0 to 400.0	Hz	0.0	B	B
d3-04	Jump frequency width		0.0 to 20.0	Hz	1.0	B	B

- To disable this function, set the jump frequency references (d3-01 to d3-03) to 0.0 Hz.
- For d3-01 to d3-03, set the center values of the frequencies to be jumped. Be sure to set the jump frequency so that $d3-03 \leq d3-02 \leq d3-01$.
- For d3-04, set the jump frequency bandwidth. The jump frequency \pm the jump frequency bandwidth becomes the jump frequency range.
- Operation is prohibited within the jump frequency range, but changes during acceleration and deceleration are smooth with no jumps.
- The relation between the internal frequency reference and the set frequency references is shown in Figure 7.14.

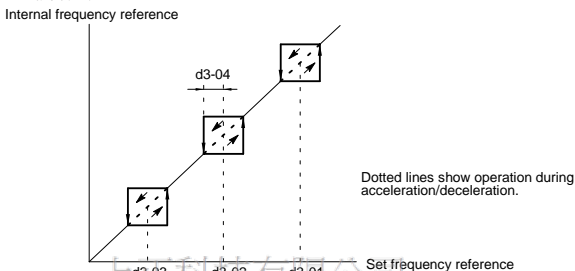

Fig 7.14 Setting Prohibited Frequencies

■ Hold Reference Memory Selection: d4-01

- Constant d4-01 is enabled by making either of the following settings for the multi-function inputs (H1-01 to H1-06):
 - Acceleration/deceleration-ramp hold (setting: A)
 - Up command (setting: 10)/down command (setting: 11)
- When hold status is established by these external signals, specify whether or not the output frequency is to be retained.
- When this function is enabled, operation is re-started after power-up using the frequency reference value that was retained.

User Constant Number	Name	Change during Operation	Setting Range	Unit	Factory Setting	Valid Access Levels	
						Open Loop Vector	Flux Vector
d4-01	Frequency reference hold function selection		0-1		0	A	A

- Settings

Setting	Contents
0	Disabled. Restart after operation stoppage or power-up begins at zero.
1	Enabled. Restart after operation stoppage or power-up begins at the held frequency reference.

- For information regarding the acceleration/deceleration stop (hold) command and the up/down command, refer to the description of *Multi-function Input (H1)*.

■ Trim Control Level: d4-02

- The trim control level is valid when the trim control increase command (setting: 1C) or trim control decrease command (setting: 1D) is set for a multi-function input (H1-01 to H1-06).

- If the trim control increase command is ON when a frequency reference is input on the analog input, the trim control level will be added to the analog frequency reference and then output as the output frequency. If the trim control decrease command is ON, the frequency reference will be decreased by the trim control level.

User Constant Number	Name	Change during Operation	Setting Range	Unit	Factory Setting	Valid Access Levels	
						Open Loop Vector	Flux Vector
d4-02	+- Speed limits		0 to 100	%	25	A	A

- Set the trim control level as a percentage of the maximum output frequency.
- If the frequency reference minus the trim control level is less than zero, the output frequency will be zero.
- Refer to the description of *Multi-function Inputs (HI)* for details on the trim control increase and trim control decrease commands.

7.3.4 Option Constants: F

■ Installing Option Cards

A maximum of three Option Cards can be installed in the Inverter. The installation location of each is determined by the type of Card. Be sure to install the Cards in their correct locations.

Constants of the Option Cards can be referred to or set with the access level Basic.

Table 7.4 Option Card Specifications

Type of card	Model	Specifications	Location
Analog Reference Card	AI-14U	14-bit analog, 2 inputs (voltage/current)	C
	AI-14B	14-bits analog, 3 inputs	C
Digital Reference Card	DI-08	8-bit digital input (BCD/binary)	C
	DI-16H2	16-bit digital input (BCD/binary)	C
PG Speed Control Card	PG-B2	Complementary, A/B-phase input	A
	PG-X2	Line-driver, A/B-phase input	A
Analog Monitor Card	AO-08	8-bit analog output, 2 channels	D
	AO-12	12-bit analog output, 2 channels	D
Pulse Monitor Card	PO-36F	Pulse frequency output	D

Installation Procedure

1. Turn OFF the Inverter's main-circuit power supply. Wait at least one minute (or at least three minutes for models of 30 kW or more).
2. Remove the Inverter's front cover. Check to be sure that the CHARGE LED is turned OFF.
3. Check the Option Card's installation location (A, C, or D). (See *Figure 7.15*.)
4. Insert the accessory spacer into the spacer mounting hole in the Inverter mounting base.
5. Align the Option Card connector with the connector position on the control board, and then pass the spacer to the spacer mounting hole on the card.
Press firmly until the spacer snaps into place.
6. Connect the Option Card's FG connection line to the Inverter ground terminal (terminal 12).

Line id: @zzzz

www.repairtw.com

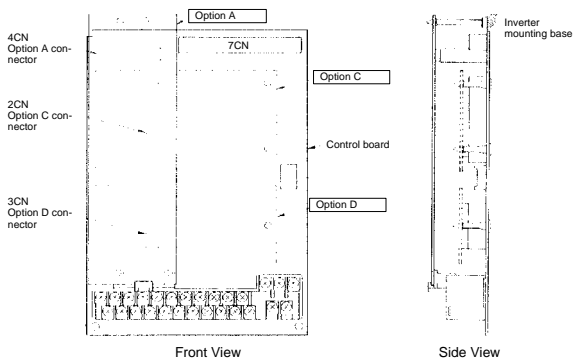

Fig 7.15 Installation Locations for Option Cards

■ Analog Reference Card: F2-01

- When using a AI-14B/A1-14U Analog Reference Card, set constant b1-01 (reference selection) to "3" (option).
- When using a AI-14B, set the function for channels 1 to 3 with constant F2-01. (There are no constants to set for AI-14U.)

User Constant Number	Name	Change during Operation	Setting Range	Unit	Factory Setting	Valid Access Levels	
						Open Loop Vector	Flux Vector
F2-01	Bi-polar or uni-polar input selection		0 1	-	0	B	B

- Settings

Setting	Description
0	3-channel individual input (CH1: terminal 13; CH2: terminal 14; CH3: terminal 16)
1	3-channel additional input (Sum of CH1 to CH3 is used as the frequency reference value.)

- Constant b1-01 (reference selection) must be set to "1" (external terminal), when 3-channel individual input (setting: 0) is set.
- When using a AI-14B and setting 3-channel individual input, the multi-function inputs cannot be set to the Option/Inverter selection function (setting: 2).

Email: service@repairtw.com

Line id: @zzzz

www.repairtw.com

■ Digital Reference Card: F3-01

- When using a DI-08 or DI-16H2 Digital Reference Card, set constant b1-01 (reference selection) to "3" (option) and set the input method with constant F3-01.

User Constant Number	Name	Change during Operation	Setting Range	Unit	Factory Setting	Valid Access Levels	
						Open Loop Vector	Flux Vector
F3-01	Digital input option		0 to 7	-	0	B	B

• Settings

Setting	Description
0	BCD 1% unit
1	BCD 0.1% unit
2	BCD 0.01% unit
3	BCD 1 Hz unit
4	BCD 0.1 Hz unit
5	BCD 0.01 Hz unit
6	BCD special setting (5-digit input) (Only when DI-16H2 is used.)
7	Binary input (Setting is displayed in decimal notation.)

- The maximum frequency (100% speed) reference will be used when the binary input is set (setting: 7) and all bits are "1."
 - DI-08: Maximum output frequency reference (255/100%).
 - DI-16H2: Maximum output frequency reference (16 bits: 30000/100%, 12 bits: 4095/100%).
- Setting 6, BCD special setting (5-digit input), is valid only when the DI-16H2 is used. Using this setting, a frequency from 0.00 to 399.98 Hz can be set in BCD. The data input method is different from that for settings of 1 to 5.

Setting: 1 to 5	Sign	8 10 ³	4 10 ³	2 10 ³	1 10 ³		8 10 ⁰	4 10 ⁰	2 10 ⁰	1 10 ⁰	
Setting: 6		2 10 ⁴	1 10 ⁴	8 10 ³	4 10 ³	2 10 ³		1 10 ¹	8 10 ⁰	4 10 ⁰	2 10 ⁰

- The sign bit is used as a data bit, so only positive (plus) data can be set.
- The second digit below the decimal point is set by bits 8x10⁰, 4x10⁰, and 2x10⁰, so the settings are made in units of 0.02 Hz. (If these three bits are "111," "110," and "101," they will be recognized as "9.")

■ Analog Monitor Card: F4-01 to F4-04

- When using an AO-08 or AO-12 Analog Monitor Card, set the monitor items and gain with the following constants.

User Constant Number	Name	Change during Operation	Setting Range	Unit	Factory Setting	Valid Access Levels	
						Open Loop Vector	Flux Vector
F4-01	Channel 1 monitor selection		1 to 38	-	2	B	B
F4-02	Channel 1 gain		0.00 to 2.50	Multiple	1.00	B	B
F4-03	Channel 2 monitor selection		1 to 38	-	3	B	B
F4-04	Channel 2 gain		0.00 to 2.50	Multiple	0.50	B	B
F4-05	Channel 1 output bias		-10.0 to +10.0	%	0.0	B	B
F4-06	Channel 2 output bias		-10.0 to +10.0	%	0.0	B	B

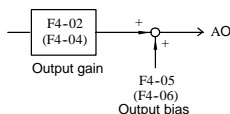

Fig 7.16 Analog Output Block Diagram

- For the output monitor selections (F4-01, F4-03), set the numbers for the right side of the "U1" constants in *Table 4.3*. The setting range is 1 to 38, but the following numbers cannot be set: 4, 10, 11, 12, 13, 14, 25, and 28 to 35.
- When the AO-12 is used, outputs of 0 to ± 10 V are possible. For that, set constant H4-07 (multi-function analog output signal level selection) to "1" (0 to ± 10 V outputs). There are some monitor items. However, that can only use outputs of 0 to +10 V even if constant H4-07 is set to "1."
- When the AO-08 is used, only outputs of 0 to +10 V are possible regardless of the constant H4-07 setting.
- Set the amount of parallel movement by raising or lowering the output characteristics in the output bias.
Use a percentage (%) as the unit of measurement with 10 V equalling 100%.

■ DO-02 Digital Output Card Settings: F5-01 F5-02

- Set the output selections in the following constants when using a DO-02 Digital Output Card.

User Constant Number	Name	Change during Operation	Setting Range	Unit	Factory Setting	Valid Access Levels	
						Open Loop Vector	Flux Vector
F5-01	Channel 1 output selection		00 to 37	-	0	B	B
F5-02	Channel 2 output selection		00 to 37	-	1	B	B

- Set the values from *Table 7.7*.

■ DO-08 Digital Output Card Settings: F6-01

- Set the output mode in the following constants when using a DO-08 Digital Output Card.

User Constant Number	Name	Change during Operation	Setting Range	Unit	Factory Setting	Valid Access Levels	
						Open Loop Vector	Flux Vector
F6-01	Output mode selection		0 1	-	0	B	B

- The items output from the DO-08 will be as follows according to the setting of F6-01.

Setting	Terminal	Output
0: 8 channels of individual outputs	TD5-TD11	Overcurrent SC OC GF
	TD6-TD11	Overvoltage OV
	TD7-TD11	Inverter overload_OL2
	TD8-TD11	Fuse blown PUF
	TD9-TD11	Overspeed OS
	TD10-TD11	Inverter overheat OH1 or motor overload OL1
	TD1-TD2	Zero speed detection
	TD3-TD4	Speed agree
1: Binary code output	TD5-TD11	Bit 0
	TD6-TD11	Bit 1
	TD7-TD11	Bit 2
	TD8-TD11	Bit 3
	TD9-TD11	Zero speed detection
	TD10-TD11	Speed agree
	TD1-TD2	Running
TD3-TD4	Minor fault	

Binary code (see below)

Coded Outputs

Bit 3210	Meaning	Bit 3210	Meaning
0000	No fault	1000	External fault EF
0001	Overcurrent SC OC GF	1001	Controller fault CPF
0010	Overvoltage OV	1010	Motor overload OL1
0011	Inverter overload OL2	1011	Not used
0100	Inverter overheat OH OH1	1100	Power loss UV1 UV2 UV3
0101	Overspeed OS	1101	Excessive speed deviation DEV
0110	Fuse blown PUF	1110	PG disconnected PGO
0111	Braking Resistor Unit over-heat RH Braking Transistor fault RR	1111	Not used.

■ Pulse Monitor Card: F7-01

- When using a PO-36F Pulse Monitor Card, set the output pulse in constant F7-01.

User Constant Number	Name	Change during Operation	Setting Range	Unit	Factory Setting	Valid Access Levels	
						Open Loop Vector	Flux Vector
F7-01	Frequency multiple selection		0 to 4	-	1	B	B

- Settings

Setting	Description
0	1F 1 x Inverter output frequency
1	6F 6 x Inverter output frequency
2	10F 10 x Inverter output frequency
3	12F 12 x Inverter output frequency
4	36F 36 x Inverter output frequency

- "F" indicates the output frequency (Hz). For example, if "0" (1F) is set, when the output frequency is 60 Hz there will be an output of 60 pulses per second. (Duty 50%)

上正科技有限公司

購買、維修 此手冊零組件

電話： 037-466333

Email: service@repairtw.com

Line id: @zzzz

www.repairtw.com

7.3.5 External Terminal Functions: H

This section describes the settings for the external terminal functions.

■ Multi-function Input Settings: H1

The settings and functions for the multi-function inputs are listed in *Table 7.5*.

Table 7.5 Multi-function Input Functions

Setting value	Function	Control Method	
		Open Loop Vector	Flux vector
0	3-wire sequence (Forward/Reverse run command)		
1	Local/Remote selection (ON: Operator, OFF: Constant setting)		
2	Option/Inverter selection (ON: Option card)		
3	Multi-step speed reference 1 When H3-05 is set to "0," this function is combined with "Master/auxiliary speed switch."		
4	Multi-step speed reference 2		
5	Multi-step speed reference 3		
6	Jog frequency reference (higher priority than multi-step speed reference)		
7	Accel/Decel time 1		
8	External baseblock NO (NO contact: Baseblock at ON)		
9	External baseblock NC (NC contact: Baseblock at OFF)		
A	Accel/Decel ramp hold (ON: Accel/decel stopped, frequency on hold)		
B	OH2 alarm signal input (ON: OH2 will be displayed)		
C	Multi-function analog input selection (ON: Enable)		
E	Speed control integral reset (ON: Integral control disabled)		
F	Not used. (Do not input this setting.)		
10	Up command (Always set with the down command)		
11	Down command (Always set with the up command)		
12	FJOG command (ON: Forward run at jog frequency d1-09)		
13	RJOG command (ON: Reverse run at jog frequency d1-09)		
14	Fault reset (Reset when turned ON)		
15	Emergency stop (ON: Deceleration to stop in emergency stop time C1-09)		
16	Motor switch command (Motor 2 selection)		
1A	Accel/Decel time 2		
1B	Constants write enable (ON: All constants can be written-in. OFF: All constants other than frequency monitor are write protected.)		
1C	Trim control increase (ON: d4-02 frequencies are added to analog frequency references.)		
1D	Trim control decrease (ON: d4-02 frequencies are subtracted from analog frequency references.)		
1E	Analog frequency reference simple hold		
1F	Frequency reference terminal 13/14 selection (ON: selects terminal 14)		
20	External fault (Desired settings possible)		
2F	Input mode: NO contact/NC contact, Detection mode: Normal/during operation Stopping method: Deceleration to stop, coast to stop, emergency stop or continue operation.		
60	DC injection braking command (ON: Performs DC injection braking)		
61	External speed search command 1: Maximum output frequency (ON: speed search)		
62	External speed search command 2: Set frequency (ON: speed search)		
64	External speed search command 3		
65	KEB (deceleration at momentary power loss) command (NO contact)		
66	KEB (deceleration at momentary power loss) command (NO contact)		
77	Speed control (ASR) proportional gain switch (ON: C5-03)		

Constant Settings

User Constant Number	Name	Change during Operation	Setting Range	Unit	Factory Setting	Valid Access Levels	
						Open Loop Vector	Flux Vector
H1-01	Multi-function input 1 (terminal 3)		0 to 77	-	24	B	B
H1-02	Multi-function input 2 (terminal 4)		0 to 77	-	14	B	B
H1-03	Multi-function input 3 (terminal 5)		0 to 77	-	3 (0)	B	B
H1-04	Multi-function input 4 (terminal 6)		0 to 77	-	4 (3)	B	B
H1-05	Multi-function input 5 (terminal 7)		0 to 77	-	6 (4)	B	B
H1-06	Multi-function input 5 (terminal 8)		0 to 77	-	8 (6)	B	B

- The factory settings in parentheses are for when the Unit is initialized for 3-wire control.
- The following table shows the settings and section references for some common functions.

Function	Setting	Section
3-wire sequence (forward/reverse run command)	0	6.1.8
Multi-step speed references 1 to 3 and jog frequency reference	3 to 6	6.1.8
Accel/Decel time 1 and 2	7 1A	6.1.8
Emergency stop	15	6.1.8
FJOG/RJOG commands	12 13	6.1.8
Terminal 13/14 switch	1F	6.1.8
Timer function input	18	7.3.1

Local/Remote Selection (Setting: 1)

OFF	Operate with the frequency reference and run command specified in b1-01 (the frequency reference source) and b1-02 (run source).
ON	Operate with the frequency reference and run command set at the Digital Operator.

- With this setting, the multi-function input selects the input method for the frequency reference and run command.
- The input method can be switched only when the Inverter is stopped.
- The Digital Operator LOCAL/REMOTE Key is disabled when this function has been set in a multi-function input.

Option Card/Inverter Selection (Setting: 2)

OFF	The Inverter frequency reference is enabled.
ON	The Option Card frequency reference is enabled.

- With this setting, the multi-function input enables the frequency reference input from the Inverter itself or the one from Option Card. The frequency reference input can be switched only when the Inverter is stopped.
- Be sure that b1-01 (the frequency reference source selector) has been set to 0 (Operator) or 1 (external terminal). Only the frequency reference from the Option Card will be enabled if b1-01 is set to 3 (Option PCB).
- Setting 2 can't be selected if the AI-14B is being used and constant F2-01 (AI-14 Input Selector) is set to 0.

External Baseblock NO (Setting: 8)

OFF	Normal operation
ON	Baseblock

External Baseblock NC (Setting: 9)

OFF	Baseblock
ON	Normal operation

- With either of these settings, the multi-function input controls baseblock operation.
- Baseblock is an interruption of the Inverter output. The motor coasts while the baseblock command is being input.

- The output frequency is retained internally, so the same frequency will be output again when the baseblock command is cleared. The output frequency will change in a step pattern when the output resumes, so take some safety precaution such as turning OFF the run command – especially if the baseblock command was input when the motor was operating at high speed. (When the run command is turned OFF, the internally retained output frequency is reset to zero.)
- After a baseblock command is cleared, the voltage will be restored in the voltage recovery time set in L2-04.

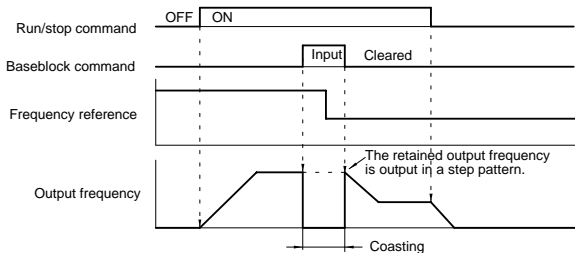

Fig 7.17 Baseblock Command

Acceleration/Deceleration Ramp Hold (Setting: A)

OFF	Normal operation or restart acceleration/deceleration.
ON	Pause acceleration/deceleration and maintain the present frequency.

- With this setting, the multi-function input pauses acceleration or deceleration and maintains (holds) the output frequency.
- Acceleration/deceleration is restarted when the acceleration/deceleration ramp hold input is turned OFF.
- The motor will be stopped if a stop command is input while the acceleration/deceleration ramp hold input is ON.
- When constant d4-01 (the frequency reference hold function selector) is set to 1, the held frequency will be stored in memory. This stored frequency will be retained even after a power loss and the motor will be restarted at this frequency when a run command is input again.

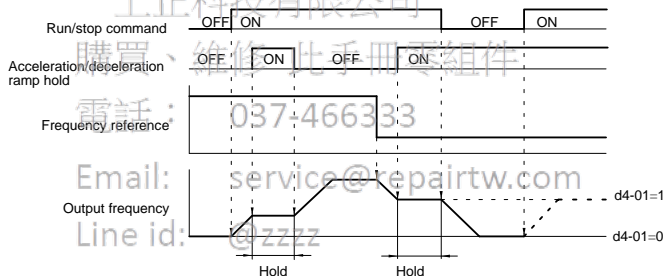

Fig 7.18 Acceleration/Deceleration Ramp Hold

- When d4-01 is set to 1, the held output frequency will be retained. To operate at this frequency even after the Inverter is stopped, input the run command with the acceleration/deceleration ramp hold input ON.
- When d4-01 is set to 0, the output frequency will be held at zero if the run command is input with the acceleration/deceleration ramp hold input ON.

OH2 Alarm Signal (Setting: B)

OFF	Normal operation
ON	Normal operation (The warning message "OH2" will be displayed on the Digital Operator.)

- The message "OH2" will be displayed on the Digital Operator while the multi-function input is ON and the display will revert to its previous status when the input is turned OFF. (It isn't necessary to reset the alarm.) The Inverter will continue operation without detecting a fault.

- With this setting, a temperature sensor can be connected to the multi-function input to display a warning message when the temperature rises too high.

Multi-function Analog Input Selection (Setting: C)

OFF	Disables the multi-function analog input (terminal 16).
ON	Enables the multi-function analog input (terminal 16).

- With this setting, the multi-function input can be used to enable or disable the multi-function analog input.
- Turning the input OFF has the same effect as setting H3-05 (the multi-function analog input selector for terminal 16) to 1F.

Speed Control Integral Reset (Setting: E)

OFF	Operates with PI-control speed control loop.
ON	Operates with P-control speed control loop. (The speed control integral values are reset by the integral time constant.)

- It is possible to switch between these speed control modes during operation.

Up and Down Commands (Settings: 10 and 11)

Up command	ON	OFF	ON	OFF
Down command	OFF	ON	ON	OFF
Operation	Acceleration	Deceleration	Hold	Hold

- With these settings, the multi-function inputs can be used to control the Inverter's output frequency.
- When using this function, be sure to set both the up command (setting 10) and the down command (setting 11) for 2 multi-function inputs. An OPE03 option fault will occur if only one of these commands is set or if an acceleration/deceleration ramp hold input (setting A) is set at the same time.
- Be sure to set constant b1-02 (the run command source selector) to 1 (external terminal). The up/down function won't operate with any other b1-02 setting.
- The frequency up/down commands operate according to the normal acceleration/deceleration times in C1-01 to C1-08.
- The upper and lower limits for the output frequency with the up/down commands are determined by the following settings:
 - Upper limit = Maximum output frequency (E1-04) Reference upper limit (d2-01) 100
 - Lower limit = Maximum output frequency (E1-04) Reference lower limit (d2-02) 100
- When frequency reference (voltage) terminal 13 or frequency reference (current) terminal 14 is being used as a frequency reference input, the greatest frequency value becomes the lower limit.
- When the up/down function is being used, the output frequency will be accelerated to the lower limit if a run command is input.
- When the up/down function and jog frequency reference are both assigned to multi-function inputs, an ON jog frequency reference input has the highest priority.
- Multi-step speed references 1 to 8 are all disabled when the up/down function has been set.
- The output frequency held by the up/down function will be stored in memory if d4-01 (the frequency reference hold function selector) is set to 1. This output frequency will be retained even after a power loss, and operation will be restarted at this frequency the next time that a run command is input. The stored output frequency will be cleared from memory if the up or down command is turned ON while the run command is OFF (see "Reference frequency reset" in Figure 7.19).

Line id: @zzzz

www.repairtw.com

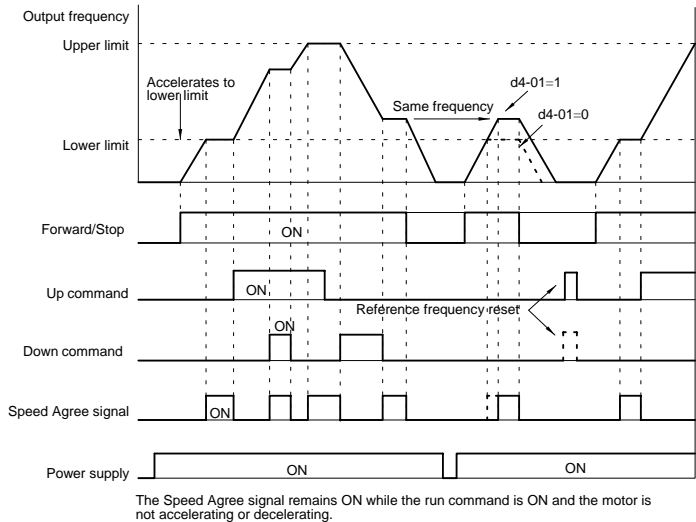

Fig 7.19 Timing Chart for Up and Down Commands

Fault Reset (Setting: 14)

OFF	Normal operation
ON	Resets faults when input goes from OFF to ON. (Normal operation when no fault has occurred.)

- With this setting, the multi-function input resets faults that have occurred.
- When a fault has occurred, be sure to find out what kind of fault occurred, take steps to correct the cause of the fault, and restart the Inverter by repeatedly resetting a fault without correcting the cause.
- To resume operation after a fault has occurred, turn the run command OFF, turn the fault reset input from ON to OFF, and then turn the run command ON again. A fault cannot be reset while the run command is ON.
- If a fault hasn't occurred, turning the fault reset ON and OFF will have no effect on operation.

Motor Switch Command (Motor 2 Selection, Setting: 16)

- CLOSED: Motor 2 constants used

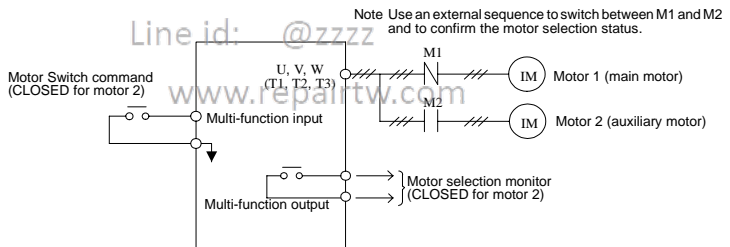

- The control method, V/f characteristics, and motor constants recorded in the Inverter can be switched by setting "16" (motor switch command) for a constant from H1-01 to 06 (multi-function inputs), and then inputting a signal while the motor is stopped.
- The current motor selection can be monitored at a multi-function output terminal by setting "1C" (motor selection monitor) for a constant from H2-01 to 03 (multi-function outputs).
- Set the Basic (3) or Advanced (4) access level in the initialize setting A1-01 (access level).
- The constants being used will be changed as shown in the following table for the motor switch command.

Motor Switch command	OPEN (motor 1)	CLOSED (motor 2)
Control method	A1-02 (control method in initialize settings)	E3-01 (motor 2 control method)
V/f characteristics	E1-04 to 13 (V/f characteristics)	E4-01 to 07 (motor 2 V/f characteristics)
Motor constants	E2-01 to 09 (motor constants)	E5-01 to 06 (motor 2 motor constants)
Motor selection monitor	OPEN	CLOSED

- The timing chart for switching between motor 1 and motor 2 is shown below.

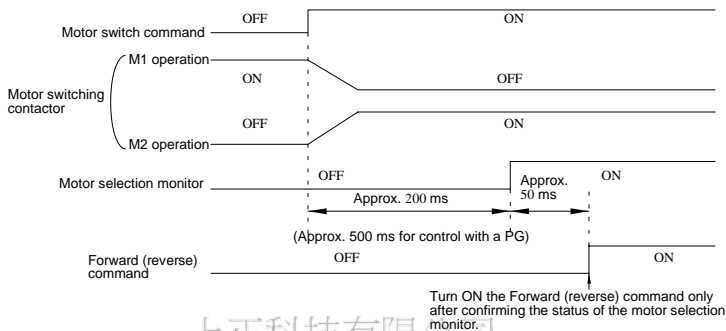

Fig 7.20 Timing Chart for Switching from Motor 1 to Motor 2

Constants Write Enable (Setting: 1B)

OFF	Write-protects all constants except for frequency monitor.
ON	Allows constants specified in Initialize mode to be changed.

- With this setting, the multi-function input can be used to write-protect the Operator constants. When the input is OFF, the Operation mode frequency can be monitored and the frequency can be changed but other changes are prohibited.

Trim Control Increase and Decrease (Settings: 1C and 1D)

Trim Control Increase	ON	OFF	ON	OFF
Trim Control Decrease	OFF	ON	ON	OFF
Output frequency	Reference frequency + trim control level (d4-02)	Reference frequency - trim control level (d4-02)	Reference frequency	Reference frequency

- The trim control increase function adds the level in d4-02 to the analog frequency reference.
- The trim control decrease function subtracts the level in d4-02 to the analog frequency reference.
- These functions are effective when the frequency reference is input from an analog input. These functions must both be set at the same time or an OPE03 fault will occur. The analog frequency reference won't be changed when both the trim control increase and decrease inputs are ON. The output frequency will be zero when the trim control decrease input is ON and the result of the subtraction is less than zero.

Analog Frequency Reference Sample/Hold (Setting: 1E)

- The analog input value will become the frequency reference 100 ms after the multi-function input closes.

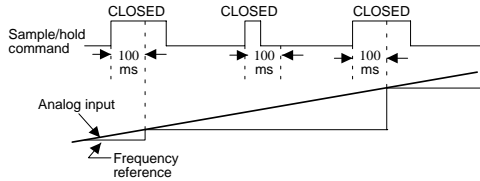

Fig 7.21 Analog Frequency Reference Sample/Hold

- The analog frequency reference sample/hold function is valid only for terminals 13, 14, and 16 or for the analog inputs from the AI-14U or AI-14B.
- An OPE03 fault will occur if two or more of the following signals turn ON at the same time: acceleration/deceleration ramp hold command (0A), up/down commands (10 or 11), trim control increase/decrease commands (1C or 1D), and the analog frequency reference sample/hold command.

External Faults (Settings: 20 to 2F)

- With this setting, the multi-function input can be used to stop the Inverter or output an alarm when a malfunction or fault occurs in a peripheral device.
- There are 16 external fault inputs available with all 16 combinations of the following variables. Select the setting with the desired combination.
 - Input level: Normally open or normally closed
 - Detection method: Always or During operation only
 - Operation selection: Deceleration to stop, Coast to stop, Emergency stop, or Continue operation

Table 7.6 External Fault Settings

Setting	Input level		Detection method		Operation selection			
	NO contact	NC contact	Always	During operation	Deceleration to stop (Fault)	Coast to stop (Fault)	Emergency stop (Fault)	Continue operation (Alarm)
20								
21								
22								
23								
24								
25								
26								
27								
28								
29								
2A								
2B								
2C								
2D								
2E								
2F								

- For the input level, select whether you want a fault to be detected when the input signal is ON (normally open input) or OFF (normally closed input).
- For the detection method, select whether you want faults to be detected any time that the Inverter is ON or only during operation.

- For the operation selection, select the processing method that you want to be performed when a fault has been detected.
 - Deceleration to stop: A fault is output and the output stopped in the selected deceleration time.
 - Coast to stop: A fault is output and the Inverter output is cut off.
 - Emergency stop: A fault is output and the output stopped in the emergency stop time (C1-09).
 - Continue operation: An alarm is output and operation continues.
- When an alarm is going to be output externally, be sure to set one of the multi-function outputs (H2-01, 02, and 03) to alarm (setting 10).
- An external fault setting cannot be set in more than one multi-function input.
- Unlike other constant settings, the external fault settings have an input procedure, as shown in the following diagrams.

Setting Procedure

1. When setting an external fault function, press the Enter Key when "External Fault" is displayed to bring up the "Input Level" display.

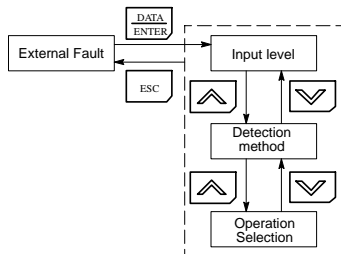

Fig 7.22 Setting Procedure for External Fault Function

2. Press the Increment Key to switch displays as follows:
"Detection Method" → "Operation Selection" → "Input Method"

7

上正科技有限公司

購買、維修 此手冊零組件

電話： 037-466333

Email: service@repairtw.com

Line id: @zzzz

www.repairtw.com

3. Press the Enter Key at the desired constant to select that constant.

At this point, the Increment and Decrement Keys can be pressed to scroll to the available settings for the selected constant. Press the Enter Key to select the displayed constant setting. (Press the Escape Key to cancel the operation without changing the constant setting.)

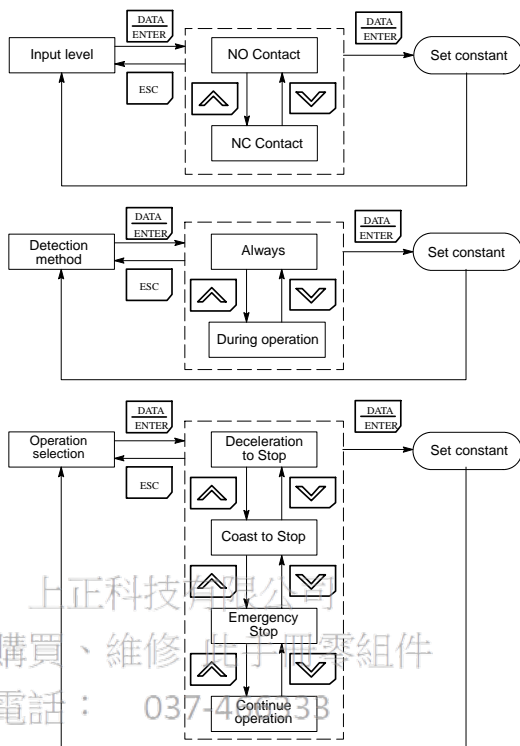

Fig 7.23 Procedure to Change Constant Settings

Line id: @zzzz

www.repairtw.com

DC Injection Braking Command (Setting: 60)

OFF	Normal operation
ON	Applies DC injection braking if the Inverter is stopped. (Applies initial excitation when flux vector control is being used.)

- DC injection braking is used to prevent the motor from rotating due to inertia or external forces when the Inverter is stopped.
- DC injection braking is performed if the DC injection braking input is ON while the Inverter is stopped.
- If a run command (jog, forward jog, or reverse jog) is input, the DC injection braking will be cleared and motor operation will be started.

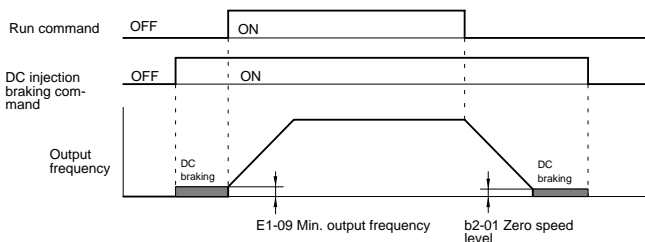

Fig 7.24 Timing Chart for DC Injection Braking Command

External Speed Search 1 (Settings: 61)

OFF	Normal operation
ON	Starts a speed search from the maximum output frequency.

External Speed Search 2 (Settings: 62)

OFF	Normal operation
ON	Starts a speed search from the set frequency (from the current reference frequency when the external search command turn ON).

- Either one of the external search functions can be set, but not both.
- The speed search function can be used to operate the motor without tripping when switching operation from a commercial power supply and the Inverter or starting a coasting motor.
- The speed search will begin after the minimum baseblock time (L2-03) has elapsed when the run command is input after the external search command has been turned ON.

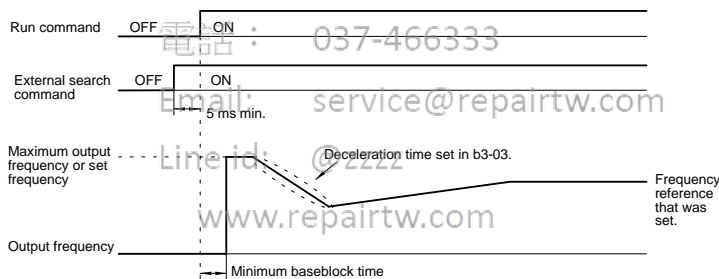

Fig 7.25 Timing Chart for the External Search Command

Speed Control (ASR) Proportional Gain Switch (Setting: 77)

OFF	The gain is set according to the values in C5-01, C5-03, and C5-07.
ON	The gain is set to the value in C5-03 (ASR proportional gain 2).

- With this setting, the multi-function input switches the proportional gain used in speed control (ASR). The integral time is not changed.
- Refer to 6.3.6 *Speed Control (ASR) Structure* for more details on constants C5-01, C5-03, and C5-07.

Multi-function Output Settings: H2

The settings and functions for the multi-function outputs are listed in *Table 7.7*.

Table 7.7 Multi-function Output Functions

Setting value	Function	Control Methods	
		Open Loop Vector	Flux vector
0	During run ON: run command is ON or voltage is being output)		
1	Zero-speed		
2	Frequency agree 1: (Detection width L4-02)		
3	Desired frequency agree 1 (ON: Output frequency = \pm L4-01, detection width in L4-02)		
4	Frequency (Four) detection 1 (ON: $+L4-01 \geq$ output frequency $\geq -L4-01$, detection width in L4-02)		
5	Frequency (Four) detection 2 (ON: Output frequency $\geq +L4-01$ or output frequency $\leq -L4-01$, detection width in L4-02)		
6	Inverter operation ready READY: After initialization, no faults		
7	During DC bus undervoltage (UV) detection		
8	During baseblock (ON: during baseblock)		
9	Frequency reference selection (ON: Frequency reference from Operator)		
A	Run command selection (ON: Run command from Operator)		
B	Overtorque detection 1 NO (NO contact: Overtorque detection at ON)		
C	Loss of frequency reference (Effective when operation selection is "1" for L4-05 frequency reference missing)		
D	Braking resistor fault (ON: Resistor overheat or braking transistor fault)		
E	Fault (ON: Faults other than CPF00, CPF01 have occurred.)		
F	Not used. (Do not set.)		
10	Minor fault (ON: Alarm displayed)		
11	Fault reset command active		
13	Frequency agree 2 (Detection width: L4-04)		
14	Desired frequency agree 2 (ON: Output frequency = L4-03, detection width in L4-04)		
15	Frequency detection 3 (ON: Output frequency $\leq -L4-03$, detection width in L4-04)		
16	Frequency detection 4 (ON: Output frequency $\geq -L4-03$, detection width in L4-04)		
17	Overtorque detection 1 NC (NC Contact: Torque detection at OFF)		
18	Overtorque detection 2 NO (NO Contact: Torque detection at ON)		
19	Overtorque detection 2 NC (NC Contact: Torque detection at OFF)		
1A	During reverse run (ON: During reverse run)		
1B	During baseblock 2 (OFF: During baseblock)		
1C	Motor selection (ON: During motor 1 selection)		
1D	Regenerating (ON: Regenerating)		
1E	Restart enabled (ON: Restart enabled)		
1F	Motor overload (OL1) pre-alarm (ON: 90% or more of the detection level)		
20	Inverter overheat (OH) pre-alarm (ON: Temperature exceeds L8-02 setting)		
30	During torque limit (current limit) (ON: During torque limit)		
31	During speed limit. (ON: During speed limit)		
37	During run 2 (ON: Frequency output, OFF: Base block, DC injection braking, initial excitation, operation stop.		
40	Zero-speed 2 (ON: Zero-speed, not included during Y/ winding change)		
41	Motor selection (ON: During motor 2 selection)		

Constant Settings

User Constant Number	Name	Change during Operation	Setting Range	Unit	Factory Setting	Valid Access Levels	
						Open Loop Vector	Flux Vector
H2-01	Multi-function input (terminal 9-10)		0 to 41	-	0	B	B
H2-02	Multi-function input (terminal 25)		0 to 41	-	1	B	B
H2-03	Multi-function input (terminal 26)		0 to 41	-	2	B	B

- The following table shows the settings and section references for functions that are described in more detail in this chapter.

Function	Setting	Section
Frequency Agree 1	2	<i>Frequency Detection Settings: L4-01 to L4-05 in 7.3.6</i>
Desired Frequency Agree 1	3	
Frequency Detection 1	4	
Frequency Detection 2	5	
Overtorque Detection 1 (NO)	B	<i>Overtorque Detection Settings: L6-01 to L6-06 in 7.3.6</i>
Loss of Frequency Reference	C	<i>Timer Functions: b4-01, b4-02 in 7.3.1</i>
Timer Function Output	12	
Frequency Agree 2	13	<i>Frequency Detection Settings: L4-01 to L4-05 in 7.3.6</i>
Desired Frequency Agree 2	14	
Frequency Detection 3	15	
Frequency Detection 4	16	
Overtorque Detection 1 (NC)	17	<i>Overtorque Detection Settings: L6-01 to L6-06 in 7.3.6</i>
Overtorque Detection 2 (NO)	18	
Overtorque Detection 2 (NC)	19	

- Refer to *Table 7.7 Multi-function Output Functions* for information on the following functions.

Function	Setting
Inverter Operation Ready	6
DC Bus Undervoltage	7
During Baseblock	8
Frequency Reference Selection	9
Run Command Selection	A
Braking Resistor Fault	D
Fault	E
Minor Fault	10
Fault Reset Command Active	H
During Reverse Run	1A
During Baseblock 2	1B
Regenerating	1D
Restart Enabled	1E
During Torque Limit (Current Limit)	30
During Speed Limit	31

During Run (Setting: 0)

OFF	The run command is OFF and there is not output voltage.
ON	The run command is ON or a voltage is being output.

During Run 2 (Setting: 37)

OFF	The Inverter is not outputting a frequency. (Baseblock, DC injection braking, initial excitation, or stopped)
ON	The Inverter is outputting a frequency.

- These outputs can be used to indicate the Inverter's operating status.

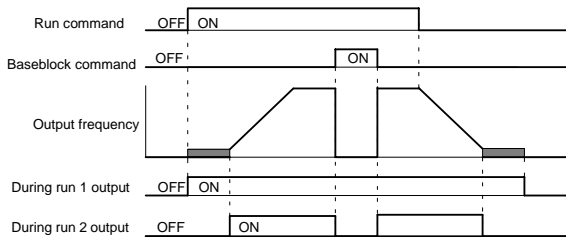

Fig 7.26 Timing Chart for "During RUN" Output

Zero-speed (Setting: 1)

OFF	The output frequency is greater than the minimum output frequency (E1-09). (With flux vector control, motor speed is greater than the zero speed level (b2-01).)
ON	The output frequency is less than the minimum output frequency (E1-09). (With flux vector control, motor speed is less than the zero speed level (b2-01).)

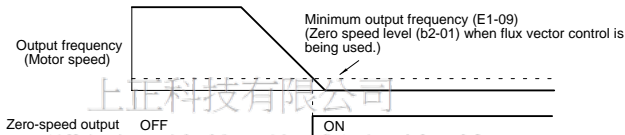

Fig 7.27 Timing Chart for Zero-speed

Motor Overload (OL1) Pre-alarm (Setting: 1F)

OFF	The motor protection function's electronic thermal value is less than 90% of the detection level.
ON	The motor protection function's electronic thermal value is greater than 90% of the detection level.

- This output function is valid when the motor overload protection function is enabled (L1-01 = 1).
- This output can be used to warn of overheating before the protection function itself operates.

Inverter Overheat (OH) Pre-alarm (Setting: 20)

OFF	The cooling fin temperature is less than the "OH Pre-Alarm Level" set in L8-02.
ON	The cooling fin temperature exceeds the "OH Pre-Alarm Level" set in L8-02.

- This output function indicates that the temperature of the cooling fins reaches the temperature set in L8-02 (the Inverter overheating alarm detection level).

Speed reference limit (Setting: 31)

OFF	Other than ON condition
ON	Enables the speed reference limit in the following conditions (During flux vector control mode): 1. Frequency reference Frequency reference upper limit (d2-01) Frequency reference Frequency reference lower limit (d2-02) Frequency reference Output frequency lower limit of the multi-function analog input (Setting: 9) 2. The frequency reference is less than the Min. output frequency (E1-09), and b1-05 is set to 1, 2, or 5.

■ Multi-function Analog Input/Frequency Reference (Current): H3-05, H3-09

Constant Settings

User Constant Number	Name	Change during Operation	Setting Range	Unit	Factory Setting	Valid Access Levels	
						Open Loop Vector	Flux Vector
H3-05	Multi-function analog input (terminal 16)		0 to 1F	-	0	B	B
H3-09	Multi-function analog input (terminal 14)		0 to 1F	-	1F	A	A

Table 7.8 Multi-function Input/Frequency Reference (Voltage) Function

Setting	Function	Equivalent of 100% Input (10 V or 20 mA)	Control Method	
			Open-loop Vector	Flux Vector
0	Auxiliary frequency reference (H3-05)	Maximum output frequency		
1	Frequency gain	Frequency reference (voltage) command value		
2	Frequency bias	Maximum output frequency (added to H3-03)		
5	Accel/Decel change (reduction coefficient)	Accel/Decel times (C1-01 to C1-08)		
6	DC injection braking current	Inverter rated output current		
7	Overtorque detection level	Motor rated torque		
9	Frequency reference lower limit level	Maximum output frequency		
A	Jump frequency	Maximum output frequency		
10	Forward side torque limit	Motor rated torque		
11	Reverse side torque limit	Motor rated torque		
12	Regeneration for torque limit	Motor rated torque		
13	Torque reference/torque limit for speed control	Motor rated torque		
14	Torque compensation bias	Motor rated torque		
15	Forward/reverse torque limit	Motor rated torque		
1F	Disable analog input (H3-05)	--		
	Frequency Reference (H3-09)	Maximum output frequency		

- The analog input signal level, gain, and bias are set with the following constants.

Terminal 16 signal level selector	H3-04 (0 to +10 V or 0 to ± 10 V)
Terminal 16 input gain	H3-06
Terminal 16 input bias	H3-07
Terminal 14 signal level selector	H3-08 (0 to ± 10 V, 0 to ± 10 V, or 4 to 20 mA)
Terminal 14 input gain	H3-10
Terminal 14 input bias	H3-11

- When a voltage input is being input to terminal 14, be sure to disconnect jumper wire J1 on the control PC board.
- The input resistance will be destroyed if a voltage input is used without disconnecting the jumper wire.
- Set the time constant in constant H3-12 when adding a primary delay filter to an analog input. This filter time constant applies to all three of the analog inputs.
- Settings 2 and D cannot be set at the same time. OPE07 will be detected.

Analog Input Characteristics

- Analog input characteristics for a gain of 100.0% and a bias of 0.0% are shown for setting examples in *Table 7.9*.
- To set over 100% for a 10 V input (e.g., 300%/10 V), set the gain to 300% in H3-06 for terminal 16 and H3-10 for terminal 14.

Table 7.9 Analog Input Characteristics

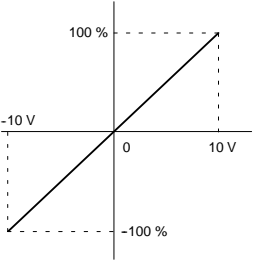
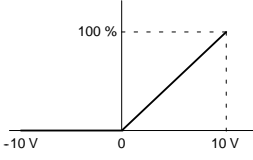
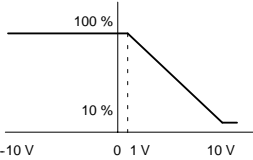
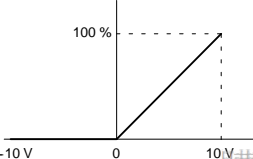
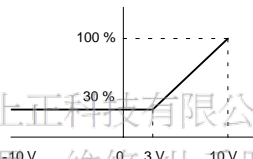
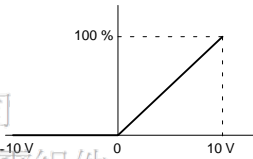
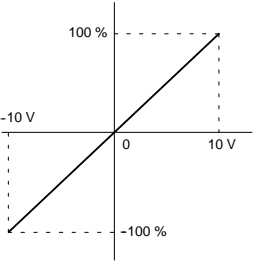
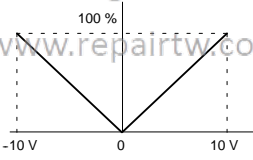
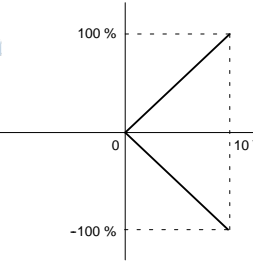
<ul style="list-style-type: none"> • Auxiliary Frequency Reference (Setting: 0) • Frequency Bias (Setting: 2) • PID Feedback (Setting: B) • Frequency reference (H3-09 setting: 1F) 	<ul style="list-style-type: none"> • Frequency Gain (Setting: 1) • Output Voltage Bias (Setting: 4) • DC Injection Braking Current (Setting: 6) 	<ul style="list-style-type: none"> • Acceleration/Deceleration Time Gain (Setting: 5)
	 <p>When set to 1, the setting of H3-02 will be added to achieve the final gain.</p>	
<ul style="list-style-type: none"> • DC Injection Braking Current (Setting: 6) • Overtorque Detection Level (Setting: 7) 	<ul style="list-style-type: none"> • Stall Prevention Level (Setting: 8) 	<ul style="list-style-type: none"> • Output Frequency Lower Limit (Setting: 9) • Jump Frequency (Setting: A)
 <p>Only the overtorque detection 1 output can be used when "7" is set to use overtorque detection for a multi-function output.</p>		
<ul style="list-style-type: none"> • Torque Reference (Setting: 13) • Torque Compensation Bias (Setting: 14) 	<ul style="list-style-type: none"> • Forward Torque Limit (Setting: 10) • Reverse Torque Limit (Setting: 11) • Regenerative Torque Limit (Setting: 12) 	<ul style="list-style-type: none"> • Forward/Reverse Torque (Speed) Limit (Setting: 15)
		

Multi-function Analog Output Settings: H4-01 to H4-07

Function Selection Constants: H4-01, H4-04

User Constant Number	Name	Change during Operation	Setting Range	Unit	Factory Setting	Valid Access Levels	
						Open Loop Vector	Flux Vector
H4-01	Monitor selection (terminal 21)		1 to 35	-	2	B	B
H4-04	Monitor selection (terminal 23)		1 to 35	-	3	B	B

- The multi-function outputs can be set to monitor any of the U1 Inverter status items by setting the last two digits of the constant number (U1-□□). Refer to page - 12 for a table listing all of these U1 settings.
- Settings 4, 10, 11, 12, 13, 14, 25, 28 and 34 can't be set and settings 29, 30, and 31 aren't used.

Adjusting the Monitor Output: H4-02, -03, -05, -06

User Constant Number	Name	Change during Operation	Setting Range	Unit	Factory Setting	Valid Access Levels	
						Open Loop Vector	Flux Vector
H4-02	Gain (terminal 21)		0.00 to 2.50	Multiple	1.00	B	B
H4-03	Bias (terminal 21)		-10.0 to +10.0	%	0.0	B	B
H4-05	Gain (terminal 23)		0.00 to 2.50	Multiple	0.50	B	B
H4-06	Bias (terminal 23)		-10.0 to +10.0	%	0.0	B	B

- For the output gain, set what multiple of 10 V will correspond to a 100% output of the monitored item.
- For the output bias, set the amount that the output characteristic will be shifted vertically. Set this amount as a percentage, with 10 V corresponding to 100%.

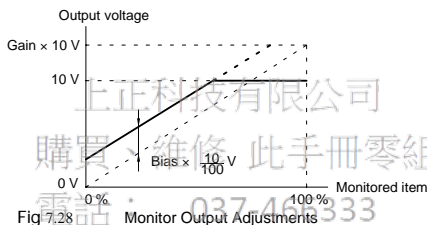

Fig 7.28 Monitor Output Adjustments

Multi-function Analog Output Signal Level: H4-07

User Constant Number	Name	Change during Operation	Setting Range	Unit	Factory Setting	Valid Access Levels	
						Open Loop Vector	Flux Vector
H4-07	Analog output-signal level selection		0 1	-	0	B	B

- Settings

Setting	Function
0	0 to +10 V (Absolute value output)
1	0 to 10 V

- This signal level setting applies to analog outputs 1 and 2 (terminals 21 and 23).
- When the 0 to ±10 V signal level is used to output speed values (frequency reference, output frequency, or motor speed), positive voltage indicates Inverter output in the forward direction and negative voltage indicates Inverter output in the reverse direction. (Assuming a bias setting of 0.0.)
- There are some monitor items that are limited to the 0 to +10 V signal range even when the 0 to ±10 V signal level has been selected. Refer to Table 4.3 Status Monitor Items for details.

MEMOBUS Communications Settings: H5-01 to H5-05

Station Node Address: H5-01

- Set the Inverter node address.

User Constant Number	Name	Change during Operation	Setting Range	Unit	Factory Setting	Valid Access Levels	
						Open Loop Vector	Flux Vector
H5-01	Station address		0 to 20	-	1F	A	A

Baud Rate: H5-02

- Set the baud rate for MEMOBUS communications.

User Constant Number	Name	Change during Operation	Setting Range	Unit	Factory Setting	Valid Access Levels	
						Open Loop Vector	Flux Vector
H5-02	Communication speed selection		0 to 3	-	3	A	A

- Settings

Setting	Function
0	1200 bps
1	2400 bps;
2	4800 bps
3	9600 bps

Communication Parity: H5-03

- Set the parity for MEMOBUS communications.

User Constant Number	Name	Change during Operation	Setting Range	Unit	Factory Setting	Valid Access Levels	
						Open Loop Vector	Flux Vector
H5-03	Communication parity selection		0 to 2	-	0	A	A

- Settings

Setting	Function
0	No parity
1	Even parity
2	Odd parity

Stopping Method after Communications Error: H5-04

- Set the stopping method to used after a communications error is detected.

User Constant Number	Name	Change during Operation	Setting Range	Unit	Factory Setting	Valid Access Levels	
						Open Loop Vector	Flux Vector
H5-04	Stopping method after communication error		0 to 3	-	3	A	A

- Settings

Setting	Function
0	Deceleration to stop (deceleration time:C1-02)
1	Coast to stop
2	Emergency stop (deceleration time:C1-09)
3	Continue operation (display only)

Communications Error Detection: H5-05

- Set whether or not to detect a communications timeout as a communications error.

User Constant Number	Name	Change during Operation	Setting Range	Unit	Factory Setting	Valid Access Levels	
						Open Loop Vector	Flux Vector
H5-05	Communication error detection selection		0 1	-	1	A	A

- Settings

Setting	Function
0	Do not detect as communications error.
1	Detect as communications error.

7.3.6 Protective Functions: L

■ Motor Protection Settings: L1-01, L1-02

Motor Protection Selection: L1-01

User Constant Number	Name	Change during Operation	Setting Range	Unit	Factory Setting	Valid Access Levels	
						Open Loop Vector	Flux Vector
L1-01	Motor protection selection		0 1	-	1	B	B

• Settings

Setting	Function
0	Disabled.
1	Enabled.

- This setting enables or disables the motor overload protection function.
- The rated current setting (E2-01) is used as a basis for overload detection.
- Disable the motor protection function (setting 0) when two or more motors are connected to a single Inverter. Use another method to provide overload protection separately to each motor, such as connecting a thermal overload relay to the power line of each motor.
- The motor protection function may not protect a motor when the power supply is turned ON and OFF frequently, because the thermal value is reset each time that the power is turned OFF.
- If the Overload OL1 alarm (1F) is set in one of the multi-function outputs (H2-01 to H2-03), the output will be turned ON when the electronic thermal value reaches 90% of the overload detection level.

Motor Protection Time Constant: L1-02

User Constant Number	Name	Change during Operation	Setting Range	Unit	Factory Setting	Valid Access Levels	
						Open Loop Vector	Flux Vector
L1-02	Motor protection time constant		0.1 to 5.0	Minutes	1.0	B	B

- Normally it isn't necessary to change this setting. (The factory setting is a 150%, 1 minute capacity.)
- Set the electronic thermal protection operation time if a 150% overload is applied after operating continuously at the motor's rated current (hot start).
- When the motor's overload capacity level is known, set the hot-start overload resistance level for the motor, but be sure to allow some margin for safety.
- Decrease this setting when you want to detect an overload more quickly.

Electronic Thermal Time Characteristics
In this example, L1-02 is set to 1 minute, the motor is operating at 60 Hz, and general-purpose motor characteristics are used.

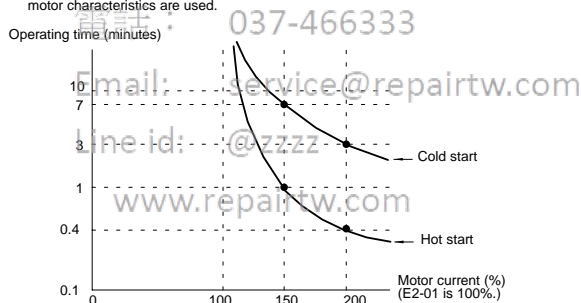

Fig 7.29 Motor Protection Operating Time

■ Momentary Power Loss Settings: L2-01 to L2-05

Momentary Power Loss Detection: L2-01

User Constant Number	Name	Change during Operation	Setting Range	Unit	Factory Setting	Valid Access Levels	
						Open Loop Vector	Flux Vector
L2-01	Momentary power loss detection		0 to 2	-	0	B	B

- Settings

Setting	Function
0	Disabled. (An undervoltage fault is detected when there is a momentary power loss.)
1	Enabled. (Restarts if power is restored within the L2-02 time. An under-voltage fault is detected for a longer power loss.)
2	Enabled during CPU operation. (Restarts if power is restored while the CPU is operating. An undervoltage fault is not detected.)

- This constant specifies the processing that is performed when a momentary power loss occurs.
- When power loss ridethru is enabled (setting 1 or 2), operation will be restarted after a speed search if the power is restored within the allowed time interval.
- When power loss ridethru is disabled (setting 0), an undervoltage fault will be detected if power is interrupted for more than 15 ms.

Momentary Power Loss Ridethru Time: L2-02

User Constant Number	Name	Change during Operation	Setting Range	Unit	Factory Setting	Valid Access Levels	
						Open Loop Vector	Flux Vector
L2-02	Momentary power loss ridethru time		0.0 to 2.0	s	0.7	B	B

- The factory setting depends on the Inverter capacity. The factory setting shown in the table is for a 200 V class, 0.4 kW Inverter. (See page NO TAG.)
- This setting is valid only when constant L2-01 is set to 1. Set the power loss ridethru time in seconds.

上正科技有限公司

購買、維修 此手冊零組件

電話： 037-466333

Email: service@repairtw.com

Line id: @zzzz

www.repairtw.com

Minimum Baseblock Time: L2-03

User Constant Number	Name	Change during Operation	Setting Range	Unit	Factory Setting	Valid Access Levels	
						Open Loop Vector	Flux Vector
L2-03	Min. baseblock time		0.0 to 5.0	s	0.5	B	B

- The factory setting depends on the Inverter capacity. The factory setting shown in the table is for a 200 V class, 0.4 kW Inverter. (See page NO TAG.)
- This setting is used with the speed search and DC injection braking functions.
- Set the time required for the leakage voltage to dissipate. Increase the setting if an overcurrent (OC) occurs when the speed search or DC injection braking function starts.
- Set the baseblock time during winding change. Time for winding change varies according to the setting. (For example, lower the setting, and time for winding change is also reduced.) Overcurrent (OC) might occur if setting is too low.
- This setting is valid for speed searches performed after a momentary power loss and regular speed searches.

Voltage Recovery Time: L2-04

User Constant Number	Name	Change during Operation	Setting Range	Unit	Factory Setting	Valid Access Levels	
						Open Loop Vector	Flux Vector
L2-04	Voltage recovery time		0.0 to 5.0	s	0.3	A	A

- Set the time allowed for the normal voltage to be restored after completion of the speed search. For a 200 V class Inverter, this is the time in seconds for voltage to be restored from 0 VAC to 200 VAC. For a 400 V class Inverter, this is the time in seconds for voltage to be restored from 0 VAC to 400 VAC.
- This setting is valid for speed searches after a momentary power loss, regular speed searches, the voltage changes with energy-saving control, and the voltage changes with baseblock clearing.
- Set the voltage recovery time after baseblock during winding change. Overvoltage (OV) might occur if setting is too low.

Undervoltage Detection Level: L2-05

User Constant Number	Name	Change during Operation	Setting Range	Unit	Factory Setting	Valid Access Levels	
						Open Loop Vector	Flux Vector
L2-05	Undervoltage detection level		150 to 210 (300 to 420)	VDC	190 (380)	A	A

- The values in parentheses are for 400 V class Inverters. (See page NO TAG.)
- Normally it isn't necessary to change this setting.
- Use this constant when you want to add an AC reactor and lower the main circuit undervoltage detection level. Be sure to set a main circuit DC voltage value (V) that will detect a main circuit undervoltage.

KEB Deceleration Rate L2-06

User Constant Number	Name	Change during Operation	Setting Range	Unit	Factory Setting	Valid Access Levels	
						Open Loop Vector	Flux Vector
L2-06	KEB deceleration rate		0.0 to 100.0	0.1	0.0	A	A

- The KEB function restores the operating conditions for momentary power loss by applying a frequency deceleration to create inertia energy when a power loss occurs, and thus avoid the power loss.
- This function is normally used with film lines and other applications where multiple Inverters are connected to the main DC line. Synchronous deceleration for power loss prevents the line from stopping as the result of speed fluctuations.
- The KEB operation is performed using a KEB command (setting of 65 or 66) for a multi-function input.
- Applicable Capacities
200 V class Inverters: 0.4 to 15 kW
400 V class Inverters: 0.4 to 18.5 kW

Operation

- L2-06 = 0

The motor is automatically accelerated based on the emergency stop time (C1-09) so that the DC main-line voltage does not go below the UV level. The momentary power loss ride-thru time (L2-02) is not used.

- L2-06 = 0

The motor is decelerated to the KEB frequency level using the momentary power loss ride-thru time (L2-02) and then is accelerated to the original frequency reference using acceleration time 1 (C1-01). The KEB frequency level is calculated from the KEB frequency rate using the following equation.

KEB frequency level = Output frequency before power loss $[1 - (\text{setting of L2-06}/100)]\%$

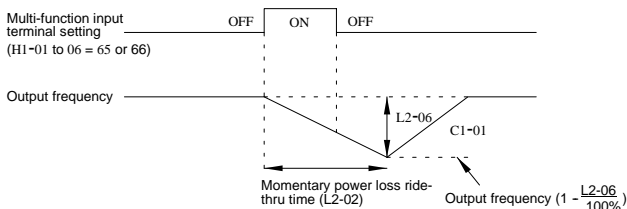

■ Stall Prevention Function Settings: L3-01 to L3-06

- A stall occurs if the rotor cannot keep up with the rotating magnetic field on the motor stator side when a large load is applied to the motor or a sudden acceleration/deceleration is performed.
- In the Inverter, stall prevention functions can be set independently for accelerating, running, and decelerating. (Some functions are restricted depending on the control method.)

Stall Prevention Selection During Acceleration: L3-01

User Constant Number	Name	Change during Operation	Setting Range	Unit	Factory Setting	Valid Access Levels	
						Open Loop Vector	Flux Vector
L3-01	Stall prevention selection during accel		0 to 2	-	1	B	

- Settings

Setting	Function
0	Disabled. (Accelerate according to the settings. Stalls may occur with large loads.)
1	Enabled. (Stop acceleration if L3-02 setting is exceeded. Accelerate again when current recovers.)
2	Optimum acceleration (Adjust acceleration so that the L3-02 isn't exceeded by much. Disregard the acceleration time setting.)

- When setting 1 (enabled) is selected, acceleration is stopped if the motor current exceeds the acceleration stall prevention level. Acceleration is started again when the current falls below this level. The acceleration time can be longer than the setting depending on the load.
- When setting 2 (optimum acceleration) is selected, acceleration is performed using the acceleration stall prevention level as a basis. In this case, the acceleration time is disregarded.

Stall Prevention Level During Acceleration: L3-02

User Constant Number	Name	Change during Operation	Setting Range	Unit	Factory Setting	Valid Access Levels	
						Open Loop Vector	Flux Vector
L3-02	Stall prevention level during accel		0 to 200	%	150	B	

- This setting is valid when L3-01 is set to 1 or 2.
- Normally it isn't necessary to change this setting.
- Decrease this setting when the motor capacity is small compared to the Inverter capacity or stalling occurs when the motor is operated with the factory setting. The standard target setting is 2 to 3 times the motor's rated current. (Set this current value as a percentage of the Inverter's rated current, i.e., 100% corresponds to the Inverter's rated current.)

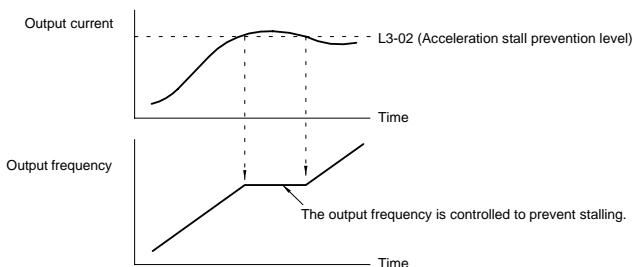
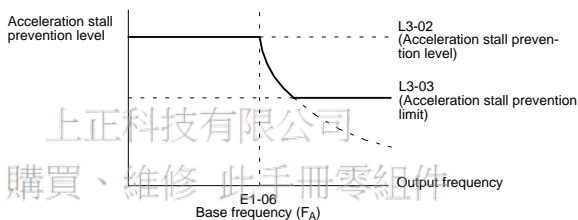

Fig 7.30 Acceleration Stall Prevention Function: L3-01 = 1

Stall Prevention Limit During Acceleration: L3-03

User Constant Number	Name	Change during Operation	Setting Range	Unit	Factory Setting	Valid Access Levels	
						Open Loop Vector	Flux Vector
L3-03	Stall prevention limit during accel		0 to 100	%	50	A	

- Normally it isn't necessary to change this setting.
- Set this constant when a high-speed motor is being used in the high-speed range (the high frequency range above the base frequency).
- The standard target setting is the motor's rated current. Set this current value as a percentage of the Inverter's rated current, i.e., 100% corresponds to the Inverter's rated current.



Note When the motor is used in the high-speed range, the acceleration stall prevention level is automatically lowered to provide smoother acceleration.
The acceleration stall prevention limit (L3-03) limits how much the acceleration stall prevention level is lowered so that it isn't lowered any more than necessary.

Fig 7.31 Stall Prevention Limit During Acceleration

Line id: @zzzz

www.repairtw.com

Stall Prevention Selection During Decel: L3-04

User Constant Number	Name	Change during Operation	Setting Range	Unit	Factory Setting	Valid Access Levels	
						Open Loop Vector	Flux Vector
L3-04	Stall prevention selection during decel		0 to 3	-	1	B	B

- Settings

Setting	Function
0	Disabled. (Decelerate according to the settings. Main circuit overvoltage may occur if the deceleration time is too short.)
1	Enabled. (Stops deceleration if the main circuit voltage exceeds the overvoltage level. Decelerate again when voltage recovers.)
2	Optimum deceleration. (Decelerate as fast as possible judging from the main circuit voltage. Disregard the deceleration time setting.)
3	Enabled (with braking resistor)

- When setting 1 (enabled) is selected, the deceleration time is extended automatically so that a main circuit overvoltage doesn't occur.
- Always select setting 0 or 3 when a braking option (Braking Resistor, Braking Resistor Unit, or Braking Unit) is being used. If setting 1 or 2 is selected, the braking option won't be used and the deceleration time can't be shortened.
- L3-04 cannot be set to 2 for open-loop vector control mode. (Settings can be made for SPEC: F and later)
- L3-04 = 3 cannot be set to 2 for vector control modes.

Settings: Differences Between 0 and 3

- When set to 0, the stall prevention cannot be used when decelerating.
- When set to 3, disabled if over voltage (OV) occurs often in the main circuit, the deceleration time is automatically extended slightly. In other cases, deceleration occurs within the specified deceleration time. The actual deceleration time may be longer than the specified deceleration time, but a deceleration time that is lower than that when set to 0 is also possible. When the setting for stall prevention during deceleration is set to 3, be sure to make adjustments according to the following procedure:

Adjusting the Settings

- Set the deceleration time according to the braking power and machine inertia.
- When the braking power or the machine inertia is unknown, set L3-04 to 0 and do a trial run to determine the minimum deceleration time. Then set L3-04 to 3.
- Lower the (setting for the) deceleration time to a value in the range where main circuit overvoltages (OV) will not occur.

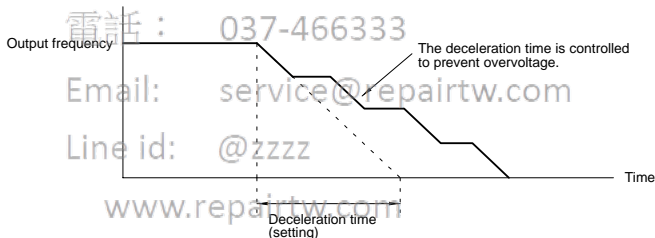

Fig 7.32 Deceleration Stall Prevention Function: L3-04 = 1

- Frequency Detection Settings: L4-01 to L4-05

User Constant Number	Name	Change during Operation	Setting Range	Unit	Factory Setting	Valid Access Levels	
						Open Loop Vector	Flux Vector
L4-01	Speed agree detection level		0.0 to 400.0	Hz	0.0	B	B
L4-02	Speed agree detection width		0.0 to 20.0	Hz	2.0	B	B

User Constant Number	Name	Change during Operation	Setting Range	Unit	Factory Setting	Valid Access Levels	
						Open Loop Vector	Flux Vector
L4-03	Speed agree detection level (+/-)		-400.0 to +400.0	Hz	0.0	A	A
L4-04	Speed agree detection width (+/-)		0.0 to 20.0	Hz	2.0	A	A

- Set these constants when outputting one of the frequency agree or frequency detection signals from a multi-function output. *Table 7.10* shows the relationship between these constants and the output signals.
- Motor speed is detected at Flux Vector Control.

Table 7.10 Constants and Output Signals

Constant	Related output settings	Constant function
Speed Agree Level (Absolute value)	Fref/Set Agree 1 Frequency Detection 1 > Frequency Detection 2 <	Set the frequency (or motor speed) that you want to detect in Hz. The set speed is an absolute value, so the speed is detected in forward or reverse.
Speed Agree Width (Absolute value)	Fref/Fout Agree 1 Fref/Set Agree 1 Frequency Detection 1 > Frequency Detection 2 <	Set the frequency (or motor speed) detection range in Hz.
Speed Agree Level +/- (Signed value)	Fref/Set Agree 2 Frequency Detection 3 > Frequency Detection 4 <	Set the frequency (or motor speed) that you want to detect in Hz. Set positive values for forward, negative values for reverse.
Speed Agree Width +/- (Signed value)	Fref/Fout Agree 2 Fref/Set Agree 2 Frequency Detection 3 > Frequency Detection 4 <	Set the frequency (or motor speed) detection range in Hz.

- Set the corresponding setting in the multi-function output (H2-01, H2-02, or H2-03) to output the desired Fref/Fout Agree signal, Fref/Set Agree signal, or Frequency Detection signal.

Function	Setting
Fref/Fout Agree 1	2
Fref/Set Agree 1	3
Frequency Detection 1	4
Frequency Detection 2	5
Fref/Fout Agree 2	13
Fref/Set Agree 2	14
Frequency Detection 3	15
Frequency Detection 4	16

Frequency Detection Operation: L4-05

User Constant Number	Name	Change during Operation	Setting Range	Unit	Factory Setting	Valid Access Levels	
						Open Loop Vector	Flux Vector
L4-05	Operation when frequency reference is missing		0 1	-	0	A	A

- The frequency reference is considered lost when the frequency reference voltage drops by 90% for more than 400 ms.

- Settings

Setting	Function
0	Stop. (Operate according to the frequency reference value.)
1	Continue operation at 80% speed. (Continue operation with a speed that is 80% of the value when the frequency reference was lost.)

- Timing Chart for Frequency Detection Operation

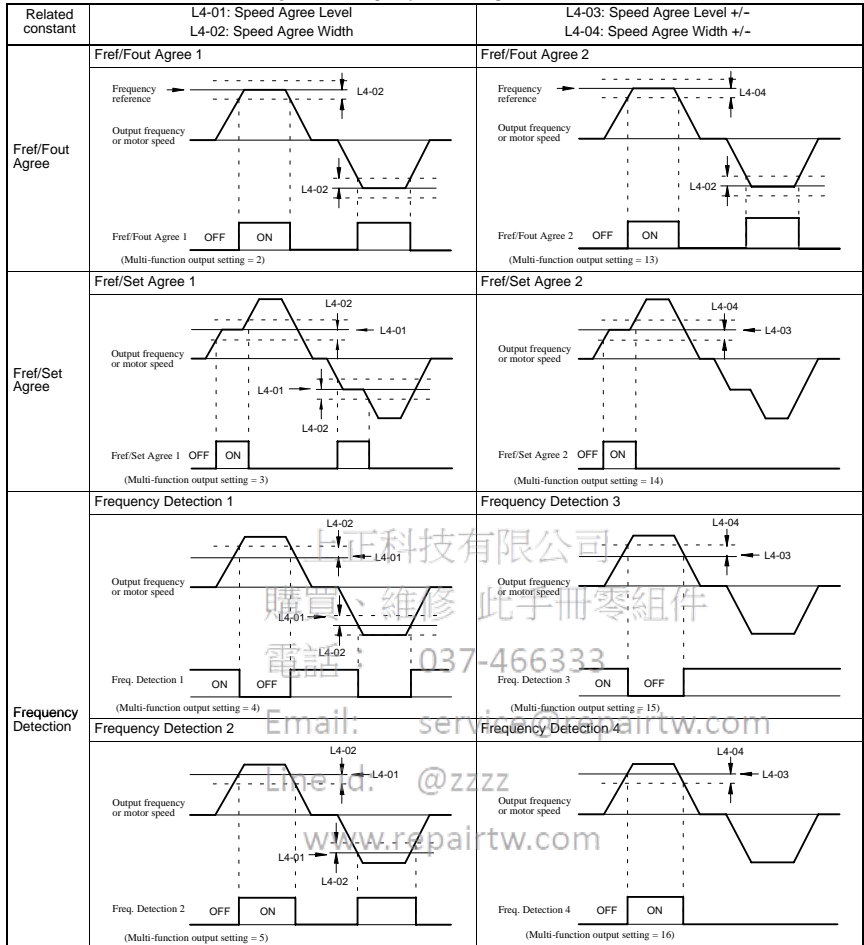

■ Fault Restart Settings: L5-01, L5-02

Number of Auto Restart Attempts: L5-01

User Constant Number	Name	Change during Operation	Setting Range	Unit	Factory Setting	Valid Access Levels	
						Open Loop Vector	Flux Vector
L5-01	Number of auto restart attempts		0 to 10	---	0	B	B

IMPORTANT

- The Inverter might be damaged when using the fault restart function too frequently.
- Understanding that the Inverter might be damaged, be sure to take the following precautions:
Always set up a molded-case circuit breaker (MCCB).
Set up a sequence that will stop peripheral equipment when an Inverter fault occurs.

- The fault restart function automatically restarts the Inverter even when an internal fault occurs during Inverter operation. Use this function only when continuing operation is more important than possibly damaging the Inverter.
- The fault restart function is effective with the following faults. With other faults, the protective operations will engage immediately without attempting to restart operation.
 - OC (Overcurrent)
 - GF (Ground fault)
 - PUF (Fuse blown)
 - OV (Main circuit overvoltage)
 - UV1 (Main circuit undervoltage)
 - PF (Main circuit voltage fault)
 - LF (Output open-phase)
 - RF (Braking resistor overheated)
 - RR (Braking transistor fault)
 - OL1 (Motor overload)
 - OL2 (Inverter overload)
 - OL3 (Overtorque)
 - OL4 (Overtorque)
- The fault restart count is cleared in the following cases:
 - When operation is normal for 10 minutes after a fault restart is performed.
 - When the fault reset input is received after the protection operation has been activated and the fault confirmed.
 - When the power is turned OFF and then ON again.
- When one of the multi-function outputs (H2-01, H2-02, or H2-03) is set to 1E (Restart Enabled), the output will be ON while the fault restart function is in progress.

Auto Restart Operation Selection: L5-02

User Constant Number	Name	Change during Operation	Setting Range	Unit	Factory Setting	Valid Access Levels	
						Open Loop Vector	Flux Vector
L5-02	Auto restart operation selection		0-1		0	B	B

- Settings

Setting	Function
0	Do not output fault restart. (The fault contact does not operate.)
1	Output fault restart. (The fault contact operates.)

■ Overtorque Detection Settings: L6-01 to L6-06

User Constant Number	Name	Change during Operation	Setting Range	Unit	Factory Setting	Valid Access Levels	
						Open Loop Vector	Flux Vector
L6-01	Torque detection selection 1		0 to 4	-	0	B	B
L6-02	Torque detection level 1		0 to 300	%	150	B	B
L6-03	Torque detection time 1		0.0 to 10.0	s	0.1	B	B
L6-04	Torque detection selection 2		0 to 4	-	0	A	A
L6-05	Torque detection level 2		0 to 300	%	150	A	A
L6-06	Torque detection time 2		0.0 to 10.0	s	0.1	A	A

- The overtorque detection function detects an excessive mechanical load from an increase in the output current (or output torque).

- The settings in the torque detection selection constants (L6-01 and L6-04) determine whether overtorque conditions will be detected and what kind of processing will be performed if a overtorque condition is detected.
- L6-01/L6-04 Settings

Setting	Function	Display	
0	Overtorque detection disabled	Overtorque detection 1	Overtorque output 2
1	Detect only during speed agree. Continue operation even after detection. (Minor fault)	"OL3" blinks	"OL4" blinks
2	Detect overtorque at any time. Continue operation even after detection. (Minor fault)	"OL3" blinks	"OL4" blinks
3	Detect only during speed agree. Stop output after detection. (Fault)	"OL3" lights	"OL4" lights
4	Detect overtorque at any time. Stop output after detection. (Fault)	"OL3" lights	"OL4" lights

- When overtorque detection is enabled, be sure to set the overtorque detection level (L6-02 or L6-05) and the overtorque detection time (L6-02 or L6-05). An overtorque condition is detected when the current exceeds the overtorque detection level for longer than the overtorque detection time.
- The overtorque detection level is set as a percentage of the motor rated torque.
- Any of the following functions can be set in a multi-function output (H2-01, H2-02, or H2-03) to indicate fact that an overtorque condition has been detected.
 - Setting B: Overtorque detection 1 (NO)
 - Setting 18: Overtorque detection 2 (NO)
 - Setting 17: Overtorque detection 1 (NC)
 - Setting 19: Overtorque detection 2 (NC)

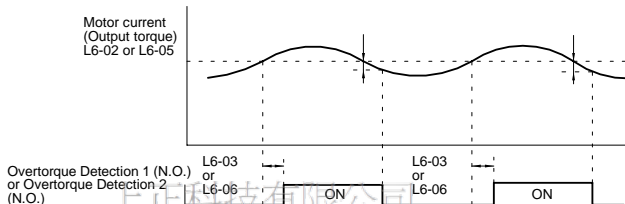

* The overtorque detection is cleared when the current drops about 5% of the Inverter's rated current (or the motor's rated torque).

Fig 7.33 Timing Chart for Overtorque Detection

Hardware Protection Settings: L8-01 to L8-03, L8-05, L8-07

Protection Selection for Internal DB Resistor: L8-01

User Constant Number	Name	Change during Operation	Setting Range	Unit	Factory Setting	Valid Access Levels	
						Open Loop Vector	Flux Vector
L8-01	Protect selection for internal DB resistor		0 to 3	-	0	B	B

Settings

Setting	Function
0	Disabled. (Select 0 when a braking resistor isn't being used or a Braking Resistor Unit is being used.)
1	Enabled. (Protects the braking resistor from overheating.)
2	3%ED
3	10%ED

Inverter Overheating (OH) Pre-alarm Settings: L8-02 L8-03

User Constant Number	Name	Change during Operation	Setting Range	Unit	Factory Setting	Valid Access Levels	
						Open Loop Vector	Flux Vector
L8-02	Overheat pre-alarm level		50 to 110		95	A	A
L8-03	Operation selection after overheat pre-alarm		0 to 3	-	3	A	A

- Constant L8-02 specifies the detection temperature in °C for the Inverter overheat (OH) pre-alarm function. An overheat pre-alarm occurs when the temperature of the cooling fins reaches this level.
- Constant L8-03 specifies the processing that will be performed when an overheat pre-alarm occurs. Apart from this setting, cooling fin overheating (OH1) is detected as a protection function at 105 °C.
- Settings

Setting	Function
0	Decelerates to a stop in the deceleration time set in C1-09. (Protection operation: Fault contacts operate)
1	Coast to stop. (Protection operation: Fault contacts operate)
2	Emergency stop in the emergency-stop time set in C1-09. (Protection operation: Fault contacts operate)
3	Continues operation. (Alarm: Monitor display only.)

Input Open-phase Protection Selection: L8-05

User Constant Number	Name	Change during Operation	Setting Range	Unit	Factory Setting	Valid Access Levels	
						Open Loop Vector	Flux Vector
L8-05	Input open-phase protection selection		0 1	-	0	A	A

- This function detects changes in the main circuit DC voltage which indicate a power supply open-phase, large imbalance in the power supply voltage, or deterioration of the main circuit capacitor.
- Settings

Setting	Function
0	Disabled.
1	Enabled. (Detects input power supply open-phase, 3-phase imbalance, or deterioration of the main circuit capacitor.)

Output Open-phase Protection Selection: L8-07

- This function detects an Inverter output open-phase.

User Constant Number	Name	Change during Operation	Setting Range	Unit	Factory Setting	Valid Access Levels	
						Open Loop Vector	Flux Vector
L8-07	Output open-phase protection selection		0 1	-	0	A	A

- Settings

Setting	Function
0	Disabled.
1	Enabled. (Detects an output open-phase at under 10% of the Inverter's rated output current.)

- False open-phase detections may occur when the motor capacity is small compared to the Inverter capacity. In this case, disable the detection function by setting L8-07 to 0.

Carrier Frequency Reduction Selection: L8-17 (for SPEC: F)

User Constant Number	Name	Change during Operation	Setting Range	Unit	Factory Setting	Valid Access Levels	
						Open Loop Vector	Flux Vector
L8-17	Carrier frequency reduction selection 2		0 to 3	-	1	A	

• Settings

Setting	Function
0	No carrier frequency reduction.
1	With carrier frequency reduction.
2	For factory adjustments.
3	For factory adjustments.

- If metallic noise (carrier noise) from the motor is a problem when carrier frequency is reduced (less than 6 Hz), set L8-17 to 0 (no carrier frequency reduction), and L8-19 (OL2 characteristics selection at low speeds) to 1 (enabled).
- Do not L8-17 and L8-19 to 0 at the same time when using V/f control open loop vector control.

OL2 characteristics Selection at Low Speeds: L8-19 (for SPEC: F)

User Constant Number	Name	Change during Operation	Setting Range	Unit	Factory Setting	Valid Access Levels	
						Open Loop Vector	Flux Vector
L8-19	OL2 characteristics selection at low speeds		0 1	-	0	A	A

• Settings

Setting	Function
0	OL2 characteristics at low speeds disabled.
1	OL2 characteristics at low speeds enabled.

- When using OL2 to trip at low speeds (less than 6 Hz) despite a light load, set L8-17 to 1 (with carrier frequency reduction) and L8-19 (OL2 characteristics selection at low speeds) to 0 (disabled). However, do not set L8-19 to 0 for 400 V class, 185 to 300 kW Inverters.
- Do not L8-17 and L8-19 to 0 at the same time when using V/f control open loop vector control.
- Reduce the carrier frequency (C6-01) to 2 kHz when continuously operating at low speeds with heavy loads when using flux vector control.

購買、維修 此手冊零組件

電話： 037-466333

Email: service@repairtw.com

Line id: @zzzz

www.repairtw.com

7.3.7 Operator Constants: o

■ Operator Display Selection: o1-01 to o1-05

Constant Number Display Selection: o1-01

User Constant Number	Name	Change during Operation	Setting Range	Unit	Factory Setting	Valid Access Levels	
						Open Loop Vector	Flux Vector
o1-01	Constant No. display selection		4 to 35	-	6	B	B

- In operation mode, the frequency reference, output frequency, output current, and output voltage can be monitored immediately if the factory settings are being used. One of these four values, the output voltage, can be changed to a different value.
- When you want to monitor a value other than the output voltage, set that number in constant o1-01.
- Use the last two digits from the "U1 Monitor" list (U1-□□) to select a value. Refer to Table 4.3.

Monitor Selection After Power Up: o1-02

User Constant Number	Name	Change during Operation	Setting Range	Unit	Factory Setting	Valid Access Levels	
						Open Loop Vector	Flux Vector
o1-02	Monitor selection after power up		1 to 4	-	1	B	B

- When the power is turned on, the frequency reference will appear in the Unit's data display if the factory settings are being used.
- Any one of the four values monitored at startup (frequency reference, output frequency, output current, or the value set in constant o1-01) can be selected to appear when the power is turned ON.
- Change the setting of constant o1-02 to display an item other than the frequency reference at startup.
- Settings

Setting	Function
1	The frequency reference is displayed at start-up.
2	The output frequency is displayed at start-up.
3	The output current is displayed at start-up.
4	The value set in constant o1-01 is displayed at start-up.

Frequency Units of Reference Setting and Monitor: o1-03

- Set the unit for frequency setting and monitoring.

User Constant Number	Name	Change during Operation	Setting Range	Unit	Factory Setting	Valid Access Levels	
						Open Loop Vector	Flux Vector
o1-03	Frequency units of reference setting and monitor		0 to 39999	-	0	B	B

- Settings

Setting	Unit
0	0.01 Hz
1	0.01%
2 to 39	r/min, 0 to 3999 r/min, 120, frequency reference, Hz, o1-03 number of motor poles
40 to 39999	Use the 5th digit of o1-03 to specify the decimal point. 5th digit = 0: . 5th digit = 1: . 5th digit = 2: . 5th digit = 3: . The 1st to 4th digits of o1-03 determine the frequency setting Ex 1: To set the 100% speed to 200.0, set o1-03 to 12000. 200.0 will be displayed for 100%, 120 will be displayed for 60%. Ex 2: To set the 100% speed to 65.00, set o1-03 to 26500. 65.00 will be displayed for 100%, 39.00 will be displayed for 60%.

Frequency Units of Constant Setting: o1-04

- This constant can be used to change the setting unit for V/f pattern constants to r/min.

User Constant Number	Name	Change during Operation	Setting Range	Unit	Factory Setting	Valid Access Levels	
						Open Loop Vector	Flux Vector
o1-04	Frequency units of constant setting		0 1	-	0		B

- Settings

Setting	Unit
0	Unit of setting: Hz
1	Unit of setting: r/min

Constant Number Display Selection: o1-05

User Constant Number	Name	Change during Operation	Setting Range	Unit	Factory Setting	Valid Access Levels	
						Open Loop Vector	Flux Vector
o1-05	Constant No. display selection		0 1	-	0	A	A

- Settings

Setting	Function
0	Display constant number
1	Display constant number (address) set for MEMOBUS communications

■ Key Function Settings/Other Settings: o2-01 to o2-08

LOCAL/REMOTE Key Enable/Disable: o2-01

User Constant Number	Name	Change during Operation	Setting Range	Unit	Factory Setting	Valid Access Levels	
						Open Loop Vector	Flux Vector
o2-01	LOCAL/REMOTE key enable/disable		0 1	-	1	B	B

- This constant enables or disables the LOCAL/REMOTE Key (the Operation Mode Selector Key) on the Digital Operator.

- Settings

Setting	Function
0	Disabled. (Cannot change between local and remote.)
1	Enabled. (Pressing the LOCAL/REMOTE Key switches control of operation between the Operator and the sources specified in constants b1-01 and b1-02.)

STOP Key During Control Terminal Operation: o2-02

User Constant Number	Name	Change during Operation	Setting Range	Unit	Factory Setting	Valid Access Levels	
						Open Loop Vector	Flux Vector
o2-02	STOP Key during control circuit terminal operation		0 1	-	1	B	B

- This constant enables or disables the STOP on the Digital Operator

- Settings

Setting	Function
0	Disabled. (The STOP Key is disabled when the run command is input from an external terminal.)
1	Enabled. (The STOP Key is enabled at all times during operation.)

User Constant Initial Value: o2-03

User Constant Number	Name	Change during Operation	Setting Range	Unit	Factory Setting	Valid Access Levels	
						Open Loop Vector	Flux Vector
o2-03	User constant initial value		0 to 2	-	0	B	B

- This constant is used to record or clear the user constant defaults.

- Once the user defaults have been recorded, constant A1-03 can be used to initialize the Inverter constants to these defaults.

- Settings

Setting	Function
0	No change. (Retain current settings.)
1	Record user defaults. (Record the current constant settings as user defaults.)
2	Clear user defaults. (Clear the recorded user defaults.)

- The Digital Operator display will return to 0 after the settings have been made.

kVA Selection: o2-04

User Constant Number	Name	Change during Operation	Setting Range	Unit	Factory Setting	Valid Access Levels	
						Open Loop Vector	Flux Vector
o2-04	kVA selection		0 to FF	-	0	B	B

- The setting range and factory setting depend on the Inverter capacity. The settings shown in the table are for a 200 V class, 0.4 kW Inverter. (See page NO TAG.)
- Do not change this constant setting; it is used by the manufacturer to identify the Inverter model.
- Use this setting only the the control PC board has been replaced.

Frequency Reference Setting Method Selection: o2-05

User Constant Number	Name	Change during Operation	Setting Range	Unit	Factory Setting	Valid Access Levels	
						Open Loop Vector	Flux Vector
o2-05	Frequency reference setting method selection		0 1	-	0	A	A

- This constant determines whether it is necessary to press the Enter Key when changing the frequency reference with the Digital Operator's frequency reference monitor; it cannot be changed during operation.
- When o2-05 is set to 1 (DATA/ENTER Key input not required.), the frequency reference changes simultaneously with the Digital Operator's value.

- Settings

Setting	Function
0	DATA/ENTER Key input required.
1	DATA/ENTER Key input not required.

購買、維修 此手冊零組件

電話： 037-466333

Email: service@repairtw.com

Line id: @zzzz

www.repairtw.com

Operation Selection when Digital Operator is Disconnected: o2-06

User Constant Number	Name	Change during Operation	Setting Range	Unit	Factory Setting	Valid Access Levels	
						Open Loop Vector	Flux Vector
o2-06	Operation selection when digital operator is disconnected		0 1	-	0	A	A

- This constant specifies whether to stop operation when the Digital Operator is disconnected.
- Settings

Setting	Function
0	Disable Operator detection. (Continue operation when the Digital Operator is disconnected.)
1	Enable Operator detection. (Detect an OPR fault when the Digital Operator is disconnected, stop the Inverter output, and operate the fault contact.)

Cumulative Operation Time Settings: o2-07 o2-08

User Constant Number	Name	Change during Operation	Setting Range	Unit	Factory Setting	Valid Access Levels	
						Open Loop Vector	Flux Vector
o2-07	Cumulative operation time setting		0 to 65535	h	0	A	A
o2-08	Cumulative operation time selection		0 1	-	0	A	A

- Set the initial elapsed time in constant o2-07. The elapsed operating time will start from this value.
- Constant o2-08 determines whether the elapsed operating time is the time that the Inverter is on or the time that the Inverter is running.
- Settings

Setting	Function
0	Inverter power-on time. (Counts the elapsed time from start-up until power is turned off.)
1	Inverter running time. (Counts the elapsed time that there is an Inverter output.)

上正科技有限公司

購買、維修 此手冊零組件

電話： 037-466333

Email: service@repairtw.com

Line id: @zzzz

www.repairtw.com

7.4 Optional Functions

7.4.1 Winding Change Function

Winding change motors can be connected in two different ways, Y (low speed) - and (high speed) - windings.

The base frequency of the Y-winding is lower than that of Δ -winding, providing higher torque at low speeds. For the Δ -winding, high speeds are possible.

By switching between the two winding connections, a wide constant power range can be obtained, beneficial for driving the spindle of a lathe or a milling machine.

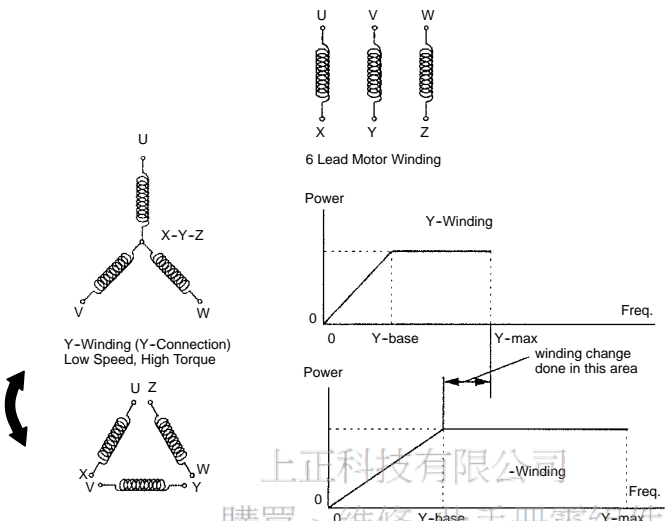

Fig. 7.34 Y- and Δ -Windings

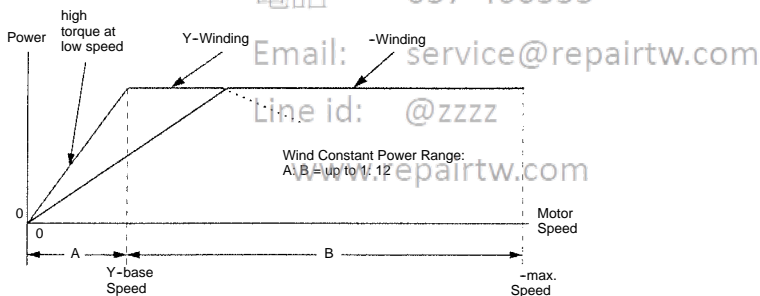
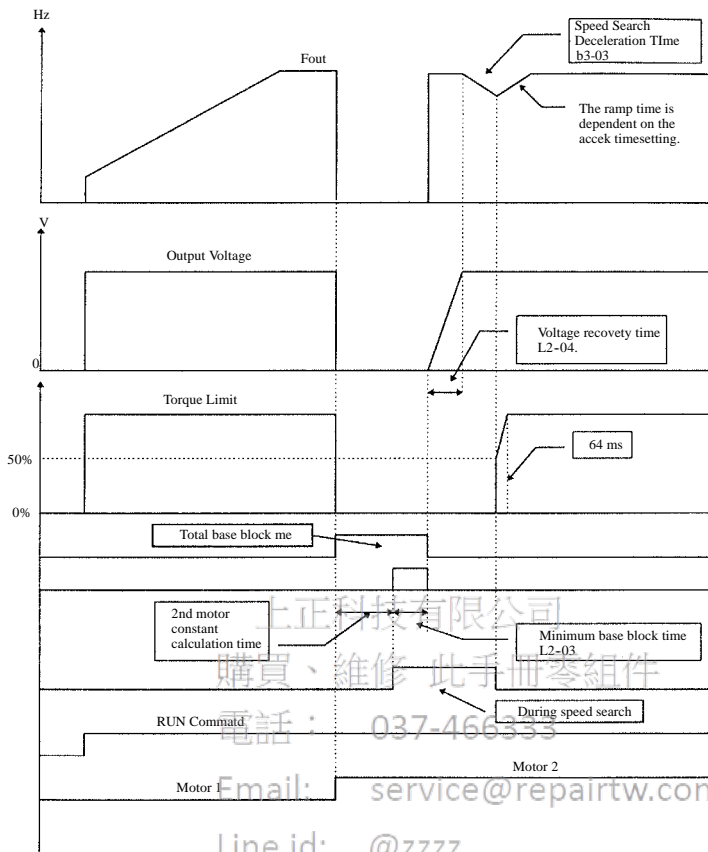

Fig. 7.35 Output Performance of Winding Change

Fig 7.36 shows motor constant change sequence during winding change.



Note When the flux vector control mode is selected, the torque reference increases from zero within 64msec.
(For open loop vector mode, torque reference increases 50% of the torque limit.)

Fig 7.36 Winding Change Sequence

- When selecting a motor for winding change application with a MC5 drive, it is necessary to check the base and maximum frequencies, no-load voltage at base and maximum frequencies, leak inductance, full load rated current, etc. for both Y- and Δ -windings.
- Heavy cutting during winding change may cause the winding change to malfunction and/or stall the system.

Minimum Baseblock Time: L2-03

User Constant Number	Name	Change during Operation	Setting Range	Unit	Factory Setting	Valid Access Levels	
						Open Loop Vector	Flux Vector
L2-03	Min. baseblock time		0.0 to 5.0	s	0.5	B	B

- The factory setting depends on the Inverter capacity. The factory setting shown in the table is for a 200 V class, 0.4 kW Inverter. (See page NO TAG.)
- This setting is used with the speed search and DC injection braking functions.
- Set the time required for the leakage voltage to dissipate. Increase the setting if an overcurrent (OC) occurs when the speed search or DC injection braking function starts.
- Set the baseblock time during winding change. Time for winding change varies according to the setting. (For example, lower the setting, and time for winding change is also reduced.) Overcurrent (OC) might occur if setting is too low.
- This setting is valid for speed searches performed after a momentary power loss and regular speed searches.

Voltage Recovery Time: L2-04

User Constant Number	Name	Change during Operation	Setting Range	Unit	Factory Setting	Valid Access Levels	
						Open Loop Vector	Flux Vector
L2-04	Voltage recovery time		0.0 to 5.0	s	0.3	A	A

- Set the time allowed for the normal voltage to be restored after completion of the speed search. For a 200 V class Inverter, this is the time in seconds for voltage to be restored from 0 VAC to 200 VAC. For a 400 V class Inverter, this is the time in seconds for voltage to be restored from 0 VAC to 400 VAC.
- This setting is valid for speed searches after a momentary power loss, regular speed searches, the voltage changes with energy-saving control, and the voltage changes with baseblock clearing.
- Set the voltage recovery time after baseblock during winding change. Overvoltage (OV) might occur if setting is too low.

Speed Search Deceleration Time: b3-03

User Constant Number	Name	Change during Operation	Setting Range	Unit	Factory Setting	Valid Access Levels	
						Open Loop Vector	Flux Vector
b3-03	Speed search deceleration time		0.1 10.0	s	2.0	A	

- Set output frequency deceleration time during speed search. (Set the time to decelerate from the max. output frequency to 0Hz.)

7.4.2 Wiring for Winding Change

The VS-626MCS offers two different types of winding changes, external winding change and auto-winding change. W-winding and -winding can be set independently using constants for motor 1 and 2.

External Winding Change Method

In this method, an external signal is given to one of the multi-function inputs (set as "80H") to start the winding change. The external signal is given from the CNC.

MC Answerback error detection: P1-03

User Constant Number	Name	Change during Operation	Setting Range	Unit	Factory Setting	Valid Access Levels	
						Open Loop Vector	Flux Vector
P1-03	MC Answerback error detection		0.20 to 1.00	sec	0.20	A	A

- This constant determines the waiting time for the MC (Magnetic Contactor) answerback error detection.
- Setting is valid when one of the multi-function digital inputs (H1-01 to H1-06) has been set to 81 or 82.

Motor constant selection: P1-04

User Constant Number	Name	Change during Operation	Setting Range	Unit	Factory Setting	Valid Access Levels	
						Open Loop Vector	Flux Vector
P1-04	Motor constant selection		0 1	-	1	A	A

- Select the motor constants allocated for the types of winding to be used.

- Settings

Setting	Function
0	Motor 1 constants (E1, E2) are used for Y-winding, and motor 2 constants (E3, E4, E5) are used for -winding
1	Motor 2 constants (E3, E4, E5) are used for Y-winding, and motor 2 constants (E1, E2) are used for -winding

Fig 7.37 shows a wiring example of external winding change.

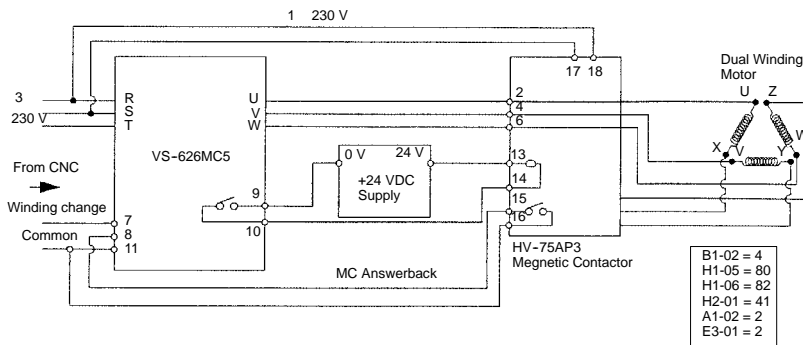

Fig 7.37 Sample Wiring for External Wiring Change (Open Loop Vector Control Mode)

- To use the external winding change method, set the multi-function digital input used for receiving the winding change signal to "80." This setting enables the selection of Motor 1 constants (E1 and E2) when the input is open and Motor 2 constants (E4 and E5) when the input is closed.
- When using the external winding change method, Auto-Winding constants (P1-01 and P1-02) are not valid.

■ Auto-Winding Change Method

This method can be used when the multi-function digital input is not set to "80."

The selection of the motor 1 and motor 2 is conducted internally by preset constants, such as winding change frequency (P1-01) and winding change hysteresis (P1-02).

Winding change frequency: P1-01

User Constant Number	Name	Change during Operation	Setting Range	Unit	Factory Setting	Valid Access Levels	
						Open Loop Vector	Flux Vector
P1-01	Winding change frequency		0.0 to 400.0	Hz	0.0	A	A

- Sets winding change frequency when auto-winding change method is used. Set P1-01 lower than the max. frequency of the Y-winding.

Winding change hysteresis: P1-02

User Constant Number	Name	Change during Operation	Setting Range	Unit	Factory Setting	Valid Access Levels	
						Open Loop Vector	Flux Vector
P1-02	Winding change hysteresis		0.0 to 20.0	-	5.0	A	A

- Sets the hysteresis of the winding change frequency.

MC Answerback error detection: P1-03

User Constant Number	Name	Change during Operation	Setting Range	Unit	Factory Setting	Valid Access Levels	
						Open Loop Vector	Flux Vector
P1-03	MC Answerback error detection		0.20 to 1.00	sec	0.20	A	A

- This constant determines the waiting time for the MC (Magnetic Contactor) answerback error detection. Constant setting is valid when one of the multi-function digital inputs (H1-01 to H1-06) has been set to 81 or 82.

Motor constant selection: P1-04

User Constant Number	Name	Change during Operation	Setting Range	Unit	Factory Setting	Valid Access Levels	
						Open Loop Vector	Flux Vector
P1-04	Motor constant selection		0 1	-	1	A	A

- Select the motor constants allocated for the types of winding to be used.

• Settings

Setting	Function
0	Motor 1 constants (E1 E2) are used for Y-winding, and motor 2 constants (E3 E4 E5) are used for -winding
1	Motor 2 constants (E3 E4 E5) are used for Y-winding, and motor 2 constants (E1 E2) are used for -winding

Figure 7.38 shows a wiring example of auto-winding change

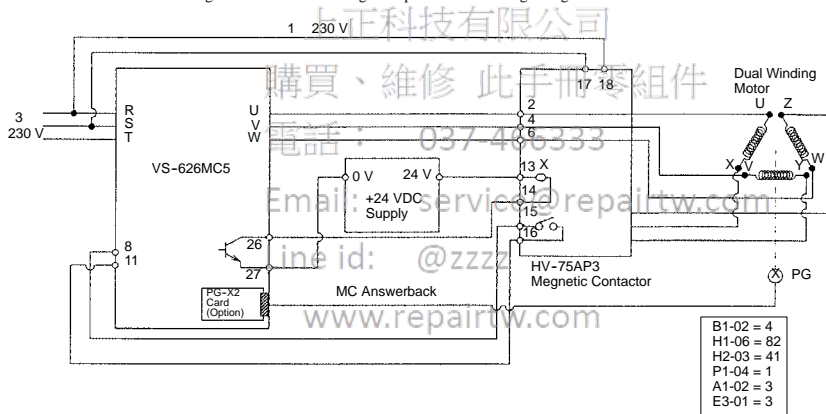

Fig 7.38 Sample Wiring for Auto-winding Change

Figure 7.39 shows the sequence of auto-winding change method.

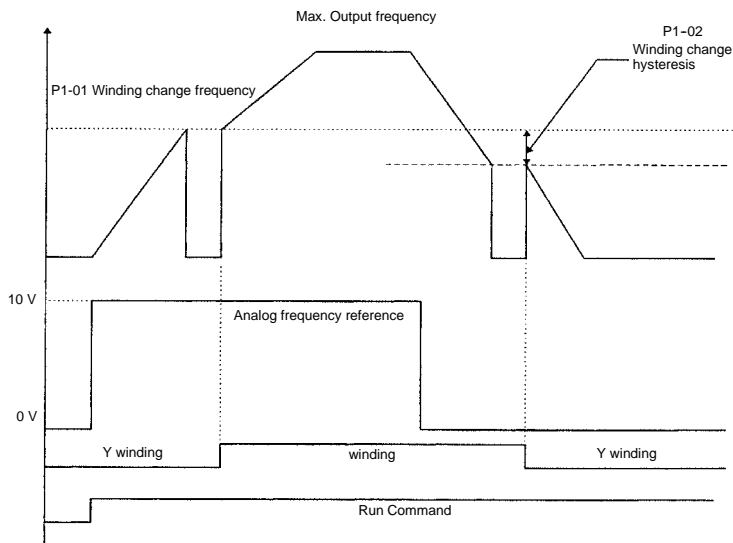

Fig 7.39 Auto-winding change sequence

7.4.3 Setting/Adjusting the Winding Change Constants

■ Winding Change Constants: P1-01 to P1-05

Winding change frequency: P1-01

User Constant Number	Name	Change during Operation	Setting Range	Unit	Factory Setting	Valid Access Levels	
						Open Loop Vector	Flux Vector
P1-01	Winding change frequency	0.0 to 400.0	Hz	0.0	A	A	

- Sets winding change frequency when auto-winding change method is used. Set P1-01 lower than the max. frequency of the Y (low speed) winding.

Winding change hysteresis: P1-02

User Constant Number	Name	Change during Operation	Setting Range	Unit	Factory Setting	Valid Access Levels	
						Open Loop Vector	Flux Vector
P1-02	Winding change hysteresis	0.0 to 20.0	-	5.0	A	A	

- Sets the hysteresis of the winding change frequency.

MC Answerback error detection: P1-03

User Constant Number	Name	Change during Operation	Setting Range	Unit	Factory Setting	Valid Access Levels	
						Open Loop Vector	Flux Vector
P1-03	MC Answerback error detection		0.20 to 1.00	sec	0.20	A	A

- This constant determines the waiting time for the MC (Magnetic Contactor) answerback error detection. Constant setting is valid when one of the multi-function digital input constants (H1-01 to H1-06) has been set to 81 or 82.

Motor constant selection: P1-04

User Constant Number	Name	Change during Operation	Setting Range	Unit	Factory Setting	Valid Access Levels	
						Open Loop Vector	Flux Vector
P1-04	Motor constant selection		0 1	-	1	A	A

- Select the motor constants allocated for the types of winding to be used.

• Settings

Setting	Function
0	Motor 1 constants (E1 E2) are used for Y-winding, and motor 2 constants (E3 E4 E5) are used for -winding
1	Motor 2 constants (E3 E4 E5) are used for Y-winding, and motor 2 constants (E1 E2) are used for -winding

Programming mode valid/invalid during run: P1-05

User Constant Number	Name	Change during Operation	Setting Range	Unit	Factory Setting	Valid Access Levels	
						Open Loop Vector	Flux Vector
P1-05	Programming mode valid/invalid during run		0 1	-	1	A	A

• Settings

Setting	Function
0	Disabled
1	Enabled

- When set to 1, it is possible to select programming mode by pressing MENU or ESC key. Motor coast to a stop when winding change is performed while in programming mode.
- If set to 0, stopping during a free run can be prevented, but the program mode cannot be selected while running.

電話： 037-466333

Email: service@repairtw.com

Line id: @zzzz

www.repairtw.com

8

User Constants

This chapter lists all user constants that can be used in the Programming and Initialize modes.

8.1	Initialize Mode Constants	8 - 3
8.2	Programming Mode Constants	8 - 4
8.2.1	Application Constants: b	8 - 4
8.2.2	Autotuning Constants: C	8 - 7
8.2.3	Reference Constants: d	8 - 12
8.2.4	Motor Constant Constants: E	8 - 14
8.2.5	Options Constants: F	8 - 18
8.2.6	Terminal Constants: H	8 - 21
8.2.7	Protection Constants: L	8 - 26
8.2.8	Operator Constants: o	8 - 32
8.2.9	Winding Change Constants: P	8 - 34
8.2.10	Factory Settings that Change with the Control Method (A1-02)	8 - 35
8.2.11	Factory Settings that Change with the Inverter Capacity (o2-04)	8 - 36

上海科特有限公司
購買、維修、培訓、零件
電話：037-466333

Email: service@repairtw.com

Line id: @zzzz

www.repairtw.com

■ User Constant Descriptions

Constant Number	Name	Description	Setting Range	Factory Setting	Change during Operation	Control Methods		Page
	Display					Open Loop Vector	Flux Vector	
A1-00	Language selection for digital operator display	Used to select the language displayed on the Digital Operator 0: English 1: Japanese	0 1	1		Q	Q	- 19
	Select Language	This constant is not changed by the initialize operation.						

- **Constant Number:** The constant number.
- **Name:** The constant name.
- **Display:** The constant name displayed on the Digital Operator.
- **Description:** Details of the constant function or setting value.
- **Setting Range:** The constant setting range.
- **Factory Setting:** The factory setting value (each control method has its own factory setting. Therefore the factory setting changes when the control method is changed.)
See page - 34 for factory settings by control method.
- **Change during Operation:** Indicates whether or not the constant can be changed while in the Inverter is in operation.
Changes possible during operation.
Changes not possible during operation.
- **Control Method:** Indicates which control methods and which access levels can be set and referenced.
Q Items which can be set and referenced in Quick-Start only.
B Items which can be set and referenced in Quick-Start and Basic.
A Items which can be set and referenced on all access levels; Quick-Start, Basic, and Advanced.
Items which cannot be set or referenced in that control method.
- **Page:** Reference page for more detailed information on the constant.

上正科技有限公司

購買、維修 此手冊零組件

電話： 037-466333

Email: service@repairtw.com

Line id: @zzzz

www.repairtw.com

8.1 Initialize Mode Constants

Constant Number	Name		Description	Setting Range	Factory Setting	Change during Operation	Control Methods		Page
	Display						Open Loop Vector	Flux Vector	
A1-00	Language selection for digital operator display		Used to select the language displayed on the Digital Operator 0: English 1: Japanese This constant is not initialized by the initialize operation.	0 1	1		Q	Q	- 19
	Select Language								
A1-01	Constant access level		Used to set the constant access level (set/read.) 0: Monitoring only (Displays only Operation mode and Initialize mode) 1: Used to select user constant (Constants A2-01 to A2-32 only can be set/read.) 2: Quick-Start : Q 3: Basic : B 4: Basic : A	0 to 4	2		Q	Q	- 19
	Access Level								
A1-02	User setting constant		Used to select the control method for the Inverter 2: Open loop vector 3: Flux vector This constant is not initialized by the initialize operation.	2 3	2		Q	Q	- 20
	User Param 1 to 32								
A1-03	Initialize		Used to initialize the constants using the specified method. 0: No initializing 1110: Initializes using the User constants 2220: Initializes using a two-wire sequence. (Initializes to the factory setting.) 3330: Initializes using a three-wire sequence.	0 to 3330	0		Q	Q	- 21
	Init Constants								
A1-04	Password 1		Password input when a password has been set in A1-05. This function write-protects some constants of the Initialize mode. If the password is changed, A1-01 to A1-03 and A2-01 to A2-32 constants can no longer be changed. (Programming mode constants can be changed.)	0 to 9999	0		Q	Q	- 23
	Enter Password								
A1-05	Password 2		Used to set a four digit number as the password. This constant is not usually displayed. When the password (A1-04) is displayed, hold down the Reset/Select Key and press the Menu Key and the password will be displayed.	0 to 9999	0		Q	Q	- 23
	Select Password								
A2-01 to A2-32	User setting constant		Used to set the constant numbers that can be set/read. Maximum 32. Effective when the access level (A1-01) is set to User Program (1). Constants set in constants A2-01 to A2-32 can be set/read in the Programming mode.	b1-01 to o2-08	--		A	A	- 23
	User Param 1 to 32								

8.2 Programming Mode Constants

8.2.1 Application Constants: b

■ Operation Mode Selections: b1

Constant Number	Name	Description	Setting Range	Factory Setting	Change during Operation	Control Methods		Page
	Display					Open Loop Vector	Flux Vector	
b1-01	Reference selection	Used to set the input method for the frequency reference. 0: Digital Operator 1: Control circuit terminals (analog inputs).	0 to 3	1		Q	Q	- 4 - 7
	Reference Source	2: Transmission 3: Option Card						
b1-02	Operation method selection	Used to set the source of the run command. 0: Digital Operator 1: Control circuit terminals (sequence inputs). 2: Transmission	0 to 5	1		Q	Q	- 9
	Run Source	3: Option Card 4: MEMOBUS transmission (for CP-717) 5: Winding change sequence						
b1-03	Stopping method selection	Used to set the stopping method used when a stop command is input.	0	0		Q	Q	- 12
	Stopping Method	0: Ramp to stop						
b1-04	Prohibition of reverse operation	0: Reverse enabled	0	0		B	B	- 11
	Reverse Oper							
b1-05	Operation selection for setting of E1-09 or less	Used to set the method of operation when the frequency reference input is less than the minimum output frequency (E1-09). 0: Run at frequency reference (E1-09 not effective). 1: STOP (Frequencies below E1-09 in the coast to stop state.) 2: Run at min. frequency. (E1-09) 3: Run at zero speed (Frequencies below E1-09 are zero) This function is only available in with flux vector control.	0 to 3	0			A	- 25
	Zero-Speed Oper							
b1-06	Read sequence input twice	Used to set the responsiveness of the control inputs (forward/reverse and multi-function inputs.) 0: Two scans every 2 ms (Use when connecting transistor outputs.) 1: One scan.	0 to 1	1		A	A	- 9
	Cntl Input Scans	1: Two scans every 5 ms (Use when connecting contact outputs or switches.)						
b1-07	Operation selection after switching to remote mode	Used to set the Operation mode by switching to the Remote mode using the Local/Remote Key. 0: Run signals that are input during mode switching are disregarded. (Input Run signals after switching the mode.) 1: Run signals become effective immediately after switching to the Remote mode.	0 to 1	0		A	A	- 9
	LOC/REM RUN Sel							

Constant Number	Name	Description	Setting Range	Factory Setting	Change during Operation	Control Methods		Page
	Display					Open Loop Vector	Flux Vector	
b1-08	Run command selection in PRG mode	Used to set the Operation mode in program mode. 0: Can operate. 1: Cannot operate (Disabled when Digital Operator selects run command (when b1-02 = 0).	0 1	0		A	A	--
	RUN CMD at PRG							

■ DC Braking: b2

Constant Number	Name	Description	Setting Range	Factory Setting	Change during Operation	Control Methods		Page
	Display					Open Loop Vector	Flux Vector	
b2-01	Zero speed level (DC injection braking starting frequency)	Used to set the frequency which starts DC injection braking (the initial excitation for flux vector control) in units of 0.1 Hz when deceleration to stop is selected. When b2-01 is less than E1-09, E1-09 becomes the DC injection braking starting frequency. Only with flux vector control is b2-01 used.	0.0 to 10.0	0.5		B	B	- 18 - 26
	DCinj Start Freq							
b2-02	DC injection braking current	Sets the DC injection braking current as a percentage of the Inverter rated current. The initial excitation current for flux vector control depends on the E2-03 setting.	0 to 100	50		B		- 18
	DCinj Current							
b2-03	DC injection braking time at start	Used to set the time to perform DC injection braking (initial excitation for flux vector control) at start in units of 1 second. Used to stop coasting motor and restart it. When the set value is 0, DC injection braking at start is not performed.	0.00 to 10.00	0.00		B	B	- 18 - 19 - 26
	DCinj Time @ Start							
b2-04	DC injection braking time at stop	Used to set the time to perform DC injection braking (initial excitation for flux vector control) at stop in units of 1 second. Used to prevent coasting after the stop command is input. When the set value is 0.00, DC injection braking at stop is not performed.	0.00 to 10.00	0.50		B	B	- 18 - 26
	DCinj Time @ Stop							
b2-08	Magnetic flux compensation volume	Used to set the magnetic flux compensation in % units, with the no-load current as 100%.	0 to 500	0		A	A	- 19
	Field Comp @ Start							

Line id: @zzzz

www.repairtw.com

■ Speed Search: b3

Constant Number	Name	Description	Setting Range	Factory Setting	Change during Operation	Control Methods		Page
	Display					Open Loop Vector	Flux Vector	
b3-01	Speed search selection at start	Sets the speed search function to start when the run command is input. 0: Disabled (Starts from the minimum output frequency.) 1: Enabled (Speed search is started from the maximum frequency. In a control method with PG, the motor starts at the frequency of motor rotation when the run command is input.)	0 1	0 *		A	A	- 20
	SpdSrch at Start							
b3-02	Speed search operating current	Sets the speed search operation current as a percentage of the Inverter rated current. Not usually necessary to set. When restarting is not possible with the set value, reduce the value.	0 to 200	100		A		- 20
	SpdSrch Current							
b3-03	Speed search deceleration time	Sets the output frequency deceleration time during speed search in 1-second units. Set the time for deceleration from the maximum output frequency to 0 Hz.	0.1 to 10.0	2.0		A		- 20
	SpdSrch Dec Time							

* When the control method is changed, the Inverter reverts to factory settings. (The open loop vector control factory settings will be displayed.)

上正科技有限公司

購買、維修 此手冊零組件

電話： 037-466333

Email: service@repairtw.com

Line id: @zzzz

www.repairtw.com

8.2.2 Autotuning Constants: C

■ Acceleration/Deceleration: C1

Constant Number	Name	Description	Setting Range	Factory Setting	Change during Operation	Control Methods		Page									
	Display					Open Loop Vector	Flux Vector										
C1-01	Acceleration time 1	Sets the acceleration time to accelerate from 0 to the maximum output frequency, in 1-second units.	0.0 to 6000.0 *	10.0		Q	Q	-10 -16									
	Accel Time 1																
C1-02	Deceleration time 1	Sets the deceleration time to decelerate from the maximum output frequency to 0, in 1-second units.							Q	Q	-10 -16						
	Decel Time 1																
C1-03	Acceleration time 2	The acceleration time when the multi-function input "accel/decel time 1" is set to ON.							B	B	-10 -16						
	Accel Time 2																
C1-04	Deceleration time 2	The deceleration time when the multi-function input "accel/decel time 1" is set to ON.										B	B	-10 -16			
	Decel Time 2																
C1-05	Acceleration time 3	The acceleration time when the multi-function input "accel/decel time 2" is set to ON.										A	A	-10 -16			
	Accel Time 3																
C1-06	Deceleration time 3	The deceleration time when the multi-function input "accel/decel time 2" is set to ON.													A	A	-10 -16
	Decel Time 3																
C1-07	Acceleration time 4	The acceleration time when the multi-function input "accel/decel time 1" and "accel/decel time 2" are set to ON.										A	A	-10 -16			
	Accel Time 4																
C1-08	Deceleration time 4	The deceleration time when the multi-function input "accel/decel time 1" and "accel/decel time 2" are set to ON.													A	A	-10 -16
	Decel Time 4																
C1-09	Emergency stop time	The deceleration time when the multi-function input "Emergency (fast) stop" is set to ON.										B	B	-10 -16			
	Fast Stop Time	This function can be used a stopped method when a fault has been detected.															
C1-10	Accel/decel time setting unit	0: 0.01-second units										0.1	-1		A	A	-10
	Acc/Dec Units	1: 0.1-second units															
C1-11	Accel/decel time switching frequency	Sets the frequency for automatic acceleration/deceleration switching. Below set frequency: Accel/decel time 4 Above set frequency: Accel/decel time 1							0.0 to 400.0	0.0					A	A	-11
	Acc/Dec SW Freq	The multi-function input "accel/decel time 1" or "accel/decel time 2" take priority.															

* The setting range for acceleration/deceleration times will differ according to the setting for C1-10 (the unit for acceleration/deceleration time.) When C1-10 is set to 0, the setting range for acceleration/deceleration times becomes 0.00 to 600.00 seconds.

■ S-curve Acceleration/Deceleration: C2

Constant Number	Name		Description	Setting Range	Factory Setting	Change during Operation	Control Methods		Page
	Display						Open Loop Vector	Flux Vector	
C2-01	S-curve characteristic time at acceleration start		<p>All sections of the S-curve characteristic time are set in seconds units.</p> <p>When the S-curve characteristic time is set, the accel/decel times will increase by only half of the S-curve characteristic times at start and end.</p>	0.0 to 2.50	0.20		A	A	- 21
	SCrv Acc @ Start								
C2-02	S-curve characteristic time at acceleration end			0.0 to 2.50	0.20		A	A	- 21
	SCrv Acc @ End								
C2-03	S-curve characteristic time at deceleration start		0.00 to 2.50	0.20		A	A	- 21	
	SCrv Dec @ Start								
C2-04	S-curve characteristic time at deceleration end		0.00 to 2.50	0.00		A	A	- 21	
	SCrv Dec @ End								

■ Motor Slip Compensation: C3

Constant Number	Name		Description	Setting Range	Factory Setting	Change during Operation	Control Methods		Page
	Display						Open Loop Vector	Flux Vector	
C3-01	Slip compensation gain		<p>Used to improve speed accuracy when operating with a load.</p> <p>Usually setting is not necessary. When actual speed is low, increase the set value. When actual speed is high, decrease the set value.</p> <p>In flux vector control mode this function becomes gain to compensate for slip caused by temperature variation.</p>	0.0 to 2.5	1.0 *		B	B	- 15 - 22
	Slip Comp Gain								
C3-02	Slip compensation primary delay time		<p>Slip compensation primary delay time is set in ms units.</p> <p>Usually setting is not necessary. Adjust when slip compensation responsiveness is low, or speed is not stabilized.</p> <p>When responsiveness is low, decrease the set value.</p> <p>When speed is not stabilized, increase the set value.</p>	0 to 10000	200 *		A		- 22
	Slip Comp Time								
C3-03	Slip compensation limit		Sets the slip compensation limit as a percentage of motor rated slip.	0 to 250	200		A		- 22
	Slip Comp Limit								
C3-04	Slip compensation selection during regeneration		<p>0: Disabled.</p> <p>1: Enabled.</p> <p>When the slip compensation during regeneration function has been activated, as regeneration capacity increases momentarily, it may be necessary to use a braking option (braking resistor, Braking Resistor Unit or Braking Unit.)</p>	0 1	0		A		- 23
	Slip Comp Regen								
C3-05	Flux calculation method		<p>Used to set the flux calculation method.</p> <p>0: Flux is calculated based on the output frequency after compensation.</p> <p>1: Flux is calculated based on the output frequency before compensation.</p>	0 1	0		A		--
	Flux Select								

Constant Number	Name	Description	Setting Range	Factory Setting	Change during Operation	Control Methods		Page
	Display					Open Loop Vector	Flux Vector	
C3-06	Output voltage limited operation selection	0: Disabled 1: Enabled (The motor magnetic flux automatically decreases when output voltage is saturated.)	0 1	0		A	A	- 8
	Output V Limit							

* When the control method is changed, the Inverter reverts to factory settings. (The open loop vector control factory settings will be displayed.)

■ Torque Compensation: C4

Constant Number	Name	Description	Setting Range	Factory Setting	Change during Operation	Control Methods		Page
	Display					Open Loop Vector	Flux Vector	
C4-01	Torque compensation gain	Sets torque compensation gain as a ratio. Usually setting is not necessary. Adjust in the following circumstances: • When the cable is long; increase the set value. • When the motor capacity is smaller than the inverter capacity (Max. applicable motor capacity), increase the set values. • When the motor is oscillating, decrease the set values.	0.00 to 2.50	1.00		B		- 23
	Torq Comp Gain	Adjust the output current range at minimum speed rotation so that it does not exceed the inverter rated output current.						
C4-02	Torque compensation time constant	The torque compensation delay time is set in ms units. Usually setting is not necessary. Adjust in the following circumstances: • When the motor is oscillating, increase the set values. • When the responsiveness of the motor is low, decrease the set values.	0 to 10000	20 *		A		- 23
	Torq Comp Time							
C4-03	Start torque compensation (forward rotation) F TorqCmp @ Start	Sets start torque compensation with the motor's rated torque at 100%.	0 to 200	0.0		A		- 9
C4-04	Start torque compensation (reverse rotation)	Sets start torque compensation with the motor's rated torque at 100%.	-200.0 to 0.0	0.0		A		- 9
	R TorqCmp @ Start							
C4-05	Start torque constant	Sets start torque constant in ms units. When set to 0 to 4 ms, the filter will be invalid.	0 to 200	10		A		- 9
	TorqCmp Delay T							

* When the control method is changed, the Inverter reverts to factory settings. (The open loop vector control factory settings will be displayed.)

■ Speed Control (ASR): C5

Constant Number	Name		Description	Setting Range	Factory Setting	Change during Operation	Control Methods		Page
	Display						Open Loop Vector	Flux Vector	
C5-01	ASR proportional (P) gain 1		Sets the proportional gain of the speed loop (ASR.)	0.00 to 300.00	20.00 *			B	- 32
	ASR P Gain 1								
C5-02	ASR integral (I) time 1		Sets the integral time of the speed loop (ASR) in 1-second units.	0.000 to 10.000	0.500 *			B	- 32
	ASR I Time 1								
C5-03	ASR proportional (P) gain 2		Usually setting is not necessary. Set to change the rotational speed gain.	0.00 to 300.00	20.00 *			B	- 32
	ASR P Gain 2								
C5-04	ASR integral (I) time 2			0.000 to 10.000	0.500 *			B	- 32
	ASR I Time 2								
C5-06	ASR primary delay time		Sets the filter time constant; the time from the speed loop to the torque command output, in units of 1-second. Usually setting is not necessary.	0.000 to 0.500	0.004			A	- 33
	ASR Delay Time								
C5-07	ASR switching frequency		Sets the frequency for switching between Proportion Gain 1, 2 and Integral Time 1, 2 in Hz units. The multi-function input "ASR Gain SW" takes priority.	0.0 to 400.0	0.0			A	- 32
	ASR Gain SW Freq								
C5-08	ASR integral (I) limit		Set to a small value to prevent any radical load change. Set to 100% of the maximum output frequency.	0 to 400	400			A	--
	ASR I Limit								

* The factory setting will change when the control method is changed. (The open loop vector control factory settings are given.)

■ Carrier Frequency: C6

Constant Number	Name		Description	Setting Range	Factory Setting	Change during Operation	Control Methods		Page	
	Display						Open Loop Vector	Flux Vector		
C6-01	Carrier Frequency Upper Limit		Set the carrier frequency upper limit in kHz units.	2.0 to 15.0 %	15.0			B	B	- 24
	Carrier Freq Max									

* 1. The setting range and the factory setting of the Inverter will differ depending on its capacity and control method. (The value for the 200 V class 0.4 kW Inverter in open loop vector control mode is given.) (See page - 35.)

* 2. For a 400 V Inverter, if the carrier frequency is set to a value higher than the factory setting, the Inverter overload "OL2" detection value will decrease.

■ Factory Tuning: C8

Constant Number	Name	Description	Setting Range	Factory Setting	Change during Operation	Control Methods		Page
	Display					Open Loop Vector	Flux Vector	
C8-08	AFR gain	Sets the internal speed feedback detection control section as a ratio. Usually setting is not necessary. Adjust in the following circumstances: <ul style="list-style-type: none"> When hunting occurs, increase the set values. When responsiveness is low, decrease the set values. Change the responsiveness in 0.05 units at a time, checking after each change.	0.00 to 10.00	1.00		A		- 5
	AFR Gain							
C8-09	Speed feedback detection control (ARF) time	<ul style="list-style-type: none"> Increase setting if hunting occurs. Decrease setting if response is poor. 	0 to 2000	50		A		--
	AFR Time							
C8-30	Carrier frequency selection during auto-tuning	0: Carrier frequency is set to 2.0 kHz. 1: Carrier frequency is set to a value as set in C6-01. 2: Carrier frequency is set to 5 kHz.	0 to 2	2		A		--
	Carrier in tune							

8.2.3 Reference Constants: d

■ Preset Reference: d1

Constant Number	Name	Description	Setting Range	Factory Setting	Change during Operation	Control Methods		Page
	Display					Open Loop Vector	Flux Vector	
d1-01	Frequency reference 1	Sets the frequency reference in the units used in 01-03 (frequency reference display/set units.) The factory setting unit for 01-03 is Hz.		0.00		Q	Q	- 8
	Reference 1							
d1-02	Frequency reference 2	The frequency reference when the multi-function input "multi-step speed reference 1" is ON.		0.00		Q	Q	- 8
	Reference 2							
d1-03	Frequency reference 3	The frequency reference when the multi-function input "multi-step speed reference 2" is ON.		0.00		Q	Q	- 8
	Reference 3							
d1-04	Frequency reference 4	The frequency reference when the multi-function input "multi-step speed reference 1, 2" is ON.		0.00		Q	Q	- 8
	Reference 4							
d1-05	Frequency reference 5	The frequency reference when the multi-function input "multi-step speed reference 2" is ON.	0 to 400.00	0.00		B	B	- 8
	Reference 5							
d1-06	Frequency reference 6	The frequency reference when the multi-function input "multi-step speed reference 1, 3" is ON.		0.00		B	B	- 8
	Reference 6							
d1-07	Frequency reference 7	The frequency reference when the multi-function input "multi-step speed reference 2, 3" is ON.		0.00		B	B	- 8
	Reference 7							
d1-08	Frequency reference 8	The frequency reference when the multi-function input "multi-step speed reference 1, 2, 3" is ON.		0.00		B	B	- 8
	Reference 8							
d1-09	Jog frequency reference	The frequency reference when the multi-function inputs, "Jog frequency reference selection," "FJOG command," and "RJOG command" are ON.		6.00		Q	Q	- 8
	Jog Reference							

■ Reference Limits: d2

Constant Number	Name	Description	Setting Range	Factory Setting	Change during Operation	Control Methods		Page
	Display					Open Loop Vector	Flux Vector	
d2-01	Frequency reference upper limit	Sets the output frequency upper limit as a percentage of the maximum output frequency.	0.0 to 110.0	100.0		B	B	- 24
	Ref Upper Limit							
d2-02	Frequency reference lower limit	Sets the output frequency lower limit as a percentage of the maximum output frequency.	0.0 to 109.0	0.0		B	B	- 24
	Ref Lower Limit							

■ Jump Frequencies: d3

Constant Number	Name	Description	Setting Range	Factory Setting	Change during Operation	Control Methods		Page
	Display					Open Loop Vector	Flux Vector	
d3-01	Jump frequency 1	Set the center values of the jump frequencies in Hz. This function is disabled by setting the jump frequency to 0 Hz. Always ensure that the following applies: $d3-01 \neq d3-02 \neq d3-03$ Operation in the jump frequency range is prohibited but during acceleration and deceleration, speed changes smoothly without jump.	0.0 to 400.0	0.0		B	B	- 25
	Jump Freq 1							
d3-02	Jump frequency 2							
	Jump Freq 2							
d3-03	Jump frequency 3	0.0		B	B	- 25		
	Jump Freq 3							
d3-04	Jump frequency width	Sets the jump frequency bandwidth in Hz. The jump frequency will be the jump frequency \pm d3-04.	0.0 to 20.0	1.0		B	B	- 25
	Jump Bandwidth							

■ Reference Frequency Hold: d4

Constant Number	Name	Description	Setting Range	Factory Setting	Change during Operation	Control Methods		Page
	Display					Open Loop Vector	Flux Vector	
d4-01	Frequency reference hold function selection	Sets whether or not frequencies or hold will be recorded. 0: Disabled (when operation is stopped or the power is turned on again starts at 0.) 1: Enabled (when operation is stopped or the power is turned on again starts at the previous hold frequency). This function is available when the multi-function inputs "accel/ decel Ramp Hold" or "up/down" commands are set.	0 1	0		A	A	- 25
	MOP Ref Memory							
d4-02	+ - Speed limits	Sets the increase/decrease frequency for analog frequency references as a percentage of the maximum output frequency. This function is available when the multi-function inputs "Trim Clt Increase" or "Trim Clt Decrease" is set.	0 to 100.	25		A	A	- 26
	Trim Control Lvl							

8.2.4 Motor Constant Constants: E

■ V/f Pattern: E1

Constant Number	Name		Description	Setting Range	Factory Setting	Change during Operation	Control Methods		Page
	Display						Open Loop Vector	Flux Vector	
E1-01	Input voltage setting		Sets the Inverter input voltage in units of 1 V. This setting is used as the reference value for functions such as the protection functions.	155 to 255 *1	200 *1		Q	Q	- 17 - 27
	Input Voltage								
E1-02	Motor selection		0: Standard fan-cooled motor (general-purpose motor) 1: Standard blower-cooled motor (Inverter-exclusive motor) 2: Special motor (vector-exclusive motor) This setting is used as the reference value for functions such as the protection functions.	0 to 2	0		Q	Q	- 17 - 27
	Motor Selection								
E1-04	Max. output frequency		<p>Output voltage (V)</p> <p>VMAX E1-05 VBASE E1-13 VC E1-08 VMIN E1-10</p> <p>FMIN E1-09 FB E1-07 FA E1-06 FMAX E1-04</p>	40.0 to 400.0	60.0		Q	Q	- 5 - 12
	Max Frequency								
E1-05	Max. voltage		<p>Output voltage (V)</p> <p>VMAX E1-05 VBASE E1-13 VC E1-08 VMIN E1-10</p> <p>FMIN E1-09 FB E1-07 FA E1-06 FMAX E1-04</p>	0.0 to 255.0 *1	200.0 *1		Q	Q	- 5 - 12
	Max Voltage								
E1-06	Base frequency		<p>Output voltage (V)</p> <p>VMAX E1-05 VBASE E1-13 VC E1-08 VMIN E1-10</p> <p>FMIN E1-09 FB E1-07 FA E1-06 FMAX E1-04</p>	0.0 to 400.0	60.0		Q	Q	- 5 - 12
	Base Frequency								
E1-07	Mid. output frequency		<p>Output voltage (V)</p> <p>VMAX E1-05 VBASE E1-13 VC E1-08 VMIN E1-10</p> <p>FMIN E1-09 FB E1-07 FA E1-06 FMAX E1-04</p>	0.0 to 400.0	3.0		A		- 5
	Mid Frequency A								
E1-08	Mid. output frequency voltage		<p>Output voltage (V)</p> <p>VMAX E1-05 VBASE E1-13 VC E1-08 VMIN E1-10</p> <p>FMIN E1-09 FB E1-07 FA E1-06 FMAX E1-04</p>	0.0 to 255.0 *1	11.0 *1		A		- 5
	Mid Voltage A								
E1-09	Min. output frequency		<p>Output voltage (V)</p> <p>VMAX E1-05 VBASE E1-13 VC E1-08 VMIN E1-10</p> <p>FMIN E1-09 FB E1-07 FA E1-06 FMAX E1-04</p>	0.0 to 400.0	0.5 *2		Q	A	- 25 - 5 - 12
	Min Frequency								
E1-10	Min. output frequency voltage		<p>Output voltage (V)</p> <p>VMAX E1-05 VBASE E1-13 VC E1-08 VMIN E1-10</p> <p>FMIN E1-09 FB E1-07 FA E1-06 FMAX E1-04</p>	0.0 to 255.0 *1	2.0 *1		A		- 5
	Min Voltage								
E1-11	Mid. output frequency 2		<p>Output voltage (V)</p> <p>VMAX E1-05 VBASE E1-13 VC E1-08 VMIN E1-10</p> <p>FMIN E1-09 FB E1-07 FA E1-06 FMAX E1-04</p>	0.0 to 400.0	0.0 *3		A	A	--
	Mid Frequency B								
E1-12	Mid. output frequency voltage 2		<p>Output voltage (V)</p> <p>VMAX E1-05 VBASE E1-13 VC E1-08 VMIN E1-10</p> <p>FMIN E1-09 FB E1-07 FA E1-06 FMAX E1-04</p>	0.0 to 255.0 *1	0.0 *3		A	A	--
	Mid Voltage B								
E1-13	Base voltage		<p>Output voltage (V)</p> <p>VMAX E1-05 VBASE E1-13 VC E1-08 VMIN E1-10</p> <p>FMIN E1-09 FB E1-07 FA E1-06 FMAX E1-04</p>	0.0 to 255.0 *1	0.0 *4		Q	Q	- 5 - 12
	Base Voltage								

* 1. These are values for a 200 V class Inverter. Values for the 400 V class Inverter are double.

* 2. The factory setting will change when the control method is changed. (The open loop vector control factory setting is given.)

* 3. E1-11 and E1-12 are disregarded when set to 0.0.

* 4. E1-13 is set to the same value as E1-05 by autotuning.

■ Motor Setup: E2

Constant Number	Name		Description	Setting Range	Factory Setting	Change during Operation	Control Methods		Page
	Display						Open Loop Vector	Flux Vector	
E2-01	Motor rated current		Sets the motor rated current in 1 A units. These set values will become the reference values for motor protection, torque limits. These values will automatically be set if they were set during autotuning.	0.32 to 6.40 *2	1.90 *1		Q	Q	- 6 - 13
	Motor Rated FLA								

Constant Number	Name	Description	Setting Range	Factory Setting	Change during Operation	Control Methods		Page
	Display					Open Loop Vector	Flux Vector	
E2-02	Motor rated slip	Sets the motor rated slip in Hz units. These set values will become the reference values for slip compensation.	0.00 to 20.00	2.90 *1		Q	Q	- 6 - 13
	Motor Rated Slip	These values will be automatically set during autotuning.						
E2-03	Motor no-load current	Sets the motor no-load current in 1 A units.	0.00 to 1500.0	1.20 *1		Q	Q	- 7 - 13
	No-Load Current	These values will be automatically set during autotuning.						
E2-04	Number of motor poles	Sets the number of motor poles.	2 to 48	4			Q	- 14
	Number of Poles	These values will automatically be set during autotuning.						
E2-05	Motor line-to-line resistance	Sets the motor phase-to-phase resistance in Ω units.	0.000 to 65.000	9.842 *1		A	A	- 7 - 14
	Term Resistance	These values will be automatically set during autotuning.						
E2-06	Motor leak inductance	Sets the voltage drop due to motor leakage inductance as a percentage of the motor rated voltage.	0.0 to 30.0	18.2		A	A	- 7 - 14
	Leak Inductance	These values will be automatically set during autotuning.						
E2-07	Motor iron-core saturation coefficient 1	Sets the motor iron-core saturation coefficient at 50% of magnetic flux.	0.00 to 0.50	0.50		A	A	- 7 - 15
	Saturation Comp 1	These values will be automatically set during autotuning.						
E2-08	Motor iron-core saturation coefficient 2	Sets the motor iron-core saturation coefficient at 75% of magnetic flux.	0.00 to 0.75	0.75		A	A	- 7 - 15
	Saturation Comp 2	These values will be automatically set during autotuning.						
E2-09	Motor mechanical loss	Sets motor mechanical loss as a percentage of motor rated output (W). Usually setting is not necessary. Adjust in the following circumstances: • When torque loss is large due to motor bearing. • When the torque loss in the pump or fan is large.	0.0 to 10.0	0.0			A	- 15
	Mechanical Loss	The set mechanical loss will compensate for torque.						

* 1. The factory setting depends upon the Inverter capacity. The values for a 200 V class Inverter of 0.4 kW are given. See page - 35.

* 2. The setting range is 10% to 200% of the Inverter's rated output current. The value for a 200 V class Inverter of 0.4 kW is given.

■ Motor 2 Control Method: E3

Constant Number	Name	Description	Setting Range	Factory Setting	Change during Operation	Control Methods		Page
	Display					Open Loop Vector	Flux Vector	
E3-01	Motor 2 control method selection	2: Open loop vector 3: Flux vector control	2 3	2		A		--
	Control Method							

■ Motor 2 V/f Pattern: E4

Constant Number	Name Display	Description	Setting Range	Factory Setting	Change during Operation	Control Methods		Page
						Open Loop Vector	Flux Vector	
E4-01	Motor 2 max. output frequency V/F2 Max Freq	<p>To set V/f characteristics in a straight line, set the same values for E4-04 and E4-06. In this case, the setting for E4-05 will be disregarded. Always ensure that the four frequencies are set in the following manner: E4-01 (FMAX) E4-03 (FA) E4-04 (FB) E4-06 (FMIN)</p>	40.0 to 400.0	60.0		A		--
E4-02	Motor 2 max. voltage V/F2 Max Voltage		0.0 to 255.0*	200*		A		--
E4-03	Motor 2 max. voltage frequency V/F2 Base Freq		0.0 to 400.0	60.0		A		--
E4-04	Motor 2 mid. output frequency 1 V/F2 Mid Freq		0.0 to 400.0	3.0		A		--
E4-05	Motor 2 mid. output frequency voltage 1 V/F2 Mid Voltage		0.0 to 255.0*	11.0*		A		--
E4-06	Motor 2 min. output frequency V/F2 Min Freq		0.0 to 400.0	0.5		A		--
E4-07	Motor 2 min. output frequency voltage V/F2 Min Voltage		0.0 to 255.0*	2.0*		A		--

* When the control method is changed, the Inverter reverts to factory settings. (The open loop vector control factory settings are given.)

上正科技有限公司

購買、維修 此手冊零組件

電話： 037-466333

Email: service@repairtw.com

Line id: @zzzz

www.repairtw.com

■ Motor 2 Setup: E5

Constant Number	Name	Description	Setting Range	Factory Setting	Change during Operation	Control Methods		Page
	Display					Open Loop Vector	Flux Vector	
E5-01	Motor 2 rated current	Sets the motor rated current in 1 A units. These set values will become the reference values for motor protection, torque limits.	0.32 to 6.40 ^{*2}	1.90 ^{*1}		A		- 6
	Motor 2 rated FLA	These values will automatically be set if they were set during autotuning.						
E5-02	Motor 2 rated slip	Sets the motor rated slip in Hz units. These set values will become the reference values for slip compensation.	0.00 to 20.00	2.90 ^{*1}		A		- 6
	Motor 2 Slip Freq	These values will be automatically set during autotuning.						
E5-03	Motor 2 no-load current	Sets the motor no-load current in 1 A units. These values will be automatically set during autotuning.	0.00 to 1500.0	1.20 ^{*1}		A		- 7
	Motor 2 No-load 1							
E5-04	Motor 2 number of poles	Sets the number of motor poles. These values will automatically be set during autotuning.	2 to 48	4				
	Motor 2 # Poles							
E5-05	Motor 2 line-to-line resistance	Sets the motor phase-to-phase resistance in Ω units. These values will be automatically set during autotuning.	0.000 to 65.000	9.842 ^{*1}		A		- 7
	Motor 2 term Ohms							
E5-06	Motor 2 leak inductance	Sets the voltage drop due to motor leakage inductance as a percentage of the motor rated voltage. These values will be automatically set during autotuning.	0.0 to 30.0	18.2 ^{*1}		A		- 7
	Motor 2 Leak							

* 1. The factory setting depends upon the Inverter capacity. The values for a 200 V class Inverter of 0.4 kW are given. See page - 35.

* 2. The setting range is 10% to 200% of the Inverter's rated output current. The value for a 200V class Inverter of 0.4kW is given.

購買、維修 此手冊零組件

電話： 037-466333

Email: service@repairtw.com

Line id: @zzzz

www.repairtw.com

8.2.5 Options Constants: F

■ PG Option Setup: F1

Constant Number	Name		Description	Setting Range	Factory Setting	Change during Operation	Control Methods		Page
	Display						Open Loop Vector	Flux Vector	
F1-01	PG constant		Sets the number of PG (pulse generator or encoder) pulses.	0 to 60000	600			Q	- 22
	PG Pulse/Rev		Sets the number of pulses per motor revolution.						
F1-02	Operation selection at PG open circuit		Sets the PG disconnection stopping method. 0: Ramp to stop (Deceleration stop using deceleration time 1, C1-02.)	0 to 3	1			B	- 23
	PG Fdbk Loss Sel		1: Coast to stop 2: Fast stop (Emergency stop using the fast-stop time, C1-09.) 3: Continue operation (PGO is displayed, and continues operation.)						
F1-03	Operation selection at overspeed		Sets the stopping method when an overspeed (OS) fault occurs. 0: Ramp to stop (Deceleration stop using deceleration time 1, C1-02.)	0 to 3	1			B	- 24
	PG Overspeed Sel		1: Coast to stop 2: Fast stop (Emergency stop using the fast-stop time, C1-09.) 3: Continue operation (OS is displayed, and continues operation.)						
F1-04	Operation selection at deviation		Sets the stopping method when a speed deviation (DEV) fault occurs. 0: Ramp to stop (Deceleration stop using deceleration time 1, C1-02.)	0 to 3	3			B	- 24
	PG Deviation Sel		1: Coast to stop 2: Fast stop (Emergency stop using the fast-stop time, C1-09.) 3: Continue operation (DEV is displayed and continues operation.)						
F1-05	PG rotation		0: Phase A leads with forward run command. (Phase B leads with reverse run command.)	0 1	0			B	- 22
	PG Rotation Sel		1: Phase B leads with forward run command. (Phase A leads with reverse run command.)						
F1-06	PG division rate (PG pulse monitor)		Sets the division ratio for the PG speed control card pulse output. Division ratio = $(1+n)/m$ ($n=0,1$ $m=1$ to 32)	1 to 132	1			B	- 23
	PG Output Ratio		F1-06 = $\frac{n}{m}$ This constant is only effective when a PG-B2 is used. The possible division ratio settings are: $1/32 \leq F1-06 \leq 1$						
F1-08	Overspeed detection level		Sets the overspeed detection method.	0 to 120	115			A	- 24
	PG Overspd level		Frequencies above that set for F1-08 (set as a percentage of the maximum output frequency), which continue to exceed this frequency for the detection time (F1-09), are detected as overspeed faults.						
F1-09	Overspeed detection delay time			0.0 to 2.0	0.0 *			A	- 24
	PG Overspd Time								

* The setting range will change when the control method is changed. (The values for Open loop vector control is given.)

Constant Number	Name	Description	Setting Range	Factory Setting	Change during Operation	Control Methods		Page
	Display					Open Loop Vector	Flux Vector	
F1-10	Excessive speed deviation detection level	Sets the speed deviation detection method. Any speed deviation above the F1-10 set level (set as a percentage of the maximum output frequency), which continues for the deviation detection time (F1-11) is detected as a speed deviation.	0 to 50	10			A	- 24
	PG Deviate Level							
F1-11	Excessive speed deviation detection delay time	Speed deviation is the difference between actual motor speed and the reference command speed.	0.0 to 10.0	0.5			A	- 24
	PG Deviate Time							
F1-14	PG open-circuit detection time	Used to set the PG disconnection detection time. PGO will be detected if the detection time continues beyond the set time.	0.0 to 10.0	2.0			A	- 23
	PGO Time							

■ Other Options Setup: F2 through F9

F2: Analog Reference Card

F3: Digital Reference Card

F4: Analog Monitor Card

F5: DO-02 Digital Output Card

F6: DO-08 Digital Output Card

F7: Pulse Monitor Card

F8: SI-F/G

F9: DOS/SI-B

Constant Number	Name	Description	Setting Range	Factory Setting	Change during Operation	Control Methods		Page
	Display					Open Loop Vector	Flux Vector	
F2-01	Bi-polar or uni-polar input selection	Sets the functions for channel 1 to 3 which are effective when the AI-14B Analog Reference Card is used. 0: 3-channel individual (Channel 1: terminal 13, Channel 2: terminal 14, Channel 3: terminal 16) 1: 3-channel addition (Addition values are the frequency reference) When set to 0, select 1 for b1-01. In this case the multi-function input "Option/Inverter selection" cannot be used.	0 1	0		B	B	- 27
	AI-14 Input Sel							
F3-01	Digital input option	Sets the Digital Reference Card input method. 0: BCD 1% unit 1: BCD 0.1% unit 2: BCD 0.01% unit 3: BCD 1 Hz unit 4: BCD 0.1 Hz unit 5: BCD 0.01 Hz unit 6: BCD special setting (5-digit input) 7: Binary input 6 is only effective when the DI-16H2 is used.	0 to 7	0		B	B	- 28
	DI Input							
F4-01	Channel 1 monitor selection	Effective when the Analog Monitor Card is used. Monitor selection: Set the number of the monitor item to be output. (U1-)	1 to 33	2		B	B	- 28
	AO Ch1 Select							
F4-02	Channel 1 gain	Gain: Set the multiple of 10 V for outputting monitor items. 4, 10, 11, 12, 13, 14, 25, 28 cannot be set. 29 to 31 are not used. When the AO-12 is used outputs of ± 10 V are possible. In this case, set H4-07 (select multi-function analog output signal level) to 1. When the AO-08 is used, only outputs of 0 to +10 V are possible.	0.00 to 2.50	1.00		B	B	- 28
	AO Ch1 Gain							
F4-03	Channel 2 monitor selection	4, 10, 11, 12, 13, 14, 25, 28 cannot be set. 29 to 31 are not used. When the AO-12 is used outputs of ± 10 V are possible. In this case, set H4-07 (select multi-function analog output signal level) to 1. When the AO-08 is used, only outputs of 0 to +10 V are possible.	1 to 33	3		B	B	- 28
	AO Ch2 Select							
F4-04	Channel 2 gain	4, 10, 11, 12, 13, 14, 25, 28 cannot be set. 29 to 31 are not used. When the AO-12 is used outputs of ± 10 V are possible. In this case, set H4-07 (select multi-function analog output signal level) to 1. When the AO-08 is used, only outputs of 0 to +10 V are possible.	0.00 to 2.50	0.50		B	B	- 28
	AO Ch2 Gain							

Constant Number	Name	Description	Setting Range	Factory Setting	Change during Operation	Control Methods		Page
	Display					Open Loop Vector	Flux Vector	
F4-05	Channel 1 output monitor bias	Sets the channel 1 item bias to 100%/10 V when the analog monitor card is used.	-10.0 to 10.0	0.0		B	B	- 28
	AO Ch1 Bias							
F4-06	Channel 2 output monitor bias	Set the channel 2 item bias to 100%/10 V when the analog monitor card is used.	-10.0 to 10.0	0.0		B	B	- 28
	AO Ch2 Bias							
F5-01	Channel 1 output selection	Effective when a Digital Output Card is used. Set the number of the multi-function output to be output.	0.0 to 37	0		B	B	- 29
	DO-02 Ch1 Select							
F5-02	Channel 2 output selection	Effective when a Digital Output Card is used. Set the number of the multi-function output to be output.	0.0 to 37	1		B	B	- 29
	DO-02 Ch2 Select							
F6-01	Output mode selection	Effective when a DO-08 Digital Output Card is used. Set the output mode. 0: 8-channel individual outputs 1: Binary code output	0 1	0		B	B	- 29
	DO-08 Selection							
F7-01	Frequency multiple selection	Effective when the Pulse Monitor Card is used. Sets the number of output pulses. 0: 1F, 1: 6F, 2: 10F, 3: 12F, 4: 36F F= the output frequency displayed in Hz. Example: When 0 (1F) is set, and the output frequency is 60 Hz, 60 pulses per second are output. (50% duty)	0 to 4	1		B	B	- 30
	PO-36F Selection							
F8-01	Optical option (SIF/G)	0: Deceleration to stop 1: Coast to stop 2: Emergency stop 3: Continue operation	0 to 3	1		B	B	--
	E-15 Det Sel							
F9-01	External fault input level from Optical option	0: NO contact 1: NC contact	0, 1	0		B	B	--
	E-15 Selection							
F9-02	External fault from Optical option	0: Always detect 1: Detect during operation	0, 1	0		B	B	--
	EF0 Detection							
F9-03	Action for external fault from Optical option	0: Deceleration to stop 1: Coast to stop 2: Emergency stop 3: Continue operation	0 to 3	1		B	B	--
	EF0 Fault Act							
F9-04	Optical option trace sampling time	Line id: @z	0 to 6000	0		B	B	--
	Trace Sample Time							

8.2.6 Terminal Constants: H

■ Multi-function Inputs: H1

Constant Number	Name	Display	Setting Range	Factory Setting	Change during Operation	Control Methods		Page
						Open Loop Vector	Flux Vector	
H1-01	Multi-function input 1 (terminal 3)	Terminal 3 Sel	0 to 77	24		B	B	- 32
H1-02	Multi-function input 2 (terminal 4)	Terminal 4 Sel	0 to 77	14		B	B	- 32
H1-03	Multi-function input 3 (terminal 5)	Terminal 5 Sel	0 to 77	3 (0) *		B	B	- 32

Constant Number	Name	Display	Setting Range	Factory Setting	Change during Operation	Control Methods		Page
						Open Loop Vector	Flux Vector	
H1-04	Multi-function input 4 (terminal 6)	Terminal 6 Sel	0 to 77	4 (3) *		B	B	- 32
H1-05	Multi-function input 5 (terminal 7)	Terminal 7 Sel	0 to 77	6 (4) *		B	B	- 32
H1-06	Multi-function input 6 (terminal 8)	Terminal 8 Sel	0 to 77	8 (6) *		B	B	- 32

* The values in parentheses indicate initial values when initialized in 3-wire sequence.

Multi-function Input Functions

Setting value	Function	Control Methods		Page
		Open loop Vector	Flux vector	
0	3-wire sequence (Forward/Reverse run command)			- 13
1	Local/Remote selection (ON: Operator, OFF: Constant setting)			- 32
2	Option/Inverter selection (ON: Option card)			- 32
3	Multi-step speed reference 1 When H3-05 is set to "0," this function is combined with "Master/auxiliary speed switch."			- 13
4	Multi-step speed reference 2			- 13
5	Multi-step speed reference 3			- 13
6	Jog frequency reference (higher priority than multi-step speed reference)			- 13
7	Accel/Decel time 1			- 16
8	External baseblock NO (NO contact: Baseblock at ON)			- 32
9	External baseblock NC (NC contact: Baseblock at OFF)			- 32
A	Accel/Decel ramp hold (ON: Accel/decel stopped, frequency on hold)			- 33
B	OH2 alarm signal input (ON: OH2 will be displayed)			- 33
C	Multi-function analog input selection (ON: Enable)			- 33
E	Speed control integral reset (ON: Integral control disabled)			- 33
F	Not used. (Do not input this setting.)			
10	Up command (Always set with the down command)			- 34
11	Down command (Always set with the up command)			- 34
12	FJOG command (ON: Forward run at jog frequency d1-09)			- 16
13	RJOG command (ON: Reverse run at jog frequency d1-09)			- 16
14	Fault reset (Reset when turned ON)			- 35
15	Emergency stop (ON: Deceleration to stop in emergency stop time C1-09)			- 16
16	Motor switch command (Motor 2 selection)			- 35
1A	Accel/Decel time 2			- 16
1B	Constants write enable (ON: All constants can be written in; OFF: All constants other than frequency monitor are write protected.)			- 36
1C	Trim control increase (ON: d4-02 frequencies are added to analog frequency references.)			- 36
1D	Trim control decrease (ON: d4-02 frequencies are subtracted from analog frequency references.)			- 36
1E	Analog frequency reference sample/hold			- 37
1F	Frequency reference terminal 13/14 selection (ON: selects terminal 14)			- 16
20 to 2F	External fault (Desired settings possible) Input mode: NO contact/NC contact, Detection mode: Normal/during operation Stopping method: Deceleration to stop, coast to stop, emergency stop or continue operation.			- 37
60	DC injection braking command (ON: Performs DC injection braking)			- 40
61	External speed search command 1: Maximum output frequency (ON: speed search)			- 40
62	External speed search command 2: Set frequency (ON: speed search)			- 40
64	External speed search command 3			
65	KEB (deceleration at momentary power loss) command (NO contact)			
66	KEB (deceleration at momentary power loss) command (NO contact)			
77	Speed control (ASR) proportional gain switch (ON: C5-03)			- 41
80	Winding change			- 67

Setting value	Function	Control Methods		Page
		Open loop Vector	Flux vector	
81	MC answerback (N.C.)			- 68
82	MC answerback (N.O.)			- 68

■ Multi-function Outputs: H2

Constant Number	Name	Display	Setting Range	Factory Setting	Change during Operation	Control Methods		Page
						Open Loop Vector	Flux Vector	
H2-01	Multi-function input (terminal 9-10)	Terminal 9 Sel	0 to 37	0		B	B	- 42
H2-02	Multi-function input (terminal 25-27)	Terminal 25 Sel	0 to 37	1		B	B	- 42
H2-03	Multi-function input (terminal 26-27)	Terminal 26 Sel	0 to 37	2		B	B	- 42

Multi-function Output Functions

Setting value	Function	Control Methods		Page
		Open loop Vector	Flux vector	
0	During run ON: run command is ON or voltage is being output)			- 43
1	Zero-speed			- 43
2	Frequency agree 1: (Detection width L4-02)			- 54
3	Desired frequency agree 1 (ON: Output frequency = \pm L4-01, detection width in L4-02)			- 54
4	Frequency (Four) detection 1 (ON: $+L4-01 \geq$ output frequency $\geq -L4-01$, detection width in L4-02)			- 54
5	Frequency (Four) detection 2 (ON: Output frequency $\geq +L4-01$ or output frequency $\leq -L4-01$, detection width in L4-02)			- 54
6	Inverter operation ready READY: After initialization, no faults			
7	During DC bus undervoltage (UV) detection			
8	During baseblock (ON: during baseblock)			
9	Frequency reference selection (ON: Frequency reference from Operator)			
A	Run command selection (ON: Run command from Operator)			
B	Overtorque detection 1 NO (NO Contact: Overtorque detection at ON)			- 56
C	Loss of frequency reference (Effective when operation selection is "1" for L4-05 frequency reference missing)			- 54
D	Braking resistor fault (ON: Resistor overheat or braking transistor fault)			
E	Fault (ON: Faults other than CPF00, CPF01 have occurred.)			NO TAG
F	Not used. (Do not set.)			
10	Minor fault (ON: Alarm displayed)			NO TAG
11	Fault reset command active			
12	Not used. (Do not set.)			
13	Frequency agree 2 (Detection width: L4-04)			- 54
14	Desired frequency agree 2 (ON: Output frequency = L4-03, detection width in L4-04)			- 54
15	Frequency detection 3 (ON: Output frequency $\leq -L4-03$, detection width in L4-04)			- 54
16	Frequency detection 4 (ON: Output frequency $\geq -L4-03$, detection width in L4-04)			- 54
17	Overtorque detection 1 NC (NC Contact: Torque detection at OFF)			- 56
18	Overtorque detection 2 NO (NO Contact: Torque detection at ON)			- 56
19	Overtorque detection 2 NC (NC Contact: Torque detection at OFF)			- 56
1A	During reverse run (ON: During reverse run)			
1B	During baseblock 2 (OFF: During baseblock)			
1C	Motor selection (ON: During motor 1 selection)			
1D	Regenerating (ON: Regenerating)			
1E	Restart enabled (ON: Restart enabled)			- 56
1F	Motor overload (OL1) pre-alarm (ON: 90% or more of the detection level)			- 43
20	Inverter overheat (OH) pre-alarm (ON: Temperature exceeds L8-02 setting)			- 43
30	During torque limit (current limit) (ON: During torque limit)			
31	During speed limit. (ON: During speed limit)			- 43
37	During run 2 (ON: Frequency output, OFF: Base block, DC injection braking, initial excitation, operation stop.)			- 43

Setting value	Function	Control Methods		Page
		Open loop Vector	Flux vector	
40	Zero speed 2 (ON: Zero speed, not included during Y/ winding change)			
41	Motor selection (ON:During moter 2 selection)			- 41

■ Analog Inputs: H3

Constant Number	Name	Description	Setting Range	Factory Setting	Change during Operation	Control Methods		Page
	Display					Open Loop Vector	Flux Vector	
H3-01	Signal level selection (terminal 13)	0: 0 to 10V [11-bit + polarity (positive/negative) input]	0 1	0		B	B	- 4
	Term 13 Signal	1: 0 to 10V						
H3-02	Gain (terminal 13)	Sets the frequency when 10 V is input, as a percentage of the maximum output frequency.	0.0 to 1000.0	100.0		B	B	- 6
	Terminal 13 Gain							
H3-03	Bias (terminal 13)	Sets the frequency when 0 V is input, as a percentage of the maximum frequency.	-100.0 to +100.0	0.0		B	B	- 6
	Terminal 13 Bias							
H3-04	Signal level selection (terminal 16)	0: 0 to 10V [11-bit + polarity (positive/negative) input]	0 1	0		B	B	- 6
	Term 16 Signal	1: 0 to 10V						
H3-05	Multi-function analog input (terminal 16)	Select from the functions listed in the following table. Refer to page - 44.	0 to 1F	0		B	B	- 44
	Terminal 16 Sel							
H3-06	Gain (terminal 16)	Sets the input gain (level) when terminal 16 is 10 V.	0.0 to 1000.0	100.0		B	B	- 6
	Terminal 16 Gain	Set according to the 100% value on page - 44.						
H3-07	Bias (terminal 16)	Sets the input gain (level) when terminal 16 is 0 V.	-100.0 to +100.0	0.0		B	B	- 6
	Terminal 16 Bias	Set according to the 100% value on page - 44						
H3-08	Signal level selection (terminal 14)	0: 0 to +10 V (Always cut jumper wire J1)	0 to 2	2		A	A	6 - 4
	Term 14 Sel	1: 0 to ±10 V (Always cut jumper wire J1) 2: 4 to 20 mA (10-bit input)						
H3-09	Multi-function analog input (terminal 14)	Set as for H3-05. Cannot be set to 0. The 1F function will become "frequency reference."	1 to 1F	1F		A	A	- 4 - 44
	Terminal 14 Sel							
H3-10	Gain (terminal 14)	Sets the input gain (level) when terminal 14 is 10 V (20 mA).	0.0 to 1000.0	100.0		A	A	- 6
	Terminal 14 Gain	Set according to the 100% value on page - 44. If H3-09 = 1F the setting in H3-02 is used.						
H3-11	Bias (terminal 14)	Sets the input gain (level) when terminal 14 is 0 V (4 mA).	-100.0 to +100.0	0.0		A	A	- 6
	Terminal 14 Bias	Set according to the 100% value on page - 44. If H3-09 = 1F the setting in H3-03 is used.						
H3-12	Analog input filter time constant	Sets terminals 13, 14, 16 to primary delay filter time constant, in seconds units.	0.00 to 2.00	0.00		A	A	- 7
	Filter Avg Time	Effective for noise control etc.						

H3-05 and H3-09 Settings

Setting	Function	Contents	Control Methods	
			Open Loop Vector	Flux Vector
0	H3-05: Auxiliary frequency reference	Maximum output frequency		
	H3-09: "0" cannot be set			
1	Frequency gain	Frequency reference (voltage) command value		
2	Frequency bias	Maximum output frequency (added to H3-03)		
5	Accel/decel change (reduction coefficient)	Set acceleration and deceleration times (C1-01 to C1-08)		
6	DC injection braking current	Inverter rated output current		
7	Overtorque detection level	Motor rated torque		
9	Frequency reference lower limit level	Maximum output frequency		
A	Jump frequency	Maximum output frequency		
10	Forward torque limit	Motor's rated torque		
11	Reverse torque limit	Motor's rated torque		
12	Regeneration torque limit	Motor's rated torque		
13	Torque reference/torque limit at speed control	Motor's rated torque		
14	Torque compensation bias	Motor's rated torque		
15	Forward/reverse side torque limit	Motor's rated torque		
1F	H3-05: Not used (terminal 14; frequency reference)			
	H3-09: Frequency reference	Maximum output frequency		

上正科技有限公司

購買、維修 此手冊零組件

電話： 037-466333

Email: service@repairtw.com

Line id: @zzzz

www.repairtw.com

■ Analog Outputs: H4

Constant Number	Name	Description	Setting Range	Factory Setting	Change during Operation	Control Methods		Page
	Display					Open Loop Vector	Flux Vector	
H4-01	Monitor selection (terminal 21)	Sets the number of the monitor item to be output (U1-) from terminal 21.	1 to 33	2		B	B	- 46
	Terminal 21 Sel	4, 10, 11, 12, 13, 14, 25, 28 cannot be set and 29 to 31 are not used.						
H4-02	Gain (terminal 21)	Sets the multi-function analog output 1 voltage level gain.	0.00 to 2.50	1.00		B	B	- 46
	Terminal 21 Gain	Sets whether the monitor item output will be output in multiples of 10 V.						
H4-03	Bias (terminal 21)	Sets the multi-function analog output 1 voltage level bias.	-10.0 to +10.0	0.0		B	B	- 46
	Terminal 21 Bias	Sets output characteristic up/down parallel movement as a percentage of 10 V.						
H4-04	Monitor selection (terminal 23)	Sets the number of the monitor item to be output (U1-) from terminal 23.	1 to 33	3		B	B	- 46
	Terminal 23 Sel	4, 10, 11, 12, 13, 14, 25, 28 cannot be set and 29 to 31 are not used.						
H4-05	Gain (terminal 23)	Sets the multi-function analog output 2 voltage level gain.	0.00 to 2.50	0.50		B	B	- 46
	Terminal 23 Gain	Sets whether the monitor item output will be output in multiples of 10 V.						
H4-06	Bias (terminal 23)	Sets the multi-function analog output 2 voltage level bias.	-10.0 to +10.0	0.0		B	B	- 46
	Terminal 23 Bias	Sets output characteristic up/down parallel movement as a percentage of 10 V.						
H4-07	Analog output signal level selection	Sets the signal output level for multi-function outputs 1 and 2 (terminals 21, 23.) 0: 0 to +10 V output 1: 0 to +10 V output	0 to 1	0		B	B	- 46
	AO Level Select	The optional Analog Monitor Card may also be used with this setting.						

■ MEMOBUS Communications: H5

Constant Number	Name	Description	Setting Range	Factory Setting	Change during Operation	Control Methods		Page
	Display					Open Loop Vector	Flux Vector	
H5-01	Station address Serial Com Adr	Set the Inverter's node address.	0 to 20	1		A	A	--
H5-02	Communication speed selection	Set the baud rate for 6CN MEMOBUS communications. 0: 1200 bps 1: 2400 bps 2: 4800 bps 3: 9600 bps	0 to 3	1		A	A	--
	Serial Com Sel							
H5-03	Communication parity selection	Set the parity for 6CN MEMOBUS communications. 0: No parity 1: Even parity 2: Odd parity	0 to 2	1		A	A	--
	Serial Com Sel							
H5-04	Stopping method after communication error	Set the stopping method for communications errors. 0: Deceleration stop 1: Coast to stop 2: Emergency stop 3: Continue operation	0 to 3	1		A	A	--
	Serial Fault Sel							

Constant Number	Name	Description	Setting Range	Factory Setting	Change during Operation	Control Methods		Page
	Display					Open Loop Vector	Flux Vector	
H5-05	Communication error detection selection	Set whether or not a communications timeout is to be detected as a communications error.	0 1	1		A	A	--
	Serial Flt Dct	0: Do not detect. 1: Detect						

8.2.7 Protection Constants: L

■ Motor Overload: L1

Constant Number	Name	Description	Setting Range	Factory Setting	Change during Operation	Control Methods		Page
	Display					Open Loop Vector	Flux Vector	
L1-01	Motor protection selection	Sets whether the motor overload function is enabled or disabled at electric thermal overload relay. 0: Disabled 1: Enabled In some applications when the Inverter power supply is turned off, the thermal value is reset, so even if this constant is set to 1, (Enabled), protection may not be effective.	0 1	1		B	B	-48
	MOL Fault Select	When several motors are connected to one Inverter, set to 0 (Disabled) and ensure that each motor is installed with a protection device.						
L1-02	Motor protection time constant	Sets the electric thermal detection time in seconds units. Usually setting is not necessary. The factory setting is 150% overload for one minute. When the motor's overload resistance is known, set at the overload resistance when the motor is hot started.	0.1 to 5.0	1.0		B	B	-48
	MOL Time Const							

■ Power Loss Ridethrough: L2

Constant Number	Name	Description	Setting Range	Factory Setting	Change during Operation	Control Methods		Page
	Display					Open Loop Vector	Flux Vector	
L2-01	Momentary power loss detection	0: Disabled (Undervoltage fault detection). 1: Enabled (Restarted when the power returns within the time for L2-02. When L2-02 is exceeded, undervoltage fault detection.)	0 to 2	0		B	B	-49
	PwrL Selection	2: Enabled while CPU is operating. (Restarts when power returns during control operations. Does not detect undervoltage fault.)						
L2-02	Momentary power loss ridethru time	Sets the recovery time, when momentary power loss selection (L2-01) is set to 1, in units of one second.	0.0 to 2.0	0.7 *1		B	B	-49
	PwrL Ridethru t							
L2-03	Min. baseblock time	Sets the Inverter's minimum baseblock time in units of one second, when the Inverter is restarted after power loss ridethrough.	0.0 to 5.0	0.5 *1		B	B	-50
	PwrL Baseblock t	Sets the time for the motor's residual voltage to dissipate. When an overcurrent occurs when starting a speed search or DC injection braking, increase the set values.						

Constant Number	Name	Description	Setting Range	Factory Setting	Change during Operation	Control Methods		Page
	Display					Open Loop Vector	Flux Vector	
L2-04	Voltage recovery time	Sets the time required to return to normal voltage at the completion of a speed search, in units of one second.	0.0 to 5.0	0.3		A	A	- 50
	PwrL V/F Ramp t	Set the time required for a 200 V class Inverter to recover from 0 V to 200 VAC. (For the 400 V class Inverter, the time from 0 V to 400 VAC.)						
L2-05	Undervoltage detection level	Sets the main circuit under voltage (UV) detection level (main circuit DC voltage) in V units. Usually setting is not necessary. Insert an AC reactor to lower the main circuit undervoltage detection level.	150 to 210 *2	190 *2		A	A	- 50
	PUV Det Level							
L2-06	KEB deceleration rate	Restores the operating conditions for momentary power loss by applying a frequency deceleration to create inertia energy when a power loss occurs, and thus avoid the power loss.	0.0 to 100.0	0.0		A	A	- 50
	KEB Frequency							

* 1. The factory setting depends upon the Inverter capacity. The values for a 200 V class Inverter of 0.4 kW are given. See page - 35.

* 2. These are values for a 200 V class Inverter. Value for a 400 V class Inverter is double.

■ Stall Prevention: L3

Constant Number	Name	Description	Setting Range	Factory Setting	Change during Operation	Control Methods		Page
	Display					Open Loop Vector	Flux Vector	
L3-01	Stall prevention selection during accel	0: Disabled (Acceleration as set. With a heavy load, the motor may stall.) 1: Enabled (Acceleration stopped when L3-02 level is exceeded. Acceleration starts again when the current is returned.)	0 to 2	1		B		- 51
	StallP Accel Sel	2: Intelligent acceleration mode (Using the L3-02 level as a basis, acceleration is automatically adjusted. Set acceleration time is disregarded.)						
L3-02	Stall prevention level during accel	Effective when L3-01 is set to 1 or 2. Set as a percentage of Inverter rated current.	0 to 200	150		B		- 51
	StallP Accel Lvl	Usually setting is not necessary. The factory setting reduces the set values when the motor stalls.						
L3-03	Stall prevention limit during accel	Sets the lower limit for stall prevention during acceleration, as a percentage of the Inverter rated current, when operation is in the frequency range above the maximum voltage frequency (E1-06.)	0 to 100	50		A		- 52
	StallP CHP Lvl	Usually setting is not necessary.						

Constant Number	Name	Description	Setting Range	Factory Setting	Change during Operation	Control Methods		Page
	Display					Open Loop Vector	Flux Vector	
L3-04	Stall prevention selection during decel	0: Disabled (Deceleration as set. If deceleration time is too short, a main circuit overvoltage may result.) 1: Enabled (Deceleration is stopped when the main circuit voltage exceeds the overvoltage level. Deceleration restarts when voltage is returned.) 2: Intelligent deceleration mode (Deceleration rate is automatically adjusted so that in Inverter can decelerate in the shortest possible time. Set deceleration time is disregarded.)	0 to 3	1		B	B	- 53
	StallP Decel Sel	3: Enabled (with braking resistor) When a braking option (Braking Resistor, Braking Resistor Unit, Braking Unit) is used, always set to 0 (Disabled.)						

■ Reference Detection: L4

Constant Number	Name	Description	Setting Range	Factory Setting	Change during Operation	Control Methods		Page
	Display					Open Loop Vector	Flux Vector	
L4-01	Speed agree detection level	Effective when "Desired frequency (ref/setting) agree 1," "Frequency detection 1," "Frequency detection 2," are set for multi-function output.	0.0 to 400.0	0.0		B	B	- 54
	Spd Agree Level	Frequencies to be detected are set in Hz units.						
L4-02	Speed agree detection width	Effective when "Frequency (ref/out) agree 1," "Desired frequency (ref/setting) agree 1," "Frequency detection 1," "Frequency detection 2" are set for multi-function output.	0.0 to 20.0	2.0		B	B	- 54
	Spd Agree Width	Sets the frequency detection width in Hz units.						
L4-03	Speed Agree detection level (+/-)	Effective when "Desired frequency (ref/setting) agree 2," "Frequency detection 3," "Frequency detection 4," are set for multi-function output.	-400.0 to 400.0	0.0		A	A	- 54
	Spd Agree Lvl + -	Frequency detection width is set in Hz units.						
L4-04	Speed agree detection width (+/-)	Effective when "Frequency (ref/out) agree 2," "Desired frequency (ref/setting) agree 1," "Frequency detection 3," "Frequency detection 4" are set for multi-function output.	0.0 to 20.0	2.0		A	A	- 54
	Spd Agree Wdth + -	Frequency detection width is set in Hz units.						
L4-05	Operation when frequency reference is missing	0: Stop (Operation follows the frequency reference.) 1: Operation at 80% speed continues. (At 80% of speed before the frequency reference was lost)	0 1	0		A	A	- 54
	Ref Loss Sel	Frequency reference is lost: Frequency reference dropped over 90% in 400 ms.						

■ Fault Restart: L5

Constant Number	Name	Description	Setting Range	Factory Setting	Change during Operation	Control Methods		Page
	Display					Open Loop Vector	Flux Vector	
L5-01	Number of auto restart attempts	Sets the number of auto restart attempts. Automatically restarts after a fault and conducts a speed search from the run frequency.	0 to 10	0		B	B	- 56
	Num of Restarts							
L5-02	Auto restart operation selection	Sets whether a fault contact output is activated during fault restart. 0: Not output (Fault contact is not activated.) 1: Output (Fault contact is activated.)	0 1	0		B	B	- 56
	Restart Sel							

■ Torque Detection: L6

Constant Number	Name	Description	Setting Range	Factory Setting	Change during Operation	Control Methods		Page
	Display					Open Loop Vector	Flux Vector	
L6-01	Torque detection selection 1	0: Overtorque detection disabled. 1: Detection during speed agree only/Operation continues after detection (Minor fault) 2: Detection during run/Operation continues after detection (Minor fault) 3: Detection during speed agree only/Inverter output is shut off after detection (Fault) 4: Detection during run/Inverter output is shut off after detection (Fault)	0 to 4	0		B	B	- 56
	Torq Det 1 Sel							
L6-02	Torque detection level 1	Vector control: Motor rated torque is set as 100%.	0 to 300	150		B	B	- 56
	Torq Det 1 Lvl							
L6-03	Torque detection time 1	Sets the torque detection time in 1-second units.	0.0 to 10.0	0.1		B	B	- 56
	Torq Det 1 Time							
L6-04	Torque detection selection 2	Setting procedure is the same as for "Torque detection selection 1" (L6-01 to L6-03). The following outputs are possible:	0 to 4	0		A	A	- 56
	Torq Det 2 Sel							
L6-05	Torque detection level 2	Torque detection selection 1: Multi-function output "Torque detection selection 1", NO/NC	0 to 300	150		A	A	- 56
	Torq Det 2 Lvl							
L6-06	Torque detection time 2	Torque detection selection 2: Multi-function output "Torque detection selection 2", NO/NC	0.0 to 10.0	0.1		A	A	- 56
	Torq Det 2 Time							

■ Torque Limit: L7

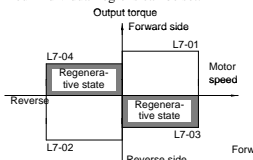
Constant Number	Name		Description	Setting Range	Factory Setting	Change during Operation	Control Modes		Page	
	Display						Open Loop Vector	Flux Vector		
L7-01	Forward torque limit		Sets the torque limit value as a percentage of the motor rated torque. Four individual regions can be set. 	0 to 300	200		B	B	- 3 - 11	
	Torq Limit Fwd									
L7-02	Reverse torque limit				0 to 300	200		B	B	- 3 - 11
	Torq Limit Rev									
L7-03	Forward regenerative torque limit			0 to 300	200		B	B	- 3 - 11	
	Torq Lmt Fwd Rgn									
L7-04	Reverse regenerative torque limit			0 to 300	200		B	B	- 3 - 11	
	Torq Lmt Rev Rgn									

■ Hardware Protection: L8

Constant Number	Name		Description	Setting Range	Factory Setting	Change during Operation	Control Methods		Page
	Display						Open Loop Vector	Flux Vector	
L8-01	Protect selection for internal DB resistor (Type ERF)		0: Disabled (no overheating protection) 1: Enabled (overheating protection) 2: 3% ED 3: 10% ED	0 to 3	0		B	B	- 57
	DB Resistor Prot								
L8-02	Overheat pre-alarm level		Sets the detection temperature for the Inverter overheat detection pre-alarm in °C. The pre-alarm detects when the cooling fan temperature reaches the set value.	50 to 110	95		A	A	- 58
	OH Pre-Alarm Lvl								
L8-03	Operation selection after overheat pre-alarm		Sets the operation for when the inverter overheat pre-alarm goes ON. 0: Ramp to stop in deceleration time C1-02. 1: Coast to stop 2: Fast stop in fast-stop time C1-09. 3: Continue operation (Monitor display only). A fault will be given in setting 0 to 2 and a minor fault will be given in setting 3.	0 to 3	3		A	A	- 58
	OH Pre-Alarm Sel								
L8-05	Input open-phase protection selection		0: Disabled 1: Enabled (Detects if input current open-phase, power supply voltage imbalance or main circuit electrostatic capacitor deterioration occurs.)	0 1	0		A	A	- 58
	Ph Loss In Sel								
L8-07	Output open-phase protection selection		0: Disabled 1: Enabled (Output open-phase detected at less than 5% of Inverter rated current.) Output open-phase may be detected inadvertently when applied motor capacity is small for Inverter capacity. In this case, set to 0 (Disabled.)	0 1	0		A	A	- 58
	Ph Loss Out Sel								
L8-10	Ground protection selection		0: Disabled 1: Enabled	0 1	1		A	A	--
	Gnd Det Sel								

Constant Number	Name	Description	Setting Range	Factory Setting	Change during Operation	Control Methods		Page
	Display					Open Loop Vector	Flux Vector	
L8-17	Carrier frequency reduction selection	0: No carrier frequency reduction 1: With carrier frequency reduction 2: For factory adjustments 3: For factory adjustments If the metallic noise (carrier noise) generated from the motor at low speeds (less than 6 Hz) becomes a problem, set L8-17 to 0 and L8-19 to 1. However, do not set L8-17 or L8-19 to 0 when using open-loop vector control.	0 to 3	1		A		- 59
	L-Spd IGBT Prtct							
L8-19	OL2 characteristics selection at low speeds	0: OL2 characteristics at low speeds disabled. 1: OL2 characteristics at low speeds enabled. If using OL2 to trip at low speeds (less than 6 Hz) even though the load is light, set L8-17 to 1 and L8-19 to 0. However, do not set L8-17 or L8-19 to 0 when using open-loop vector control. Do not set L8-19 to when using a 400 V class (185 to 300 kW) Inverter.	0 1	0		A	A	- 59
	OL2 Chara @ L-Spd							

上正科技有限公司

購買、維修 此手冊零組件

電話： 037-466333

Email: service@repairtw.com

Line id: @zzzz

www.repairtw.com

8.2.8 Operator Constants: o

■ Monitor Select: o1

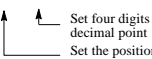
Constant Number	Name	Description	Setting Range	Factory Setting	Change during Operation	Control Methods		Page
	Display					Open Loop Vector	Flux Vector	
o1-01	Monitor selection	Set the number of the monitor item to be displayed in the earliest 4 monitor items. (U1-)	4 to 33	6		B	B	- 60
	Monitor Select	The output monitor voltage (factory setting) can be changed.						
o1-02	Monitor selection after power up	Sets the monitor item to be displayed when the power is turned on. 1: Frequency reference 2: Output frequency 3: Output current 4: The monitor item set for o1-01	1 to 4	1		B	B	- 60
	Power-On Monitor							
o1-03	Frequency units of reference setting and monitor	Sets the units that will be set and displayed for the frequency reference and frequency monitor. 0: 0.01 Hz units 1: 0.01% units (Maximum output frequency is 100%) 2 to 39:r/min units (Sets the motor poles.) 40 to 39999: User desired display Set the desired values for setting and display for the max. output frequency.	0 to 39999	0		B	B	- 7 - 60
	Display Scaling	 <p>Set four digits without the decimal point Set the position of the decimal point in the first digit. Example: When the max. output frequency value is 200.0, set 12000</p>						
o1-04	Frequency units of constant setting	Set the V/f pattern setting units. (E1-04, 06, 09 set units) 0: Hz units 1: r/min units	0 to 0	0		B	B	- 13
	Display Units	Effective only in the flux vector control mode.						
o1-05	Constant No. display selection	Set the Operator constant number display method. 0: Normal display (e.g., A1-00) 1: Display MEMOBUS communications register address	0 to 0	0		A	A	- 60
	Address Display							

Email: service@repairtw.com

Line id: @zzz

www.repairtw.com

■ Multi-function Selections: o2

Constant Number	Name	Description	Setting Range	Factory Setting	Change during Operation	Control Methods		Page
	Display					Open Loop Vector	Flux Vector	
o2-01	LOCAL/REMOTE key enable/disable	Sets the Digital Operator Local/Remote Key 0: Disabled 1: Enabled (Switches between the Digital Operator and the constant settings.)	0 1	1		B	B	- 60
	Local/remote key							
o2-02	STOP key during control circuit terminal operation	Sets the Stop Key in the run mode. 0: Disabled (When the run command is issued from and external terminal, the Stop Key is disabled.) 1: Enabled (Effective even during run.)	0 1	1		B	B	- 61
	Oper STOP Key							
o2-03	User constant initial value	Clears or stores user initial values. 0: Stores/not set 1: Begins storing (Records the set constants as user initial values.) 2: All clear (Clears all recorded user initial values) When the set constants are recorded as user initial values, 1110 will be displayed in the Initialize mode (A1-03.)	0 to 2	0		B	B	- 61
	User Defaults							
o2-04	kVA selection Inverter Model #	Do not set.	0 to FF*	0*		B	B	- 61
o2-05	Frequency reference setting method selection	When the frequency reference is set on the Digital Operator frequency reference monitor, sets whether the Enter Key is necessary. 0: Enter Key needed 1: Enter Key not needed When set to 1, the Inverter accepts the frequency reference without Enter Key operation.	0 1	0		A	A	- 61
	Operator M.O.P.							
o2-06	Operation selection when digital operator is disconnected	Sets the operation when the Digital Operator is disconnected. 0: Disabled (Operation continues even if the Digital Operator is disconnected.) 1: Enabled (OPR is detected at Digital Operator disconnection. Inverter output is cut off, and fault contact is operated.)	0 1	0		A	A	- 63
	Oper Detection							
o2-07	Cumulative operation time setting	Sets the cumulative operation time in hour units. Operation time is calculated from the set values.	0 to 65535	0		A	A	- 63
	Elapsed Time Set							
o2-08	Cumulative operation time selection	0: Cumulative time when the Inverter power is on. (All time while the Inverter power is on is accumulated.) 1: Cumulative Inverter run time. (Only Inverter output time is accumulated.)	0 1	0		A	A	- 63
	Elapsed Time Run							
o2-09	Initialize mode selection Init Mode Sel	Do not set.	0 to 2	0		A	A	

* The factory setting depends upon the Inverter capacity. The values for a 200 V class Inverter of 0.4 kW are given.

8.2.9 Winding Change Constants: P

■ Winding Change: P1

Constant Number	Name	Description	Setting Range	Factory Setting	Change during Operation	Control Methods		Page
	Display					Open Loop Vector	Flux Vector	
P1-01	Winding Change frequency	Winding change frequency from Y-winding and -winding	0.0 to 400.0	0.0		A	A	- 67 - 69
	Changeover freq							
P1-02	Winding change hysteresis	Winding change hysteresis	0.0 to 20.0	5.0		A	A	- 68 - 69
	Frequency Width							
P1-03	Answerback error detection	Time setting of MC answerback error detection	0.20 to 1.00	0.20		A	A	- 68 - 70
	Ansback Det Time							
P1-04	Motor constant selection	Constant setting for Y-winding Selecting motor 1/motor 2 0: Motor 1 constants (E1, E2) are used for Y-winding, and motor 2 constants (E3, E4, E5) are used for -winding 1: Motor 2 constants (E3, E4, E5) are used for Y-winding, and motor 2 constants (E1, E2) are used for -winding	0 1	1		A	A	- 66 - 68 - 70
	Wye Winding sel							
P1-05	Programming mode valid/invalid during run	MENU and ESC key valid/invalid during run 0: Disabled 1: Enabled	0 1	1		A	A	- 70
	Program Mode @ RUN							

■ PG Orientation: P3

Constant Number	Name	Description	Setting Range	Factory Setting	Change during Operation	Control Methods		Page
	Display					Open Loop Vector	Flux Vector	
P3-01	Main Axis Zero Point Position Origin	Sets the mechanical zero point of the load axis as a number of pulses.	0 to 4095	0 pulses	No	B	B	--
P3-02	Position Control Gain (H)	Sets the position control proportional gain when a high-speed gear is selected (MGR and LGR are OFF) or when high-speed winding is selected (CHW is OFF).	1 to 99	10	No	B	B	--
	Position Gain H							
P3-05	Positioning Completion Detection Width	Sets the detection width for outputting the completion signal as a number of pulses when the load axis approaches the command stop position.	1 to 99	3 pulses	No	B	B	--
	ORE Set Pulse							
P3-06	Positioning Completion Cancel Width	Sets the positioning completion cancel width as a number of pulses when the load axis is displaced after the completion signal is output.	0 to 200	10 pulses	No	B	B	--
	ORE Reset Pulse							
P3-07	Orientation Speed	Sets the speed applied until changing to the servo loop during orientation.	60 to 600	400 r/min	No	B	B	--
	ORT Speed							
P3-08	Gear Ratio (H)	Sets the gear ratio determined by mechanical specifications. Gear Ratio = Load axis speed / Motor speed	0.0500 to 1.5000	1.0000	No	B	B	--
	Gear Ratio H							
P3-11	Gear Direction	Sets the rotation direction of the motor axis and load axis. 0: Same 1: Reverse	0 or 1	0	No	B	B	--
	Gear Direction							
P3-12	Dither Level	Sets the dither signal level in units of 0.6 rpm.	0 to 50	0	No	B	B	--
	Dither Level							

8.2.10 Factory Settings that Change with the Control Method (A1-02)

Constant No.	Name	Setting Range	Unit	Factory Setting	
	Display			Open Loop Vector A1-02=2	Flux Vector A1-02=3
b3-01	Speed search selection at start SpfSrch at Start	0 1	1	0	1
C3-01	Slip compensation gain Slip Comp gain	0.0 to 2.5	0.1	1.0	1.0
E1-04 E4-01	Max. output frequency Max Frequency	0.0 to 400.0	0.1 Hz	60.0	60.0
E1-05 E4-02	Max. voltage Max Voltage	0.0 to 255.0	0.1 V	200.0	200.0
E1-06 E4-03	Max. voltage frequency Max Voltage Frequency	0.0 to 400.0	0.1 Hz	60.0	60.0
E1-07 E4-04	Mid. output frequency Mid Frequency A	0.0 to 400.0	0.1 Hz	3.0	0.0
E1-08 E4-05	Mid. output frequency voltage Mid voltage A	0.0 to 255.0 (0.0 to 510.0)	0.1 V	11.0 (22.0)	0.0
E1-09 E4-06	Min. output frequency Min Frequency	0.0 to 400.0	0.1 Hz	0.5	0.0

Note Values in parentheses are for 400 V class Inverters.

上正科技有限公司

購買、維修 此手冊零組件

電話： 037-466333

Email: service@repairtw.com

Line id: @zzzz

www.repairtw.com

8.2.11 Factory Settings that Change with the Inverter Capacity (o2-04)

■ 200 V Class Inverters

Constant No.	Name	Unit	Factory Setting							
			0.4	0.75	1.5	2.2	3.7	5.5	7.5	11
	Inverter Capacity	kW	0.4	0.75	1.5	2.2	3.7	5.5	7.5	11
o2-04	kVA selection	1	0	1	2	3	4	5	6	7
C6-01	Carrier frequency upper limit	kHz	15.0	15.0	15.0	15.0	15.0	15.0	15.0	15.0
	Carrier frequency upper limit range	kHz	15.0	15.0	15.0	15.0	15.0	15.0	15.0	15.0
E2-01 (E5-01)	Motor rated current	A	1.90	3.30	6.20	8.50	14.00	19.60	26.60	39.7
E2-02 (E5-02)	Motor rated slip	Hz	2.90	2.50	2.60	2.90	2.73	1.50	1.30	1.70
E2-03 (E5-03)	Motor no-load current	A	1.20	1.80	2.80	3.00	4.50	5.10	8.00	11.2
E2-05 (E5-05)	Motor line-to-line resistance		9.842	5.156	1.997	1.601	0.771	0.399	0.288	0.230
E2-06 (E5-06)	Motor leak inductance	%	18.2	13.8	18.5	18.4	19.6	18.2	15.5	19.5
L2-02	Momentary power loss ride thru time	sec	0.7	1.0	1.0	1.0	2.0	2.0	2.0	2.0
L2-03	Min. baseblock time	sec	0.5	0.5	0.5	0.5	0.5	0.7	0.7	0.7
L2-04	Voltage recovery time	sec	0.3	0.3	0.3	0.3	0.3	0.3	0.3	0.3

Constant No.	Name	Unit	Factory Setting							
			15	18.5	22	30	37	45	55	75
	Inverter Capacity	kW	15	18.5	22	30	37	45	55	75
o2-04	kVA selection	1	8	9	A	B	C	D	E	F
C6-01	Carrier frequency upper limit	kHz	15.0	15.0	10.0	10.0	10.0	10.0	10.0	10.0
	Carrier frequency upper limit range	kHz	15.0	15.0	10.0	10.0	10.0	10.0	10.0	10.0
E2-01 (E5-01)	Motor rated current	A	53.0	65.8	77.2	105.0	131.0	160.0	190.0	260.0
E2-02 (E5-02)	Motor rated slip	Hz	1.60	1.67	1.70	1.80	1.33	1.60	1.43	1.39
E2-03 (E5-03)	Motor no-load current	A	15.2	15.7	18.5	21.9	38.2	44.0	45.6	72.0
E2-05 (E5-05)	Motor line-to-line resistance		0.138	0.101	0.079	0.064	0.039	0.030	0.022	0.023
E2-06 (E5-06)	Motor leak inductance	%	17.2	20.1	19.5	20.8	18.8	20.2	20.5	20.0
L2-02	Momentary power loss ride thru time	sec	2.0	2.0	2.0	2.0	2.0	2.0	2.0	2.0
L2-03	Min. baseblock time	sec	0.7	1.0	1.0	1.0	1.0	1.0	1.0	1.0
L2-04	Voltage recovery time	sec	0.3	0.3	0.3	0.6	0.6	0.6	0.6	0.6

■ 400 V Class Inverters

Constant No.	Name	Unit	Factory Setting								
			0.4	0.75	1.5	2.2	3.7	4.0	5.5	7.5	11
	Inverter Capacity	kW	0.4	0.75	1.5	2.2	3.7	4.0	5.5	7.5	11
o2-04	kVA selection	1	20	21	22	23	24	25	26	27	28
C6-01	Carrier frequency upper limit *	kHz	15.0	15.0	15.0	15.0	15.0	15.0	15.0	12.5	12.5
	Carrier frequency upper limit range	kHz	15.0	15.0	15.0	15.0	15.0	15.0	15.0	15.0	15.0
E2-01 (E5-01)	Motor rated current	A	1.00	1.60	3.10	4.20	7.00	7.00	9.80	13.30	19.9
E2-02 (E5-02)	Motor rated slip	Hz	2.90	2.60	2.50	3.00	2.70	2.70	1.50	1.30	1.70
E2-03 (E5-03)	Motor no-load current	A	0.60	0.80	1.40	1.50	2.30	2.30	2.60	4.00	5.6
E2-05 (E5-05)	Motor line-to-line resistance		38.198	22.459	10.100	6.495	3.333	3.333	1.595	1.152	0.922
E2-06 (E5-06)	Motor leak inductance	%	18.2	14.3	18.3	18.7	19.3	19.3	18.2	15.5	19.6
L2-02	Momentary power loss ridethru time	sec	1.0	1.0	1.0	1.0	2.0	2.0	2.0	2.0	2.0
L2-03	Min. baseblock time	sec	0.5	0.5	0.5	0.5	0.5	0.7	0.7	0.7	0.7
L2-04	Voltage recovery time	sec	0.3	0.3	0.3	0.3	0.3	0.3	0.3	0.3	0.3

Constant No.	Name	Unit	Factory Setting								
			15	18.5	22	30	37	45	55	75	
	Inverter Capacity	kW	15	18.5	22	30	37	45	55	75	
o2-04	kVA selection	1	29	2A	2B	2C	2D	2E	2F	30	
C6-01	Carrier frequency upper limit	kHz	12.5	12.5	10.0	10.0	10.0	7.0	6.0	6.0	
	Carrier frequency upper limit range	kHz	15.0	15.0	15.0	15.0	10.0	10.0	10.0	10.0	
E2-01 (E5-01)	Motor rated current	A	26.5	32.9	38.6	52.3	65.6	79.7	95.0	130.0	
E2-02 (E5-02)	Motor rated slip	Hz	1.60	1.67	1.70	1.80	1.33	1.60	1.46	1.39	
E2-03 (E5-03)	Motor no-load current	A	7.6	7.8	9.2	10.9	19.1	22.0	24.0	36.0	
E2-05 (E5-05)	Motor line-to-line resistance		0.550	0.403	0.316	0.269	0.155	0.122	0.088	0.092	
E2-06 (E5-06)	Motor leak inductance	%	17.2	20.1	23.5	20.7	18.8	19.9	20.0	20.0	
L2-02	Momentary power loss ridethru time	sec	2.0	2.0	2.0	2.0	2.0	2.0	2.0	2.0	
L2-03	Min. baseblock time	sec	0.7	1.0	1.0	1.0	1.0	1.0	1.0	1.0	
L2-04	Voltage recovery time	sec	0.3	0.6	0.6	0.6	0.6	0.6	0.6	0.6	

* When frequency upper limit is set higher than the factory setting with the inverter of 7.5kW or more, inverter rated current should be reduced. Contact your YASKAWA representative for details.

9

Troubleshooting

This chapter describes the fault displays and countermeasure for the VS-626MCS and motor problems and countermeasures.

9.1	Protective and Diagnostic Functions	9 - 2
9.1.1	Fault Detection	9 - 2
9.1.2	Minor Fault Detection	9 - 6
9.1.3	Operation Errors	9 - 8
9.2	Troubleshooting	9 - 9
9.2.1	If Constant Constants Cannot Be Set	9 - 9
9.2.2	If the Motor Does Not Operate	9 - 9
9.2.3	If the Direction of the Motor Rotation is Reversed	9 - 11
9.2.4	If the Motor Does Not Put Out Torque or If Acceleration is Slow	9 - 11
9.2.5	If the Motor Does Not Operate According to Reference	9 - 11
9.2.6	If the Slip Compensation Function Has Low Speed Precision	9 - 11
9.2.7	If There is Low Speed Control Accuracy at High-speed Rotation in Open-loop Vector Control Mode	9 - 11
9.2.8	If Motor Deceleration is Slow	9 - 12
9.2.9	If the Motor Overheats	9 - 12
9.2.10	If There is Noise When the Inverter is Started or From an AM Radio	9 - 12
9.2.11	If the Ground Fault Interrupter Operates When the Inverter is Run	9 - 13
9.2.12	If There is Mechanical Oscillation	9 - 13
9.2.13	If the Motor Rotates Even When Inverter Output is Stopped	9 - 13
9.2.14	If 0 V is Detected When the Fan is Started, or Fan Stalls	9 - 13
9.2.15	If Output Frequency Does Not Rise to Frequency Reference	9 - 14
9.2.16	Winding change error has occurred	9 - 14

9.1 Protective and Diagnostic Functions

9.1.1 Fault Detection

When the Inverter detects a fault, the fault code is displayed on the Digital Operator, the fault contact output operates, and the Inverter output is shut OFF causing the motor to coast to a stop. (The stopping method can be selected for some faults, and the selected stopping method will be used with these faults.)

- When a fault has occurred, refer to the following table to identify and correct the cause of the fault.
- Use one of the following methods to reset the fault after restarting the Inverter:
 - Turn ON the fault reset signal.
(A multi-function input (H1-01 to H1-06) must be set to 14 (Fault Reset).)
 - Press the RESET Key on the Digital Operator.
 - Turn the main circuit power supply off and then on again.

Table 9.1 Fault Displays and Processing

Fault Display	Meaning	Probable Causes	Corrective Actions
OC Overcurrent	Overcurrent The Inverter output current exceeded the overcurrent detection level. (200% of rated current)	<ul style="list-style-type: none"> • A short-circuit or ground fault occurred at the Inverter output. (A short or ground fault can be caused by motor burn damage, worn insulation, or a damaged cable.) • The load is too large or the acceleration/deceleration time is too short. • A special-purpose motor or motor with a capacity too large for the Inverter is being used. • A magnetic switch was switched at the Inverter output. 	Reset the fault after correcting its cause.
GF Ground Fault	Ground Fault The ground fault current at the Inverter output exceeded approximately 50% of the Inverter rated output current.	A ground fault occurred at the Inverter output. (A ground fault can be caused by motor burn damage, worn insulation, or a damaged cable.)	Reset the fault after correcting its cause.
PUF DC Bus Fuse Open	Fuse Blown The fuse in the main circuit is blown.	The output transistor has failed because of a short-circuit or ground fault at the Inverter output. Check whether there is a short-circuit between the following terminals. A short-circuit will damage the output transistor. B1 (⊕3) ↔ U, V, W ⊖ ↔ U, V, W	Replace the Inverter after correcting the cause.
SC Short Circuit	Load Short-circuit The Inverter output or load was short-circuited.	A short-circuit or ground fault occurred at the Inverter output. (A short or ground fault can be caused by motor burn damage, worn insulation, or a damaged cable.)	Reset the fault after correcting its cause.
OV Overvoltage	Main Circuit Overvoltage The main circuit DC voltage exceeded the overvoltage detection level. 200 V class: Approx. 400 V 400 V class: Approx. 800 V	The deceleration time is too short and the regenerative energy from the motor is too large. The power supply voltage is too high.	Increase the deceleration time or connect a braking resistor (or Braking Resistor Unit). Decrease the voltage so it's within specifications.
UV1 DC Bus Undervolt	Main Circuit Undervoltage The main circuit DC voltage is below the undervoltage detection level (L2-05). 200 V class: Approx. 190 V 400 V class: Approx. 380 V	<ul style="list-style-type: none"> • An open-phase occurred with the input power supply. • A momentary power loss occurred. • The wiring terminals for the input power supply are loose. • The voltage fluctuations in the input power supply are too large. 	Reset the fault after correcting its cause.
UV2 CTL PS Undervolt	Control Power Fault The control power supply voltage dropped.	--	<ul style="list-style-type: none"> • Try turning the power supply off and on. • Replace the Inverter if the fault continues to occur.
UV3 MC Answerback	Inrush Prevention Circuit Fault A fault occurred in the inrush prevention circuit.	--	<ul style="list-style-type: none"> • Try turning the Inverter the power supply off and on. • Replace the Inverter if the fault continues to occur.

Fault Display	Meaning	Probable Causes	Corrective Actions
PF Input Pha Loss	Main Circuit Voltage Fault The main circuit DC voltage oscillates unusually (not when regenerating). This fault is detected when L8-05 is set to "Enabled."	<ul style="list-style-type: none"> An open-phase occurred in the input power supply. A momentary power loss occurred. The wiring terminals for the input power supply are loose. The voltage fluctuations in the input power supply are too large. The voltage balance between phases is bad. 	Reset the fault after correcting its cause.
LF Output Pha Loss	Output Open-phase An open-phase occurred at the Inverter output. This fault is detected when L8-07 is set to "Enabled."	<ul style="list-style-type: none"> There is a broken wire in the output cable. There is a broken wire in the motor-winding. The output terminals are loose. <p>The motor being used has a capacity less than 5% of the Inverter's maximum motor capacity.</p>	Reset the fault after correcting its cause. Check the motor and Inverter capacity.
OH OH1 Heatsink Over tmp	Cooling Fin Overheating The temperature of the Inverter's cooling fins exceeded the setting in L8-02 or 105°C.	<p>The ambient temperature is too high.</p> <p>There is a heat source nearby.</p> <p>The Inverter's cooling fan has stopped.</p>	<p>Install a cooling unit.</p> <p>Remove the heat source.</p>
	Inverter internal cooling fan stopped (18.5kW or more)	Inverter internal cooling fan has stopped (18.5kW or more).	Replace the cooling fan. (Contact your Yaskawa representative.)
RH Dyn Brk Resistor	Installed Braking Resistor Overheating The braking resistor is overheated and the protection function set with L8-01 has operated.	The deceleration time is too short and the regenerative energy from the motor is too large.	<ul style="list-style-type: none"> Reduce the load, increase the deceleration time, or reduce the motor speed. Change to a Braking Resistor Unit.
RR Dyn Brk Transistr	Internal Braking Transistor Fault The braking transistor is not operating properly.	--	<ul style="list-style-type: none"> Try turning the power supply off and on. Replace the Inverter if the fault continues to occur.
OL1 Motor Overloaded	Motor Overload The motor overload protection function has operated based on the internal electronic thermal value.	<p>The load is too heavy. The acceleration time, deceleration time, and cycle time are too short.</p> <p>The V/f characteristics voltage is too high.</p>	<p>Check the size of the load and the length of the acceleration, deceleration, and cycle times.</p> <p>Check the V/f characteristics.</p>
		The motor's rated current setting (E2-01) is incorrect.	Check the motor's rated current setting (E2-01).
OL2 Inv Overloaded	Inverter Overload The Inverter overload protection function has operated based on the internal electronic thermal value.	<p>The load is too heavy. The acceleration time, deceleration time and cycle time are too short.</p> <p>The V/f characteristics voltage is too high.</p>	<p>Check the size of the load and the length of the acceleration, deceleration, and cycle times.</p> <p>Check the V/f characteristics.</p>
		The Inverter capacity is too low.	Replace the Inverter with one that has a larger capacity.
OL3 Overtorque Det 1	Overtorque 1 There has been a current greater than the setting in L6-02 for longer than the setting in L6-03.	--	<ul style="list-style-type: none"> Make sure that the settings in L6-02 and L6-03 are appropriate. Check the mechanical system and correct the cause of the overtorque.
OL4 Overtorque det 2	Overtorque 2 There has been a current greater than the setting in L6-05 for longer than the setting in L6-06.	--	<ul style="list-style-type: none"> Make sure that the current setting in L6-05 and time setting in L6-06 are appropriate. Check the mechanical system and correct the cause of the overtorque.
OS Over speed	Overspeed The speed has been greater than the setting in F1-08 for longer than the setting in F1-09.	<p>Overshooting/Undershooting are occurring.</p> <p>The reference speed is too high.</p> <p>The settings in F1-08 and F1-09 aren't appropriate.</p>	<p>Adjust the gain again.</p> <p>Check the reference circuit and reference gain.</p> <p>Check the settings in F1-08 and F1-09.</p>
PGO PG open	PG Disconnection Detected The PG is disconnected. The inverter is outputting a frequency, but PG pulses aren't being input.	<p>There is a break in the PG wiring.</p> <p>The PG is wired incorrectly.</p> <p>Power isn't being supplied to the PG.</p>	<p>Fix the broken/disconnected wiring.</p> <p>Fix the wiring.</p> <p>Supply power to the PG properly.</p> <p>Check for open circuit when using brake (motor).</p>
		--	

Fault Display	Meaning	Probable Causes	Corrective Actions
DEV Speed Deviation	Excessive Speed Deviation The speed deviation has been greater than the setting in F1-10 for longer than the setting in F1-11.	The load is too heavy.	Reduce the load.
		The acceleration time and deceleration time are too short.	Lengthen the acceleration time and deceleration time.
		The load is locked.	Check the mechanical system.
		The settings in F1-10 and F1-11 aren't appropriate.	Check the settings in F1-10 and F1-11.
		--	Check for open circuit when using brake (motor).
CF Out of Control	Control Fault The torque limit was reached continuously for 3 seconds or longer during a deceleration stop during open-loop vector control.	--	Check the motor constants.
MCANS Winding Change	MC answerback error Answerback signal is not received within the time set by constant P1-03. Winding change was not performed properly.	H1 fault setting	Reset the constant setting.
		MC is not excited.	Excite the magnetic contactor.
		Wiring is faulty.	Fix the wiring.
OPR Oper Disconnect	Operator Connection Fault The Operator was disconnected during operation started by a run command from the Operator.	--	Check the Operator connection.
EFO Opt External Flt	External fault input from Transmission Option Card.	--	Check the Transmission Option Card and transmission signal.
EF3 External Fault 3	External fault (Input terminal 3)	An "external fault" was input from a multi-function input.	<ul style="list-style-type: none"> Reset external fault inputs to the multi-function inputs. Remove the cause of the external fault.
EF4	External fault (Input terminal 4)		
EF5	External fault (Input terminal 5)		
EF6	External fault (Input terminal 6)		
EF7	External fault (Input terminal 7)		
EF8	External fault (Input terminal 8)		
CPF00 COM-ERR (OP&INV)	Operator Communications Error 1 Communications with the Operator were not established within 5 seconds after the power was turned on.		
		The Inverter's control circuits are faulty.	Replace the Inverter.
CPF01 COM-ERR (OP&INV)	Operator Communications Error 2 After communications were established, there was a transmission error with the Digital Operator for more than 2 seconds.	The Digital Operator isn't connected properly.	Disconnect the Digital Operator and then connect it again.
		The Inverter's control circuits are faulty.	Replace the Inverter.
CPF02 BB Circuit Err	Baseblock circuit error	--	Try turning the power supply off and on again.
		The control circuit is damaged.	Replace the Inverter.
CPF03 EEPROM Error	EEPROM error	--	Try turning the power supply off and on again.
		The control circuit is damaged.	Replace the Inverter.
CPF04 Internal A/D Err	CPU internal A/D converter error	--	Try turning the power supply off and on again.
		The control circuit is damaged.	Replace the Inverter.
CPF05 External A/D Err	CPU external A/D converter error	--	Try turning the power supply off and on again.
		The control circuit is damaged.	Replace the Inverter.
CPF06 Option Error	Option Card connection error	The Option Card is not connected properly.	Turn off the power and insert the Card again.
		The Inverter or Option Card is faulty.	Replace the faulty component.
CPF20 Option A/D Error	Option Card A/D converter error	The Option Card is not connected properly.	Turn off the power and insert the Card again.
		The Option Card's A/D converter is faulty.	Replace the Option Card.

Fault Display	Meaning	Probable Causes	Corrective Actions
CPF21 Option CPU down	Transmission Option Card self diagnostic error	Option Card fault.	Replace the Option Card.
CPF22 Option Type Err	Transmission Option Card model code error		
CPF23 Option DPRAM Err	Transmission Option Card DPRAM error		

上正科技有限公司
 購買、維修 此手冊零組件
 電話： 037-466333
 Email: service@repairtw.com
 Line id: @zzzz
 www.repairtw.com

9.1.2 Minor Fault Detection

Minor faults are a type of Inverter protection function that do not operate the fault contact output and are automatically returned to their original status once the cause of the minor fault has been removed.

The Digital Operator display blinks and the minor fault is output from the multi-function outputs (H2-01 to H2-03).

Take appropriate countermeasures according to the table below.

Table 9.2 Minor Fault Displays and Processing

Minor fault display	Meaning	Probable causes	Corrective Actions
EF (blinking) External Fault	Forward/Reverse Run Commands Input Together Both the forward and reverse run commands have been ON for more than 0.5 s.	--	Check the sequence of the forward and reverse run commands. Since the rotational direction is unknown, the motor will be decelerated to a stop when this minor fault occurs.
UV (blinking) DC Bus Undervolt	Main Circuit Undervoltage The following conditions occurred when there was no Run signal. <ul style="list-style-type: none"> The main circuit DC voltage was below the undervoltage detection level (L2-05). The surge current limiting contactor opened. The control power supply voltage when below the CUV level. 	See causes for UV1 UV2 and UV3 faults.	See corrective actions for UV1 UV2 and UV3 faults.
OV (blinking) Overvoltage	Main Circuit Overvoltage The main circuit DC voltage exceeded the overvoltage detection level. 200 V class: Approx. 400 V 400 V class: Approx. 800 V	The power supply voltage is too high.	Decrease the voltage so it's within specifications.
OH (blinking) Heatsink Over tmp	Cooling Fin Overheating The temperature of the Inverter's cooling fins exceeded the setting in L8-02.	The ambient temperature is too high.	Install a cooling unit.
		There is a heat source nearby.	Remove the heat source.
		The Inverter cooling fan has stopped.	Replace the cooling fan. (Contact your Yaskawa representative.)
OH2 (blinking) Over Heat 2	Inverter Overheating Pre-alarm An OH2 alarm signal (Inverter overheating alarm signal) was input from a multi-function input.	--	Clear the multi-function input's overheating alarm input.
OL3 (blinking) Overtorque Det 1	Overtorque 1 There has been a current greater than the setting in L6-02 for longer than the setting in L6-03.	--	<ul style="list-style-type: none"> Make sure that the settings in L6-02 and L6-03 are appropriate. Check the mechanical system and correct the cause of the overtorque.
OL4 (blinking) Overtorque Det 2	Overtorque 2 There has been a current greater than the setting in L6-05 for longer than the setting in L6-06.	--	<ul style="list-style-type: none"> Make sure that the current setting in L6-05 and time setting in L6-06 are appropriate. Check the mechanical system and correct the cause of the overtorque.
OS (blinking) Over speed	Overspeed The speed has been greater than the setting in F1-08 for longer than the setting in F1-09.	Overshooting/undershooting are occurring.	Adjust the gain again.
		The reference speed is too high.	Check the reference circuit and reference gain.
		The settings in F1-08 and F1-09 aren't appropriate.	Check the settings in F1-08 and F1-09.
PGO (blinking) PG open	The PG is disconnected. The Inverter is outputting a frequency, but PG pulses aren't being input.	There is a break in the PG wiring.	Fix the broken/disconnected wiring.
		The PG is wired incorrectly.	Fix the wiring.
		Power isn't being supplied to the PG.	Supply power to the PG properly.
DEV (blinking) Speed Deviation	Excessive Speed Deviation The speed deviation has been greater than the setting in F1-10 for longer than the setting in F1-11.	The load is too large.	Reduce the load.
		The acceleration time and deceleration time are too short.	Lengthen the acceleration time and deceleration time.
		The load is locked.	Check the mechanical system.
		The settings in F1-10 and F1-11 aren't appropriate.	Check the settings in F1-10 and F1-11.

Minor fault display	Meaning	Probable causes	Corrective Actions
EF3 (blinking) External Fault 3	External fault (Input terminal 3)	An "external fault" was input from a multi-function input.	<ul style="list-style-type: none"> Reset external fault inputs to the multi-function inputs. Remove the cause of the external fault.
EF4 (blinking)	External fault (Input terminal 4)		
EF5 (blinking)	External fault (Input terminal 5)		
EF6 (blinking)	External fault (Input terminal 6)		
EF7 (blinking)	External fault (Input terminal 7)		
EF8 (blinking)	External fault (Input terminal 8)		
CE MEMOBUS Com Err	Communications Error Normal reception was not possible for 2 s after received control data.	--	Check the communications devices and signals.
BUS Option Com Err	Option Card Transmission Error A communications error occurred in a mode where the run command or a frequency reference is set from an Transmission Option Card.	--	Check the Transmission Card and signals.
CALL Serial Com Call	SI-B Communications Error Control data was not normally received when power was turned ON.	--	Check the communications devices and signals.
E-15 SI-F/G Com Err	SI-F/G Communications Error Detected A communications error occurred in a mode where run or a frequency reference is set from an Transmission Option Card and E-15 is set to continue operation.	--	Check the communications signals.
EF0 Opt External Fit	DDS/SI-B External Error Detected An external error was received from an Option Card when EF0 was set to continue operation.	--	Remove the cause of the external error.

上正科技有限公司

購買、維修 此手冊零組件

電話： 037-466333

Email: service@repairtw.com

Line id: @zzzz

www.repairtw.com

9.1.3 Operation Errors

After the constants have been set, an operation error will occur if there is an invalid setting or a contradiction between two constant settings.

It won't be possible to start the Inverter until the constants have been set correctly. (The minor fault output and fault contact output will not operate, either.)

When an operation error has occurred, refer to the following table to identify and correct the cause of the errors.

Table 9.3 Operation Error Displays and Incorrect Settings

Display	Meaning	Incorrect settings
OPE01 kVA Selection	Incorrect Inverter capacity setting	The Inverter capacity setting doesn't match the Unit. (Contact your Yaskawa representative.)
OPE02 Limit	Constant setting range error	The constant setting is outside of the valid setting range.
OPE03 Terminal	Multi-function input selection error	One of the following errors has been made in the multi-function input (H1-01 to H1-06) settings: <ul style="list-style-type: none"> The same setting has been selected for two or more multi-function inputs. An up or down command was selected independently. (They must be used together.) The up/down commands (10 and 11) and Accel/Decel Ramp Hold (A) were selected at the same time. Speed Search 1 (61, maximum output frequency) and Speed Search 2 (62, set frequency) were selected at the same time. External Baseblock NO (8) and External Baseblock NC (9) were selected at the same time. The Terminal 13/14 Switch (1F) was selected, but the terminal 14 function selector (H3-09) wasn't set to frequency reference (1F).
OPE05 Sequence Select	Option Card selection error	The Option Card was selected as the frequency reference source by setting b1-01 to 3, but an Option Card isn't connected.
OPE06 PG Opt Missing	Control method selection error	Flux vector control was selected by setting A1-02 to 3, but a PG Speed Control Card isn't connected.
OPE07 Analog Selection	Multi-function analog input selection error	<ul style="list-style-type: none"> The same setting (other than 1F) has been selected for H3-05 and H3-09. An A1-14B Analog Reference Card is being used and F2-01 is set to 0, but a multi-function input (H1-01 to H1-06) has been set to Option/Inverter Selection (2).
OPE08 Elevator Table	Constant selection error	A setting has been made that is not required in the current control method. Ex.: A function used only with flux vector control was selected for open-loop vector control.
OPE10 V/f Ptrn Setting	V/f data setting error	Constants E1-04, E1-06, E1-07, and E1-09 do not satisfy the following conditions: <ul style="list-style-type: none"> E1-04 (FMAX) - E1-06 (FA) - E1-07 (FB) - E1-09 (FMIN).
OPE11 CarrFrg/On-Delay	Constant setting error	One of the following constant setting errors exists. <ul style="list-style-type: none"> The carrier frequency upper limit (C6-01) > 5 KHz and the carrier frequency lower limit (C6-02) < 5 KHz. The carrier frequency gain (C6-03) > 6 and (C6-01) > (C6-02). Upper/lower limit error in C6-01 to 03 or C8-15.
OPE12	Winding change sequence error	One of the following errors exists: <ul style="list-style-type: none"> Multi-function digital input is set to 80 (winding change) and 16 (Motor 2 selection) at the same time. Multi-function digital input is set to 81 and 82 at the same time. Multi-function digital input is set to 81, or b1-02 is not set to 5 when P1-01 is not 0.
ERR EEPROM R/W Err	EEPROM write error	A verification error occurred when writing EEPROM. <ul style="list-style-type: none"> Try turning the power supply off and on again. Try setting the constants again.

9

9.2 Troubleshooting

Due to constant setting errors, faulty wiring, and so on, the Inverter and motor may not operate as expected when the system is started up. If that should occur, use this section as a reference and apply the appropriate measures.

If the contents of the fault are displayed, refer to *9.1 Protective and Diagnostic Functions*.

9.2.1 If Constant Constants Cannot Be Set

■ The display does not change when the Increment and Decrement Keys are pressed.

1. Passwords do not match. (Only when a password is set.)

- If the constant A1-04 (Password 1) and A1-05 (Password 2) numbers are different, the constants for the initialize mode cannot be changed. Reset the password.
- If you cannot remember the password, display A1-05 (select password) by pressing the Reset/Select Key and the Menu Key simultaneously while in the A1-04 display. Then reset the password. (Input the reset password in constant A1-04.)

2. Constant write enable is input.

- This occurs when "constant write enable" (set value: 1B) is set for a multi-function input. If the constant write enable input is OFF, the constants cannot be changed. Turn it ON and then set the constants.

3. The Inverter is operating (drive mode).

- There are some constants that cannot be set during operation. Turn the Inverter off and then make the settings.

■ OPE01 through OPE11 is displayed.

- This is a constant setting error. The set value for the constant is wrong. Refer to *9.1.3 Operation Errors* and correct the setting.

■ CPF00 or CPF01 is displayed.

- This is a Digital Operator communications error. The connection between the Digital Operator and the Inverter may be faulty. Remove the Digital Operator and then re-install it.

9.2.2 If the Motor Does Not Operate

■ The motor does not operate when the Run Key on the Digital Operator is pressed.

IMPORTANT

If the Inverter is not in drive mode, it will remain in ready status and will not start. Press the Menu Key to display the operation mode, and enter the drive mode by pressing the Enter Key.

1. The operation method setting is wrong.

- If constant b1-02 (run source) is set to "1" (Control circuit terminal), the motor will not operate when the Run Key is pressed. Either press the Local/Remote Key* to switch to Digital Operator operation or set constant b1-02 to "0" (Digital Operator).

The Local/Remote Key is enabled (set value: 1) or disabled (set value: 2) by means of constant o2-01. It is enabled when the drive mode is entered.

2. The frequency reference is too low.

- If the frequency reference is set below the frequency set in E1-09 (minimum output frequency), the Inverter will not operate.
Raise the frequency reference to at least the minimum output frequency. (Related constant: b1-05)

3. There is a multi-function analog input setting error.

- If multi-function analog inputs H3-05 and H3-09 are set to "1" (frequency gain), and if no voltage (current) is input, then the frequency reference will be zero. Check to be sure that the set value and analog input value are correct.

4. Frequency reference 2 is specified with multi-step speed operation, and auxiliary frequency reference is not input.

- If multi-function analog input H3-05 is set to "0" (auxiliary frequency reference), and if multi-step speed reference is used, the auxiliary frequency reference will be treated as frequency reference 2. Check to be sure that the set value and analog input value (terminal 16) are correct.

5. A digital setting was made for frequency reference 2 for multi-step speed operation, but "1F" was not set for a multi-function analog input (H3-05).

- The auxiliary frequency reference is treated as frequency reference 2 when the multi-step speed references are used and "0" (auxiliary frequency reference) is set for the multi-function analog input (H3-05).
- Make sure that "1F" is set for the multi-function analog input (H3-05) and that the setting of frequency reference 2 is appropriate.

■ **The motor does not operate when an external operation signal is input.**

NOTE

If the Inverter is not in operation mode, it will remain in ready status and will not start. Press the Menu Key to display the drive mode, and enter the drive mode by pressing the Enter Key.

1. The operation method selection is wrong.

- If constant b1-02 (run source) is set to "0" (Digital Operator), the motor will not operate when an external operation signal is input. Set b1-02 to "1" (control circuit terminal) and try again.
- Similarly, the motor will also not operate if the Local/Remote Key has been pressed to switch to Digital Operator operation. In that case press the Local/Remote Key* again to return to the original setting.
The Local/Remote Key is enabled (set value: 1) or disabled (set value: 2) by means of constant o2-01. It is enabled when drive mode is entered.

2. A 3-wire sequence is in effect.

- The input method for a 3-wire sequence is different than when operating by forward/stop and reverse/stop (2-wire sequence). When 3-wire sequence is set, the motor will not operate even when an input terminal suitable for forward run/stop and reverse run/stop is turned ON.
- When using a 3-wire sequence, refer to the timing chart on page - 13 and input the proper signals.
- When using a 2-wire sequence, set multi-function inputs H1-01 through H1-06 to a value other than 0.

3. The frequency reference is too low.

- If the frequency reference is set below the frequency set in E1-09 (minimum output frequency), the Inverter will not operate.
Raise the frequency reference to at least the minimum output frequency. (Related constant: b1-05)

4. There is a multi-function analog input setting error.

- If multi-function analog inputs H3-05 and H3-09 are set to "1" (frequency gain), and if no voltage (current) is input, then the frequency reference will be zero. Check to be sure that the set value and analog input value are correct.

5. Frequency reference 2 is specified with multi-step speed operation and auxiliary frequency reference is not input.

- If multi-function analog input H3-05 is set to "0" (auxiliary frequency reference) and if multi-step speed reference is used, the auxiliary frequency reference will be treated as frequency reference 2. Check to be sure that the set value and analog input value (terminal 16) are correct.

6. A digital setting was made for frequency reference 2 for multi-step speed operation, but "1F" was not set for a multi-function analog input (H3-05).

- The auxiliary frequency reference is treated as frequency reference 2 when the multi-step speed references are used and "0" (auxiliary frequency reference) is set for the multi-function analog input (H3-05).
- Make sure that "1F" is set for the multi-function analog input (H3-05) and that the setting of frequency reference 2 is appropriate.

■ **The motor stops during acceleration or when a load is connected.**

- The load may be too heavy. The Inverter has a stall prevention function and an automatic torque boost function, but the motor responsiveness limit may be exceeded if acceleration is too rapid or if the load is too heavy. Lengthen the acceleration time or reduce the load. Also consider increasing the motor capacity.

9.2.3 If the Direction of the Motor Rotation is Reversed

- The motor output wiring is faulty. When the Inverter T1(U), T2(V), and T3(W) are properly connected to the motor T1(U), T2(V), and T3(W), the motor operates in a forward direction when a forward run command is executed. The forward direction depends on the manufacturer and the motor type, so be sure to check the specifications. Switching two wires among the T1(U), T2(V), and T3(W) will reverse the direction of rotation.

9.2.4 If the Motor Does Not Put Out Torque or If Acceleration is Slow

■ The torque limit has been reached.

- When a torque limit has been set in constants L7-01 to L7-04, no torque will be output beyond that limit. This can cause the torque to be insufficient, or the acceleration time to be too long. Check to be sure that the value set for the torque limit is suitable.
If the torque limit has been set by multi-function analog inputs H3-05 and H3-09 (set value: 10 to 13), check to be sure that the analog input value is suitable.

■ The stall prevention level during acceleration is too low.

- If the value set for L3-02 (stall prevention level during acceleration) is too low, the acceleration time will be too long. Check to be sure that the set value is suitable.

■ The stall prevention level during running is too low.

- If the value set for L3-06 (stall prevention level during running) is too low, the speed will drop before outputting torque. Check to be sure that the set value is suitable.

■ Autotuning not performed during vector control.

- Vector control is not effective without autotuning. Perform autotuning for motor unit separately.

9.2.5 If the Motor Does Not Operate According to Reference

■ The motor runs faster than reference.

1. The frequency reference bias setting is wrong (the gain setting is wrong).

- The frequency reference bias set in constant H3-03 is added to the frequency reference. Check to be sure that the set value is suitable.

2. Frequency bias is set for multi-function analog inputs.

- When "2" (frequency bias) is set for multi-function analog inputs H3-05 and H3-09, a frequency corresponding to the input voltage (current) is added to the frequency reference. Check to be sure that the set value and analog input value are suitable.

3. A signal is being input to the frequency reference (current) terminal 14.

- When "1F" (frequency reference) is set for constant H3-09 (multi-function analog input terminal 14), a frequency corresponding to the terminal 14 input voltage (current) is added to the frequency reference. Check to be sure that the set value and analog input value are suitable.

9.2.6 If the Slip Compensation Function Has Low Speed Precision

- The slip compensation limit has been reached. With the slip compensation function, compensation cannot be carried out beyond the slip compensation limit set in constant C3-03. Check to be sure that the set value is suitable.

9.2.7 If There is Low Speed Control Accuracy at High-speed Rotation in Open-loop Vector Control Mode

- The motor's rated voltage is high.
- The Inverter's maximum output voltage is determined by its input voltage. (For example, if 200 VAC is input, then the maximum output voltage will be 200 VAC.) If, as a result of vector control, the output voltage reference value exceeds the Inverter output voltage maximum value, the speed control accuracy will decrease. Either use a motor with a low rated voltage (i.e., a special motor for use with vector control) or change to flux vector control.

9.2.8 If Motor Deceleration is Slow

■ The deceleration time is long even when control resistance is connected.

1. **“Stall prevention during deceleration enabled” is set.**
 - When control resistance is connected, set constant L3-04 (stall prevention selection during deceleration) to “0” (disabled) or “3” (deceleration stall prevention with braking resistor). When this constant is set to “1” (enabled, the factory-set default), control resistance is not used.
2. **The deceleration time setting is too long.**
 - Check the deceleration time setting (constants C1-02, C1-04, C1-06, and C1-08).
3. **Motor torque is insufficient.**
 - If the constants are correct and there is no overvoltage fault, then the motor’s power is limited. Consider increasing the motor capacity.
4. **The torque limit has been reached.**
 - When a torque limit has been set in constants L7-01 to L7-04, no torque will be output beyond that limit. This can cause the deceleration time to be too long. Check to be sure that the value set for the torque limit is suitable.
 - If the torque limit has been set by multi-function analog inputs H3-05 and H3-09 (set value: 10 to 13), check to be sure that the analog input value is suitable.

■ If the Vertical-axis Load Drops When Brake is Applied

- The sequence is incorrect.
- The Inverter goes into DC injection braking status for 0.5 seconds after deceleration is completed. (This is the factory-set default.)
- To ensure that the brake holds, set frequency detection 2 (H2-01 = 5) for the multi-function contact output terminals (9-10) so that the contacts will OPEN when the output frequency is greater than L4-01 (3.0 to 5.0 Hz). (The contacts will close below L4-01.)
- There is hysteresis in frequency detection 2 (L4-02 = 2.0 Hz). Change the setting to approximately 0.5 Hz if there are drops during stop. Do not use the “running” signal (H2-01 = 0) for the brake ON/OFF signal.

9.2.9 If the Motor Overheats

■ The load is too big.

- If the motor load is too heavy and the motor is used with the effective torque exceeding the motor’s rated torque, the motor will overheat. Some motor ratings are given for short period performance and are not continuous ratings. Reduce the load amount by either lightening the load or lengthening the acceleration/ deceleration time. Also consider increasing the motor capacity.

■ The ambient temperature is too high.

- The motor rating is determined within a particular ambient operating temperature range. The motor will burn out if it is run continuously at the rated torque in an environment in which the maximum ambient operating temperature is exceeded. Lower the motor’s ambient temperature to within the acceptable ambient operating temperature range.

■ The withstand voltage between the motor phases is insufficient.

- When the motor is connected to the Inverter output, a surge is generated between the Inverter switching and the motor coil. Normally the maximum surge voltage is three times the Inverter’s input power supply voltage (i.e., 1,200 V for 400 V class). Be sure to use a motor with a withstand voltage between the motor phases that is greater than the maximum surge voltage. In particular, when using a 400 V class Inverter, use a special motor for Inverters.

■ Autotuning not performed during vector control.

- Vector control is not effective without autotuning. Perform autotuning for motor unit separately.

9.2.10 If There is Noise When the Inverter is Started or From an AM Radio

- If noise is generated by Inverter switching, implement the following countermeasures:
 - Lower the Inverter’s carrier frequency (constant C6-01). This will help to some extent by reducing the amount of internal switching.
 - Install an Input Noise Filter at the Inverter’s power supply input area.
 - Install an Output Noise Filter at the Inverter’s power supply output area.
 - Use metal tubing. Electric waves can be shielded by metal, so encase the Inverter with metal (steel).
 - Ground the Inverter and motor.
 - Separate main circuit wiring from control wiring.

9.2.11 If the Ground Fault Interrupter Operates When the Inverter is Run

- The Inverter performs internal switching, so there is a certain amount of leakage current. This may cause the ground fault interrupter to operate and cut off the power supply. Change to a ground fault interrupter with a high leakage detection level (i.e., a sensitivity current of 200 mA or greater per Unit, with an operating time of 0.1 s or more), or one that incorporates high frequency countermeasures (i.e., one designed

for use with Inverters). It will also help to some extent to lower the Inverter's carrier frequency (constant C6-01).

In addition, remember that the leakage current increases as the cable is lengthened.

9.2.12 If There is Mechanical Oscillation

■ The machinery is making unusual sounds.

1. There may be resonance between the mechanical system's characteristic frequency and the carrier frequency.

- If the motor is running with no problems and the machinery is oscillating with a high-pitched whine, it may indicate that this is occurring. To prevent this type of resonance, adjust the carrier frequency with constants C6-01 to C6-03.

2. There may be resonance between a machine's characteristic frequency and the output frequency of the Inverter.

- To prevent this from occurring, either use the jump frequency functions in constants d3-01 to d3-04 or install rubber padding on the motor base to reduce oscillation.

■ Oscillation and hunting are occurring with open-loop vector control.

- The gain adjustment may be insufficient. Reset the gain to a more effective level by adjusting constants C4-02 (torque compensation time constant), C8-08 (AFR gain), and C3-02 (slip compensation primary delay time) in order. Lower the gain setting and raise the primary delay time setting.
- Vector control is not effective without autotuning. Perform autotuning for motor unit separately.

■ Oscillation and hunting are occurring with flux vector control.

- The gain adjustment may be insufficient. Adjust the various types of speed control loop (ASR) gain. (For details, refer to page - 34.)
- If the mechanical system's resonance point coincides with the Inverter's operating frequency and the oscillation cannot be eliminated in this way, increase the ASR primary delay time (constant C5-06) and then try adjusting the gain again.
- Vector control is not effective without autotuning. Perform autotuning for motor unit separately.

■ Autotuning not performed during vector control.

- Vector control is not effective without autotuning. Perform autotuning for motor unit separately, or set control method selection (A1-02) to V/f control.

9.2.13 If the Motor Rotates Even When Inverter Output is Stopped

- The DC injection braking is insufficient. If the motor continues operating at low speed, without completely stopping, and after a deceleration stop has been executed, it means that the DC injection braking is not decelerating enough. Adjust the DC injection braking as follows:
 - Increase the constant b2-02 (DC injection braking current) setting.
 - Increase the constant b2-04 (DC injection braking time at stop) setting.

9.2.14 If 0 V is Detected When the Fan is Started, or Fan Stalls

- Generation of 0 V and stalling can occur if the fan is turning when it is started. The DC injection braking is insufficient when starting.
- This can be prevented by slowing fan rotation by DC injection braking before starting the fan. Increase the constant b2-03 (DC injection braking time at start) setting.

Line id: @zzzz

www.repairtw.com

9.2.15 If Output Frequency Does Not Rise to Frequency Reference

■ The frequency reference is within the jump frequency range.

- When the jump frequency function is used, the output frequency does not change within the jump frequency range.
- Check to be sure that the jump frequency (constants d3-01 to d3-03) and jump frequency width (constant d3-04) settings are suitable.

■ The frequency reference upper limit has been reached.

- The output frequency upper limit is determined by the following formula:
Maximum output frequency (E1-04) × Frequency reference upper limit (d2-01) / 100
- Check to be sure that the constant E1-04 and d2-01 settings are suitable.

9.2.16 Winding change error has occurred

■ The motor does not perform winding change.

- Magnetic contactor excitation is not performed properly. Check power supply to magnetic contactor.
- Magnetic contactor is wired incorrectly. Check the wiring and correct the cause.
- Magnetic contactor is not working. Replace the magnetic contactor with a new one.
- The winding change signals are not received properly (When winding change is selected.) Check the constant settings.
- Winding change frequency (P1-01) and winding change hysteresis (P1-02) are not set properly. Adjust the constant settings.
- Max. output frequency (E1-04) and Motor 2 max. output frequency are not set properly. Adjust the settings.

■ Clicking sound from magnetic contactor

- One of the following constants is not set properly: Min. baseblock time (L2-03), Voltage recovery time (L2-04), Speed search deceleration time (b3-03), or Acceleration time (C1-01). Check the constants and adjust the settings.

■ OV (Overvoltage) is detected during winding change.

- Voltage recovery time (L2-04) is set too low. Verify the setting.

■ OC (Overcurrent) is detected during winding change.

- Either Min. baseblock time (L2-03) or Voltage recovery time (L2-04) is set too low. Verify the settings.

上正科技有限公司

購買、維修 此手冊零組件

電話： 037-466333

Email: service@repairtw.com

Line id: @zzzz

www.repairtw.com

10

Maintenance and Inspection

This chapter describes basic maintenance and inspection for the VS-626MCS.

10.1 Maintenance and Inspection	10 - 3
10.1.1 Daily Inspection	10 - 3
10.1.2 Periodic Inspection	10 - 3
10.1.3 Periodic Maintenance of Parts	10 - 3

上正科技有限公司

購買、維修 此手冊零組件

電話： 037-466333

Email: service@repairtw.com

Line id: @zzzz

www.repairtw.com



WARNING

- Do not touch the Inverter terminals. Some of the terminals carry high voltages and are extremely dangerous.
Doing so can result in electric shock.
- Always have the protective cover in place when power is being supplied to the Inverter. When attaching the cover, always turn OFF power to the Inverter through the MCCB.
Doing so can result in electric shock.
- After turning OFF the main circuit power supply, wait until the CHARGE indicator light goes out before performance maintenance or inspections.
The capacitor will remain charged and is dangerous.
- Maintenance, inspection, and replacement of parts must be performed only by authorized personnel. Remove all metal objects, such as watches and rings, before starting work. Always use grounded tools.
Failure to heed these warning can result in electric shock.



CAUTION

- A CMOS IC is used in the control board. Handle the control board and CMOS IC carefully. The CMOS IC can be destroyed by static electricity if touched directly.
The CMOS IC can be destroyed by static electricity if touched directly.
- Do not change the wiring, or remove connectors or the Digital Operator, during operation.
Doing so can result in personal injury.

上正科技有限公司

購買、維修 此手冊零組件

電話： 037-466333

Email: service@repairtw.com

Line id: @zzzz

www.repairtw.com

10.1 Maintenance and Inspection

The maintenance period of the Inverter is as follows:

Maintenance Period: Within 18 months of shipping from the factory or within 12 months of being delivered to the final user, whichever comes first.

10.1.1 Daily Inspection

Check the following items with the system in operation.

- The motor should not be vibrating or making unusual noises.
- There should be no abnormal heat generation.
- The ambient temperature should not be too high.
- The output current value shown on the monitor display should not be higher than normal.
- The cooling fan on the bottom of the Inverter should be operating normally.

10.1.2 Periodic Inspection

Check the following items during periodic maintenance.

Always turn OFF the power supply before beginning inspection. Confirm that the LED indicators on the front cover have all turned OFF, and then wait until at least one minute (or at least three minutes for Inverters of 30 kW or more) has elapsed before beginning the inspection. Be sure not to touch terminals right after the power has been turned off. Doing so can result in electric shock.

Table 10.1 Periodic Inspections

Item	Inspection	Corrective Procedure
External terminals, mounting bolts, connectors, etc.	Are all screws and bolts tight?	Tighten loose screws and bolts firmly.
	Are connectors tight?	Reconnect the loose connectors.
Cooling fins	Are the fins dirty or dusty?	Clean off any dirt and dust with an air gun using dry air at a pressure of 39.2×10^4 to 58.8×10^4 Pa (4 to 6 kg cm ²).
PCBs	Is there any conductive dirt or oil mist on the PCBs?	Clean off any dirt and dust with an air gun using dry air at a pressure of 39.2×10^4 to 58.8×10^4 Pa (4 to 6 kg cm ²). Replace the boards if they cannot be made clean.
Cooling fan	Is there any abnormal noise or vibration or has the total operating time exceeded 20,000 hours?	Replace the cooling fan.
Power elements	Is there any conductive dirt or oil mist on the elements?	Clean off any dirt and dust with an air gun using dry air at a pressure of 39.2×10^4 to 58.8×10^4 Pa (4 to 6 kg cm ²).
Smoothing capacitor	Are there any irregularities, such as discoloration or odor?	Replace the capacitor or Inverter.

10.1.3 Periodic Maintenance of Parts

The Inverter is configured of many parts, and these parts must be operating properly in order to make full use of the Inverter functions.

Among the electronic components, there are some that require maintenance depending on their usage conditions. In order to keep the Inverter operating normally over a long period of time, it is necessary to perform period inspections and replace parts according to their service life.

Periodic inspection standards vary depending the Inverter's installation environment and usage conditions. The Inverter's maintenance periods are noted below. Keep them as reference.

Table 10.2 Part Replacement Guidelines

Part	Standard Replacement Period	Replacement Method
Cooling fan	2 to 3 years	Replace with new part.
Smoothing capacitor	5 years	Replace with new part. (Determine need by inspection.)
Breaker relays	—	Determine need by inspection.
Fuses	10 years	Replace with new part.
Aluminum capacitors on PCBs	5 years	Replace with new board. (Determine need by inspection.)

Note Usage conditions are as follows:
 Ambient temperature: Yearly average of 30°C
 Load factor: 80% max.
 Operating rate: 12 hours max. per day

11

Specifications

This chapter describes the basic specifications of the VS-626MC5 and specifications for options and peripheral devices.

11.1 Standard Inverter Specifications	11 - 2
11.2 Specifications of Options and Peripheral Devices	11 - 6

上正科技有限公司

購買、維修 此手冊零組件

電話： 037-466333

Email: service@repairtw.com

Line id: @zzzz

www.repairtw.com

11.1 Standard Inverter Specifications

Table 11.1 200 V Class Inverters

Model number CIMR-MCSA <input type="checkbox"/>	20P4	20P7	21P5	22P2	23P7	25P5	27P5	2011	2015	2018	2022	2030	2037	2045	2055	2075	
Max. applicable motor output (kW)	0.4	0.75	1.5	2.2	3.7	5.5	7.5	11	15	18.5	22	30	37	45	55	75	
O	Rated output capacity (kVA)	1.2	2.3	3.0	4.2	6.7	9.5	13	19	24	30	37	50	61	70	85	110
	Rated output current (A)	3.2	6	8	11	17.5	25	33	49	64	80	96	130	160	183	224	300
	Max. output voltage (V)	3-phase, 200 to 230 VAC (Proportional to input voltage.)															
	Rated output frequency (Hz)	Up to 400 Hz (available by programming)															
Pc	Voltage (V) Frequency (Hz)	3-phase, 200 to 230 VAC, 50/60 Hz															
	Allowable voltage fluctuation	+10%, -15%															
	Allowable frequency fluctuation	5%															
Cc	Control method	Sine wave PWM															
	Torque characteristics	150% at 1 Hz (150% at 0 r/min with PG). ²															
	Speed control range	1: 100 (1: 1000 with PG) ²															
	Speed control accuracy	0.2% ($\pm 0.02\%$ with PG) ²															
	Speed control response	5 Hz (30 Hz with PG) ²															
	Torque limits	Provided (4 quadrant steps can be changed by Cconstant settings.)															
	Torque accuracy	5%															
	Frequency control range	0.1 to 400 Hz															
	Frequency accuracy (temperature characteristics)	Digital references: 0.01% (-10 to +40) Analog references: 0.1% (25 10)															
	Frequency setting resolution	Digital references: 0.01 Hz Analog references: 0.03 Hz/60 Hz (11 bits \pm sign)															
	Output frequency resolution	0.001 Hz															
	Overload capacity	150% of rated current for one minute															
Frequency setting signal	-10 to 10 V, 0 to 10 V, 4 to 20 mA																
Acceleration/Deceleration time	0.01 to 6000.0 s (4 selectable combinations of independent acceleration and deceleration settings)																
Braking torque	Approximately 20%																
Motor protection	Protection by electronic thermal overload relay.																
Instantaneous over-current protection	Stops at approx. 200% of rated output current.																
Fuse blown protection	Stops for fuse blown.																
Overload protection	Stops in one minute at approx. 150% of rated output current.																
Overvoltage protection	Stops when main-circuit DC voltage is approx. 410 V.																
Undervoltage protection	Stops when main-circuit DC voltage is approx. 190 V.																
Pr	Momentary power loss redethru	Stops for 15 ms or more. By selecting the momentary power loss mode, operation can be continued if power is restored within 2 s.															
	Cooling fin overheating	Protection by thermistor.															
	Stall prevention	Stall prevention during acceleration, deceleration, or running.															
	Grounding protection	Protection by electronic circuits. (Overcurrent level)															
	Charge indicator (internal LED)	Lit when the main circuit DC voltage is approx. 50 V or more.															

Model number CIMR-MCSA <input type="checkbox"/>	20P4	20P7	21P5	22P2	23P7	25P5	27P5	2011	2015	2018	2022	2030	2037	2045	2055	2075
Ambient operating temperature	-10° to 40°C (Enclosed wall-mounted type) 10° to 45°C (Open chassis type)															
Ambient operating humidity	90 % RH max.															
Storage temperature	-20 to +60															
Application site	Indoor (no corrosive gas, dust, etc.)															
Altitude	1000 m max.															
Vibration	10 to 20 Hz, 9.8 m/s ² (1G) max.; 20 to 50 Hz, 2 m/s ² (0.2G) max															

* 1. The maximum applicable motor output is given for a standard 4-pole Yaskawa motor. When selecting the actual motor and Inverter, be sure that the Inverter's rated current is applicable for the motor's rated current.

* 2. Tuning is sometimes required.

上正科技有限公司

購買、維修 此手冊零組件

電話： 037-466333

Email: service@repairtw.com

Line id: @zzzz

www.repairtw.com

Table 11.2 400 V Class Inverters

Model number CIMR-MCSA <input type="checkbox"/>	40P4	40P7	41P5	42P2	43P7	45P5	47P5	4011	4015	4018	4022	4030	4037	4045	4055	4075	
Max. applicable motor output (kW)	0.4	0.75	1.5	2.2	3.7	5.5	7.5	11	15	18.5	22	30	37	45	55	75	
O _c	Rated output capacity (kVA)	1.4	2.6	3.7	4.7	6.1	11	14	21	26	31	37	50	61	73	98	130
	Rated output current (A)	1.8	3.4	4.8	6.2	8	14	18	27	34	41	48	65	80	96	128	165
	Max. output voltage (V)	3-phase, 380 to 460 VAC (Proportional to input voltage.)															
	Rated output frequency (Hz)	Up to 400 Hz (available by programming.)															
P _c	Voltage (V) Frequency (Hz)	3-phase, 380 to 460 VAC, 50/60 Hz															
	Allowable voltage fluctuation	+10%, -15%															
	Allowable frequency fluctuation	5%															
	Control method	Sine wave PWM															
	Torque characteristics	150% at 1 Hz (150% at 0 r/min with PG.)															
	Speed control range	1: 100 (1: 1000 with PG)* ²															
	Speed control accuracy	0.2% (0.02% with PG)* ²															
	Speed control response	5 Hz (30 Hz with PG)* ²															
	Torque limits	Provided (4 quadrant steps can be changed by constant settings.)															
	Torque accuracy	5%															
C _c	Frequency control range	0.1 to 400 Hz															
	Frequency accuracy (temperature characteristics)	Digital references: 0.01% (-10 to +40) Analog references: 0.1% (25 10)															
	Frequency setting resolution	Digital references: 0.01 Hz Analog references: 0.03 Hz/60 Hz (11 bits + sign)															
	Output frequency resolution	0.001 Hz															
	Overload capacity	150% of rated current for one minute															
	Frequency setting signal	-10 to 10 V, 0 to 10 V, 4 to 20 mA															
	Acceleration/Deceleration time	0.01 to 6000.0 s (4 selectable combinations of independent acceleration and deceleration settings)															
	Braking torque	Approximately 20%															
	Motor protection	Protection by electronic thermal overload relay.															
	Instantaneous over-current protection	Stops at approx. 200% of rated output current.															
	Fuse blown protections	Stops for fuse burnout.															
	Overload protection	Stops in one minute at approx. 150% of rated output current.															
	Overvoltage protection	Stops when main-circuit DC voltage is approx. 820 V.															
P _t	Undervoltage protection	Stops when main-circuit DC voltage is approx. 380 V.															
	Momentary power loss redethru	Stops for 15 ms or more. By selecting the momentary power loss mode, operation can be continued if power is restored within 2 s.															
	Cooling fan overheating	Protection by thermistor.															
	Stall prevention	Stall prevention during acceleration, deceleration, or running.															
	Grounding protection	Protection by electronic circuits. (Overcurrent level)															
	Charge indicator (internal LED)	Lit when the main circuit DC voltage is approx. 50 V or more.															

Model number CIMR-MCSA <input type="checkbox"/>	40P4	40P7	41P5	42P2	43P7	43P5	47P5	4011	4015	4018	4022	4030	4037	4045	4055	4075
Ambient operating temperature	-10 to 40 (Enclosed wall-mounted type) -10 to 45 (Open chassis type)															
Ambient operating humidity	90% RH max.															
Er Storage temperature	-20 to +60															
Application site	Indoor (no corrosive gas, dust, etc.)															
Altitude	1000 m max.															
Vibration	10 to 20 Hz, 9.8 m/s ² [1G] max.; 20 to 50 Hz, 2 m/s ² [0.2G] max															

* 1. The maximum applicable motor output is given for a standard 4-pole Yaskawa motor. When selecting the actual motor and Inverter, be sure that the Inverter's rated current is applicable for the motor's rated current.

* 2. Tuning is sometimes required.

上正科技有限公司

購買、維修 此手冊零組件

電話： 037-466333

Email: service@repairtw.com

Line id: @zzzz

www.repairtw.com

11.2 Specifications of Options and Peripheral Devices

The following options and peripheral devices can be used for the VS-626MC5. Select them according to the application.

Table 11.3 Options and Peripheral Devices

Purpose	Name	Model (Code)	Descriptions
Protect Inverter wiring	MCCB or Ground Fault Interrupter	NF *1	Always connect a breaker to the power supply line to protect Inverter wiring. Use a ground fault interrupter suitable for high frequencies.
Prevents burning when a Braking Resistor is used.	Magnetic Contactor	HI- E	Install to prevent the braking resistor from burning out when one is used. Always attach a surge absorber to the coil.
Contains switching surge	Surge Absorber	DCR2-	Absorbs surge from the magnetic contactor and control relays. Connect surge absorbers to all magnetic contactors and relays near the inverter.
Isolates I/O signals	Isolator	DGP	Isolates the I/O signals of the Inverter and is effective against inductive noise.
Improve the input power factor of the Inverter	DC Reactor AC Reactor	UZDA- UZBA-	Used to improve the input power factor of the Inverter. All VS-626MC5 Inverters of 18.5 kW or higher contain built-in DC reactors. These are optional for Inverters of 15 kW or less. Install DC and AC reactors for applications with a large power supply capacity (600 kVA or higher).
Reduce the affects of radio and control device noise	Input Noise Filter	Single-phase: LNFB- 3-phase: LNFD- HF	Reduces noise coming into the inverter from the power supply line and to reduce noise flowing from the inverter into the power supply line. Connect as close to the Inverter as possible.
	Output Noise Filter	LF-	Reduces noise generated by the Inverter. Connect as close to the Inverter as possible.
Enable stopping the machine in a set time	Braking Resistor	ERF-150WJ (R00)	Consumes the regenerative motor energy with a resistor to reduce deceleration time (use rate: 3% ED).
	Braking Resistor Unit	LKEB- (75600-K 0)	Consumes the regenerative motor energy with a resistor to reduce deceleration time (use rate: 10% ED).
	Braking Unit	CDBR- (72600-R 0)	Used with a Braking Resistor Unit to reduce the deceleration time of the motor.
Operates the Inverter externally	VS Operator*2 (small plastic Operator)	JVOP-95 (73041-0905X-)	Allows frequency reference settings and ON/OFF operation control to be performed by analog references from a remote location (50 m max.). Frequency counter specifications: 60/120 Hz, 90/180Hz
	VS Operator (Standard steel-plate Operator)	JVOP-96 (73041-0906X-)	Allows frequency reference settings and ON/OFF operation control to be performed by analog references from a remote location (50 m max.). Frequency counter specifications: 75 Hz, 150 Hz, 220 Hz
	Digital Operator Connection Cable	1 m cable: (72616-W5001) 3 m cable: (72616-W5003)	Extension cable to use a Digital Operator remotely. Cable length: 1 m or 3 m
Controls an Inverter system	VS System Module	JGSM-	A system controller that can be match to the automatic control system to produce an optimum system configuration.
Provides Inverter momentary power loss recovery time	Momentary Power Loss Recovery Unit	P00 0 (73600-P00 0)	Handles momentary power losses for the control power supply (maintains power for 2 s).
Set/monitor frequencies and voltages externally.	Frequency Meter	DCF-6A	Devices to set or monitor frequencies externally.
	Frequency Setter	RV30YN20S (2 R)	
	Frequency Setter Knob	CM-3S	
	Output Voltmeter	SCF-12NH	Measures the output voltage externally and designed for use with a PWM Inverter.
Correct frequency reference input, frequency meter, ammeter scales	Variable Resistor Board for Frequency Reference	2 k : (ETX003270) 20 k : (ETX003120)	Connected to the control circuit terminals to input a frequency reference.
	Frequency Meter Scale Correction Resistor	RH000850	Calibrates the scale of frequency meters and ammeters.
Performs winding change	Magnetic contactor for winding selection	HV-75AP3 HV-150AP3	Install to perform winding change.

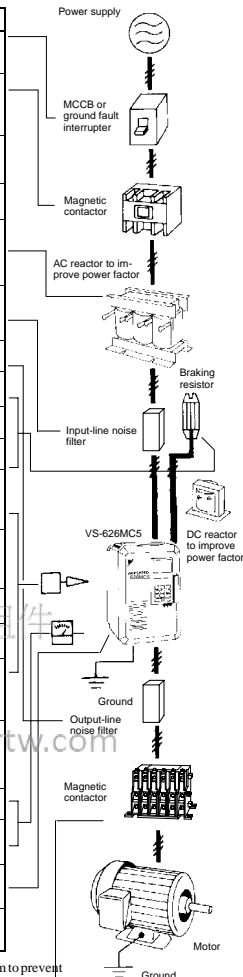

* 1. Use a ground fault interrupter with a current sensitivity of 200 mA minimum and an operating time of 0.1 s minimum to prevent operating errors. The interrupter must be suitable for high-frequency operation.

* 2. The suffixes of the model and code numbers of VS Operators indicate frequency meters are shown in the following table.

Model No.	Code No.	Frequency Meter Specifications
JVOP-95 1	73041-0905X-01	TRM-45 3 V 1 mA 60/120 Hz
JVOP-95 2	73041-0905X-02	TRM-45 3 V 1 mA 90/180 Hz
JVOP-96 1	73041-0906X-01	DCF-6A 3 V 1 mA 75 Hz

Model No.	Code No.	Frequency Meter Specifications
JVOP-96 2	73041-0906X-02	DCF-6A 3 V 1 mA 150 Hz
JVOP-96 3	73041-0906X-03	DCF-6A 3 V 1 mA 220 Hz

The following Option Cards are available.

Table 11.4 Option Cards

Type	Name	Code No.	Descriptions	Manual No.
S B	Analog Reference Card AI-14U	73600-C001X	Used to set high-accuracy, high-resolution analog speed references. <ul style="list-style-type: none"> Input signal levels: 0 to +10 VDC 20 k 1 channel 4 to 20 mA DC 250 1 channel Input resolution: 14 bits 1/16384 	TOE-C736-30.13
	Analog Reference Card AI-14B	73600-C002X	Used to set high-accuracy, high-resolution analog speed references. <ul style="list-style-type: none"> Input signal level: 0 to 10 VDC 20 k 4 to 20 mA DC 500 3 channels Input resolution: 13 bits + sign 1/8192 	TOE-C736-30.14
	Digital Reference Card DI-08	73600-C003X	Used to set frequency references in 2-digit BCD or 8-bit binary. <ul style="list-style-type: none"> Input signal: 8 bits binary 2 digits BCD + SIGN signal + SET signal Input voltage: +24 V insulated Input current: 8 mA 	TOE-C736-30.15
	Digital Reference Card DI-16H2	73600-C016X	Used to set 16-bit digital speed references. <ul style="list-style-type: none"> Input signal: 16 bits binary 4 digits BCD + SIGN signal + SET signal Input voltage: +24 V insulated Input current: 8 mA Used to set frequency references with 16 or 12 bits (switchable).	TOE-C736-40.7
	RS-232C/485/422 Interface Card SI-K2	73600-C015X	Used to convert RS-232C to RS-485 or RS-422. Supports baud rates up to 9.6 kbps.	TOE-C736-40.6
	Analog Monitor Card AO-08	73600-D001X	Converts analog signals to monitor the Inverter's output status (output frequency, output current, etc.) to absolute values and outputs them. <ul style="list-style-type: none"> Output resolution: 8 bits 1/256 Output voltage: 0 to +10 V not insulated Output channels: 2 channels 	TOE-C736-30.21
	Analog Monitor Card AO-12	73600-D002X	Output analog signals to monitor the Inverter's output status (output frequency, output current, etc.). <ul style="list-style-type: none"> Output resolution: 11 bits 1/2048 + sign Output voltage: 0 to +10 V not insulated Output channels: 2 channels 	TOE-C736-30.22
	Pulse Monitor Card PO-36F	73600-D003X	Used to output pulse-train signals according to the output frequency of the Inverter. <ul style="list-style-type: none"> Output pulse: 1F, 6F, 10F, 12F, 36F F: Output frequency Output voltage: +12 V 10% insulated Output current: 20 mA max. 	TOE-C736-30.23
	Digital Output Card DO-08	73600-D004X	Outputs isolated digital signals to monitor the Inverters operating status (alarm signals, zero speed detection, etc.) <ul style="list-style-type: none"> Output form: Photocoupler output, 6 channels 48 V, 50 mA max. Relay contact output, 2 channels 250 VAC, 1 A max., DC 30V, 1 A max. 	TOE-C736-30.24
	2C-Relay Output Card DO-02C	73600-D007X	Provides two multi-function outputs (DPDT relay contacts) in addition to those provided by the Inverter.	TOE-C736-40.8

Table 11.4 Optional Cards (Continued)

Type	Name	Code No.	Descriptions	Manual No.
E	PG-B2	73600-A013X	<ul style="list-style-type: none"> • Used for flux vector control. • A-, B-phase input (complimentary input) • Maximum input frequency: 32767 Hz • Pulse monitor output: Open-collector (PG power supply output: +12 V, 200 mA max.) 	TOE-C736-40.2
	PG-X2	73600-A015X	Used for flux vector control. <ul style="list-style-type: none"> • A-, B-, Z-phase pulse (differential pulse) input • Maximum input frequency: 300 kHz • Input: Conforms to RS-422 • Pulse monitor output: RS-422 (PG power supply output: +5 or +12 V, 200 mA max.) 	TOE-C736-40.4
	Synchronous Phase Control Card SP-A2	73600-A016X	Connector to Inverter to enable synchronized startup control with the motor. An external voltage detection transformer (CPT005845) is required.	TOE-C736-40.5

上正科技有限公司

購買、維修 此手冊零組件

電話： 037-466333

Email: service@repairtw.com

Line id: @zzzz

www.repairtw.com

12

Appendix

This chapter provides precautions for the Inverter, motor, and peripheral devices and also provides lists of constants.

12.1	Inverter Application Precautions	12 - 2
12.1.1	Selection	12 - 2
12.1.2	Installation	12 - 2
12.1.3	Settings	12 - 3
12.1.4	Handling	12 - 3
12.2	Motor Application Precautions	12 - 4
12.2.1	Using the Inverter for an Existing Standard Motor	12 - 4
12.2.2	Using the Inverter for Special Motors	12 - 5
12.2.3	Power Transmission Mechanism (Speed Reducers, Belts, and Chains)	12 - 5
12.3	Peripheral Device Application Precautions	12 - 6
12.4	Wiring Examples	12 - 8
12.4.1	Using a Braking Resistor Unit	12 - 8
12.4.2	Using a Braking Unit and Braking Resistor Unit	12 - 8
12.4.3	Using Two Braking Units in Parallel	12 - 11
12.4.4	Using Three Braking Resistor Units in Parallel	12 - 12
12.4.5	Using a JVOP-95-□、96-□ VS Operator	12 - 13
12.4.6	Using an Open-collector Transistor for Operation Signals	12 - 14
12.4.7	Using Open-collector, Contact Outputs	12 - 14
12.5	User Constants	12 - 15

www.repairtw.com

12.1 Inverter Application Precautions

12.1.1 Selection

■ Installing Reactors

A large peak current will flow in the power input circuit when the Inverter is connected to a large-capacity power transformer (600 kVA or higher) or when switching a phase capacitor. Excessive peak current can destroy the converter section. To prevent this, install a DC or AC reactor (optional) to improve the power supply power factor.

DC reactors are built into 200 V class Inverters of 18.5 to 75 kW and 400 V class Inverters of 18.5 to 75 kW. If a thyristor converter, such as a DC drive, is connected in the same power supply system, connect a DC or AC reactor regardless of the power supply conditions shown in the following diagram.

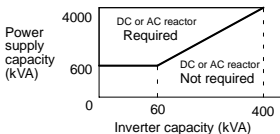

■ Inverter Capacity

When connecting special motors or multiple motors in parallel to an Inverter, select the Inverter capacity so that the rated output current of the Inverter is 1.1 times the sum of all the motor rated currents.

■ Initial Torque

The startup and acceleration characteristics of the motor are restricted by the overload current ratings of the Inverter that is driving the motor. The torque characteristics are generally less than those required when starting using a normal commercial power supply. If a large initial torque is required, select an Inverter with a somewhat larger capacity or increase the capacity of both the motor and the inverter.

■ Emergency Stop

Although the Inverter's protective functions will stop operation when a fault occurs, the motor will not stop immediately. Always provide mechanical stop and protection mechanisms on equipment requiring an emergency stop.

■ Options

Terminals B1 B2 ⊕1 ⊕2 ⊕3 are for connecting only the options specifically provided by Yaskawa. Never connect any other devices to these terminals.

12.1.2 Installation

■ Installation in Enclosures

Either install the inverter in a clean location not subject to oil mist, air-bourne matter, dust, and other contaminants, or install the Inverter in a completely enclosed panel. Provide cooling measures and sufficient panel space so that the temperature surrounding the Inverter does not go beyond the allowable temperature. Do not install the Inverter on wood or other combustible materials.

■ Installation Direction

Mount the Inverter vertically to a wall or other horizontal surface.

12.1.3 Settings

■ Upper Limits

The Digital Operator can be used to set high-speed operation up to a maximum of 400 Hz. Incorrect settings can be dangerous. Use the maximum frequency setting functions to set upper limits. (The maximum output frequency is factory-set to 60 Hz.)

■ DC Injection Braking

The motor can overheat if the DC injection braking voltage or braking time is set to a large value.

■ Acceleration/Deceleration Times

The motor's acceleration and deceleration times are determined by the torque generated by the motor, the load torque, and the load's inertial moment ($GD^2/4$). If the stall prevention functions are activated during acceleration or deceleration, increase the acceleration or deceleration time. The stall prevention functions will increase the acceleration or deceleration time by the amount of time the stall prevention function is active.

To reduce the acceleration or deceleration times, increase the capacity of the motor and Inverter.

12.1.4 Handling

■ Wiring Check

The Inverter will be internally damaged if the power supply voltage is applied to output terminal U, V, or W. Check wiring for any mistakes before supplying power. Check all wiring and sequences carefully.

■ Magnetic Contactor Installation

Do not start and stop operation frequently with a magnetic contactor installed on the power supply line. Doing so can cause the Inverter to malfunction.

■ Inspections

The internal capacitors in the Inverter require time to discharge after the power supply is turned OFF. Do not start inspections until the CHARGE indicator goes out.

■ Wiring UL/C-UL Inverters

Always use closed-loop connectors when wiring Inverters that meet UL or C-UL standards. Always use the crimp tool specified by the manufacturer of the closed-loop connectors.

上正科技有限公司

購買、維修 此手冊零組件

電話： 037-466333

Email: service@repairtw.com

Line id: @zzzz

www.repairtw.com

12.2 Motor Application Precautions

12.2.1 Using the Inverter for an Existing Standard Motor

When a standard motor is operated with the Inverter, power loss is slightly higher than when operated with a commercial power supply. In addition, cooling effects also diminish in the low-speed range, resulting in an increase in the motor temperature. Therefore, the motor torque should be reduced in the low-speed range.

The following graph shows the allowable load characteristics of a standard motor.

If 100% torque is continuously required in the low-speed range, use a special motor for use with inverters.

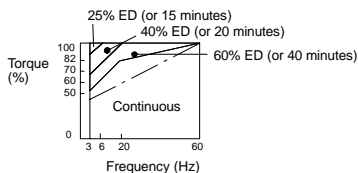

If the input voltage is high (440 V or higher) or the wiring distance is long, the motor insulation voltage must be considered. Contact your Yaskawa representative for details.

■ High-speed Operation

When using the motor at a high speed (60 Hz or more), problems may arise in dynamic balance and bearing durability. Contact your Yaskawa representative for details.

■ Torque Characteristics

The motor may require more acceleration torque when the motor is operated with the Inverter than when operated with a commercial power supply. Check the load torque characteristics of the machine to be used with the motor to set a proper V/f pattern.

■ Vibration

The Inverter uses a high carrier PWM to reduce motor vibration. When the motor is operated with the Inverter, motor vibration is almost the same as when operated with a commercial power supply. Motor vibration may, however, become greater in the following cases.

Resonance with the Natural Frequency of the Mechanical System

Take special care when a machine that has been operated at a constant speed is to be operated in variable speed mode.

If resonance occurs, install vibration-proof rubber on the motor base or use the frequency jump function to skip any frequency resonating the machine.

Imbalanced Rotor

Take special care when the motor is operated at a higher speed (60 Hz or more).

■ Noise

Noise is almost the same as when the motor is operated with a commercial power supply. Motor noise, however, becomes louder when the motor is operated at a speed higher than the rated speed (60 Hz).

Line id: @zzzz

www.repairtw.com

12.2.2 Using the Inverter for Special Motors

■ Pole-changing Motor

The rated input current of pole-changing motors differs from that of standard motors. Select, therefore, an appropriate Inverter according to the maximum input current of the motor to be used.
Before changing the number of poles, always make sure that the motor has stopped. Otherwise, the overvoltage protective or overcurrent protective mechanism will be actuated, resulting in an error.

■ Submersible Motor

The rated input current of submersible motors is higher than that of standard motors. Therefore, always select an Inverter by checking its rated output current.
When the distance between the motor and Inverter is long, use a cable thick enough to connect the motor and Inverter to prevent motor torque reduction.

■ Explosion-proof Motor

When an explosion-proof motor or increased safety-type motor is to be used, it must be subject to an explosion-proof test in conjunction with the Inverter. This is also applicable when an existing explosion-proof motor is to be operated with the Inverter.
Since the Inverter itself is, however, not explosion-proof, always install it in a safe place.

■ Gearmotor

The speed range for continuous operation differs according to the lubrication method and motor manufacturer. In particular, continuous operation of an oil-lubricated motor in the low speed range may result in burning. If the motor is to be operated at a speed higher than 60 Hz, consult with the manufacturer.

■ Synchronous Motor

A synchronous motor is not suitable for Inverter control.
If a group of synchronous motors is individually turned ON and OFF, synchronism may be lost.

■ Single-phase Motor

Do not use an Inverter for a single-phase motor. The motor should be replaced with a 3-phase motor.

12.2.3 Power Transmission Mechanism (Speed Reducers, Belts, and Chains)

If an oil-lubricated gearbox or speed reducer is used in the power transmission mechanism, oil lubrication will be affected when the motor operates only in the low speed range. The power transmission mechanism will make noise and experience problems with service life and durability if the motor is operated at a speed higher than 60 Hz.

上正科技有限公司

購買、維修 此手冊零組件

電話： 037-466333

Email: service@repairtw.com

Line id: @zzzz

www.repairtw.com

12.3 Peripheral Device Application Precautions

■ Selecting and Installing Wiring Breakers

Install a molded-case circuit breaker (MCCB) on the power supply line to the Inverter to protect the wiring. Select the MCCB according to the Inverter's power supply power factor (which changes with the supply voltage, output frequency, and load). Contact your Yaskawa representative for selection standards. Operating characteristics of completely magnetic MCCBs change with high-frequency currents. Select a model with a large capacity. We recommend using only ground fault interrupters designed for inverters.

■ Using Magnetic Contactors on the Power Supply Line

The Inverter can be used without a magnetic contactor on the power supply line. Although a magnetic contactor can be installed to protect from accidents that can occur by automatic recovery following power losses during remote operation, do not start and stop operation frequently with a magnetic contactor installed on the power supply line. Doing so can cause the Inverter to malfunction. The motor will not be automatically restarted after power recovery during Digital Operator operation, and starting via a magnetic contactor is thus not possible.

Although operation can be stopped using a magnetic contactor in the power supply line, the regenerative control of the Inverter will not operate and a coast to a stop will occur. If a Braking Unit or Braking Resistor Unit is used, wire a sequence that turns OFF the magnetic contactor with the thermal protector contact of the Braking Resistor Unit.

■ Using Magnetic Contactors on the Motor Line

As a rule, do not install a magnetic contactor between the Inverter and motor to turn the motor ON and OFF during operation. Supplying power to the motor while the Inverter is operating will cause a large surge current to flow, and the Inverter's overcurrent protection function will operate. If a magnetic contactor is installed to switch to a commercial power supply, switch the lines only after stopping both the Inverter and the motor. Use the speed search function if switching is required while the motor shaft is rotating.

If a magnetic contactor is required for momentary power losses, use a contactor with delayed operation.

■ Installing Thermal Overload Relays

The Inverter has a protection function using an electronic thermal to protect the motor from overheating. However, if more than one motor is operated from one Inverter or if a multi-pole motor is operated, install thermal overload relays or thermal protectors between the Inverter and motors. Set the constant L1-01 to "1" and set the heat-operating thermal overload relay or thermal protector to 1.0 times the value on the motor nameplate at 50 Hz or 1.1 times the value at 60 Hz.

■ Improving the Power Factor (Eliminating Phase Advancing Capacitors)

Install a DC or AC reactor on the power supply line to the Inverter to improve the power factor. (200 V class Inverters of 18.5 to 75kW and 400 V class Inverters of 18.5 to 160kW have built-in DC reactors.)

Capacitors or surge suppressors on the output line from the Inverter can overheat or be destroyed by the high-frequency component of the Inverter's output. They can also cause overcurrents to flow to the Inverter, causing the overcurrent protection function to activate. Do not install capacitors or surge suppressors in the output line.

■ Electromagnetic Interference

The Inverter's I/O circuits (main circuits) contain a high-frequency component, which may adversely affect communications devices (e.g., AM radios) located nearby. This interference can be reduced by installing noise filters, or you can install the wiring between the Inverter and motor and the power supply wiring in a metal duct and ground the duct.

Email: service@repairtw.com

Line id: @zzzz

www.repairtw.com

■ Wire Sizes and Distances

Motor torque will be reduced by voltage drop along the cable if the distance between the Inverter and the motor is too long. This is particularly noticeable for low-frequency outputs. Use wires of sufficient size.

Always use the optional extension cables when operating the Digital Operator separated from the Inverter. For remote operation using analog signals, keep the control line length between the Analog Operator or operation signals and the Inverter to 50 m or less, and separate the lines from high-power lines (main circuits or relay sequence circuits) to reduce induction from peripheral devices.

When setting frequencies from an external frequency setter (and not from a Digital Operator), use shielded twisted-pair wires and ground the shield to terminal 12, as shown in the following diagram.

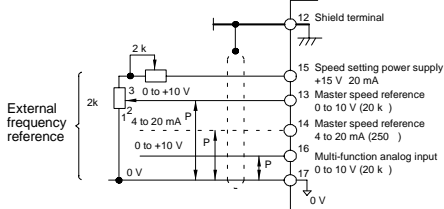

上正科技有限公司

購買、維修 此手冊零組件

電話： 037-466333

Email: service@repairtw.com

Line id: @zzzz

www.repairtw.com

12.4 Wiring Examples

12.4.1 Using a Braking Resistor Unit

CIMR-MC5A20P4 to -MC5A27P5 (200 V class Inverters of 0.4 to 7.5 kW)
 CIMR-MC5A40P4 to -MC5A4015 (400 V class Inverters of 0.4 to 15 kW)

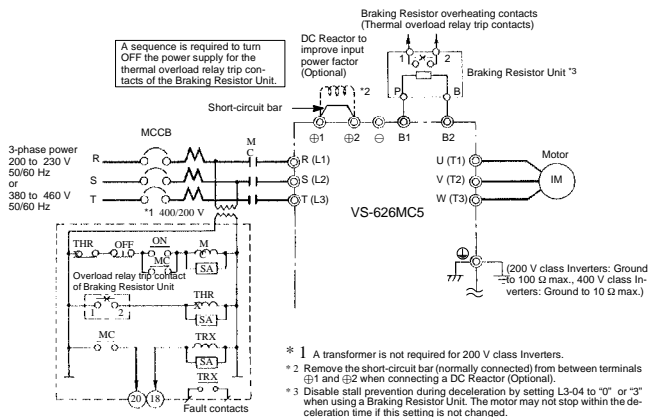

12.4.2 Using a Braking Unit and Braking Resistor Unit

CIMR-MC5A2011 -MC5A2015 (200 V class Inverters of 11 kW 15 kW)

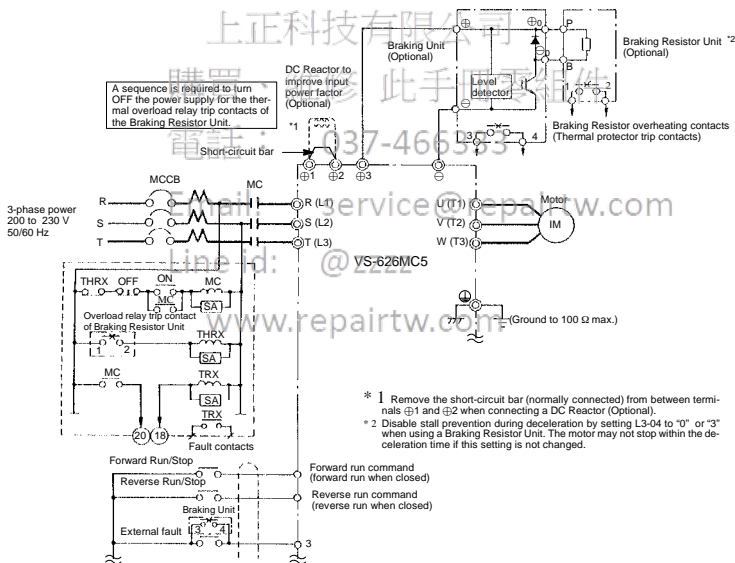

CIMR-MC5A2018 -MC5A2022 (200 V class Inverters of 18.5 kW 22 kW)

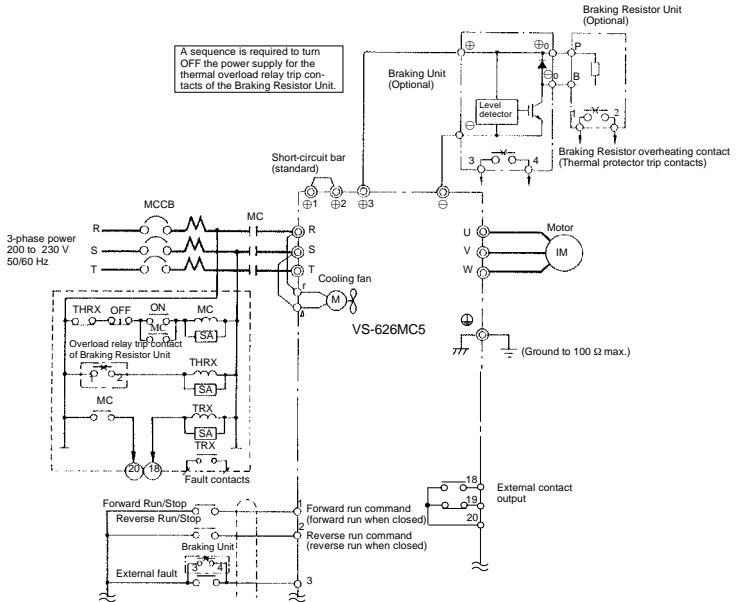

Disable stall prevention during deceleration by setting L3-04 to "0" or "3" when using a Braking Resistor Unit. The motor may not stop within the deceleration time if this setting is not changed.

上下科技有限公司

購買、維修 此手冊零組件

電話： 037-466333

Email: service@repairtw.com

Line id: @zzzz

www.repairtw.com

12.4.3 Using Two Braking Units in Parallel

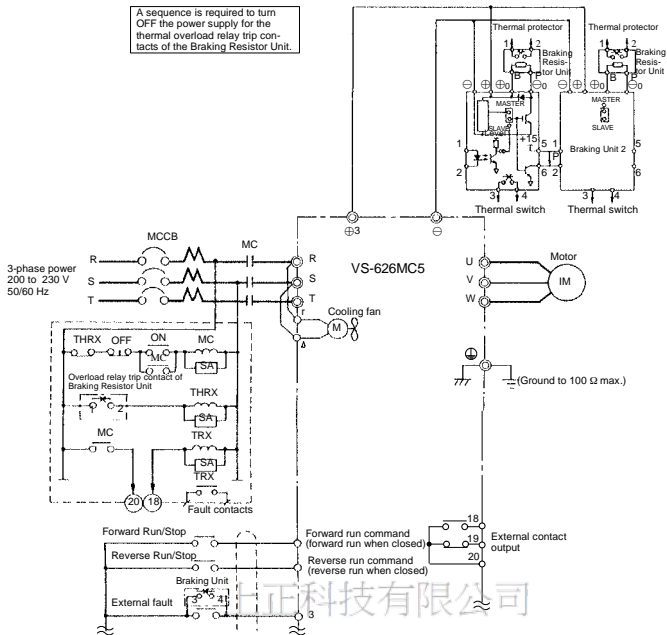

Disable stall prevention during deceleration by setting L3-04 to "0" or "3" when using a Braking Resistor Unit. The motor may not stop within the deceleration time if this setting is not changed.

電話： 037-466333

Email: service@repairtw.com

Line id: @zzzz

www.repairtw.com

12.4.4 Using Three Braking Resistor Units in Parallel

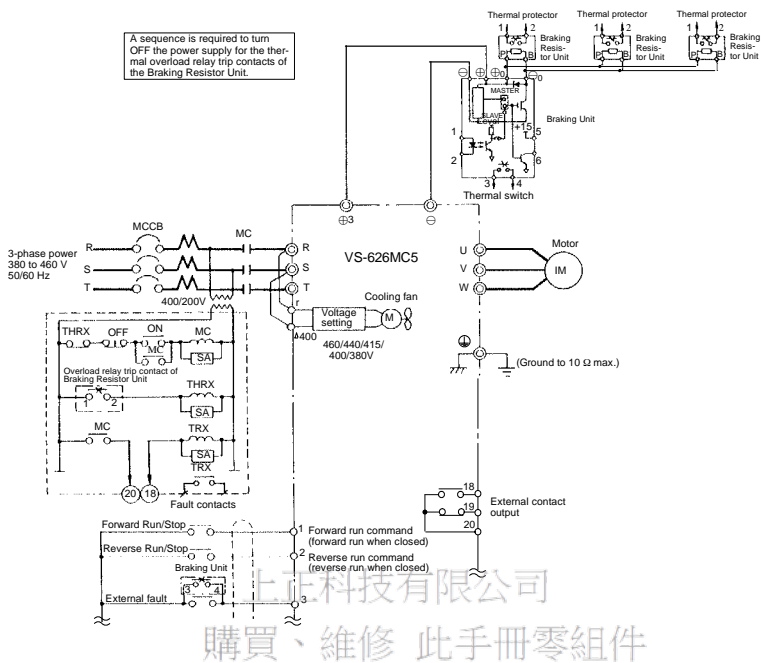

Disable stall prevention during deceleration by setting L3-04 to "0" or "3" when using a Braking Resistor Unit. The motor may not stop within the deceleration time if this setting is not changed.

電話： 037-466333

Email: service@repairtw.com

Line id: @zzzz

www.repairtw.com

12.4.5 Using a JVOP-95-□, -96-□ VS Operator

CIMR-MC5A27P5 (200 V class Inverters of 7.5 kW)

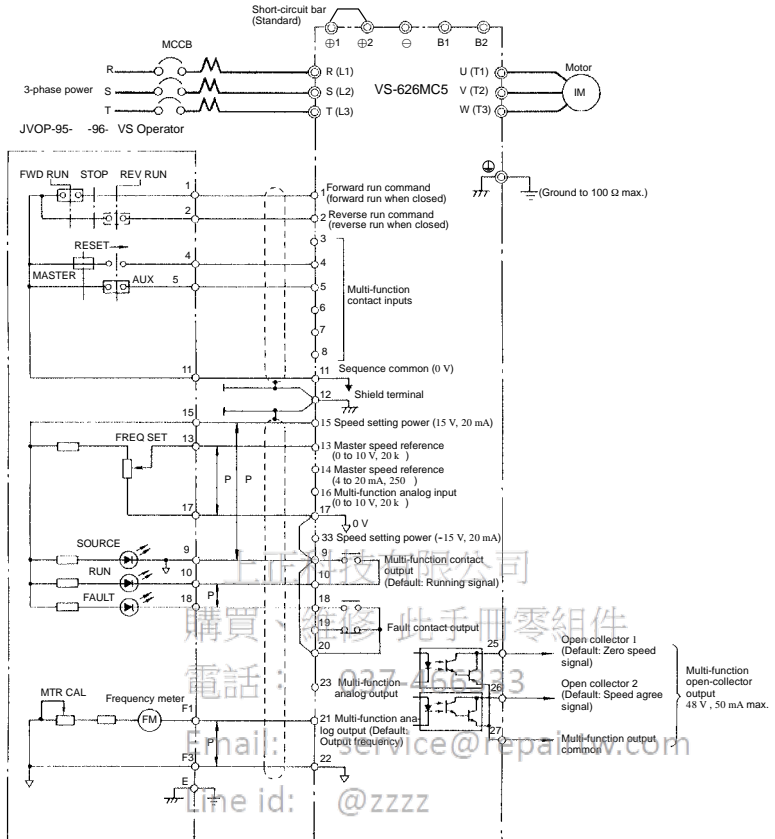

12.4.6 Using an Open-collector Transistor for Operation Signals

CIMR-MC5A27P5 (200 V class Inverters of 7.5 kW)

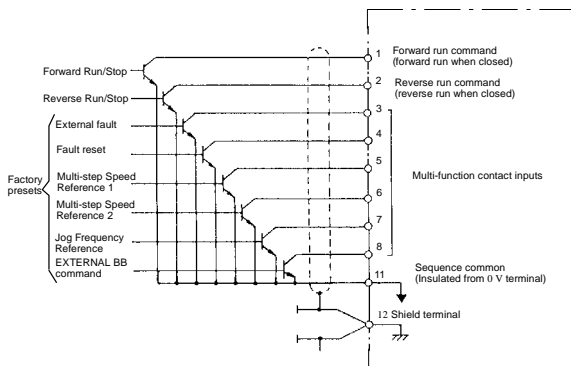

12.4.7 Using Open-collector, Contact Outputs

CIMR-MC5A27P5 (200 V class Inverters of 7.5 kW)

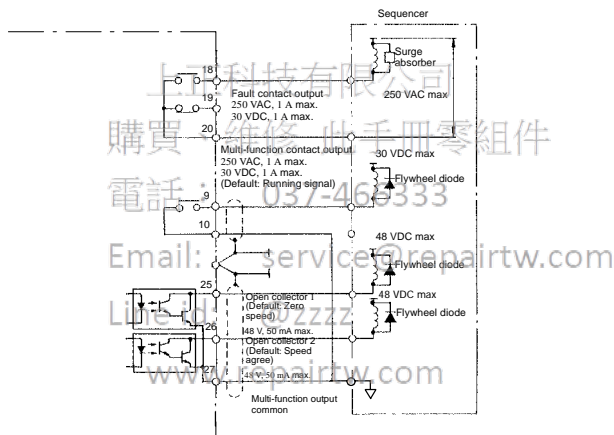

12.5 User Constants

Factory settings are given for a 200 V class Inverter of 0.4 kW set to open loop vector control (A1-02 = 2).

Table 12.1 User Constants

No.	Name (Display)	Factory Setting	Setting	No.	Name (Display)	Factory Setting	Setting
A1-00	Language selection for digital operator display (Select Language)	1 ₁		b5-08	-- 4	0.00	
A1-01	Constant access level (Access Level)	2		b6-01	-- 4	0.0	
A1-02	Control method selection (Control Method)	2 ₁		b6-02	-- 4	0.0	
A1-03	Initialize (Init Parameters)	0		b6-03	-- 4	0.0	
A1-04	Password 1 (Enter Password)	0		b6-04	-- 4	0.0	
A1-05	Password 2 (Select Password)	0		b7-01	-- 4	0.0	
A2-01 to A2-32	User setting constant (User Prm 1 to 32)			b7-02	-- 4	0.05	
b1-01	Reference selection (Reference Source)	1		C1-01	Acceleration time 1 (Accel Time 1)	10.0	
b1-02	Operation method selection (Run Source)	1		C1-02	Deceleration time 1 (Decel Time 1)	10.0	
b1-03	Stopping method selection (Stopping Method)	0		C1-03	Acceleration time 2 (Accel Time 2)	10.0	
b1-04	Prohibition of reverse operation (Reverse Oper)	0		C1-04	Deceleration time 2 (Decel Time 2)	10.0	
b1-05	Operation selection for setting of E1-09 or less (Zero-Speed Oper)	0		C1-05	Deceleration time 2 (Decel Time 2)	10.0	
b1-06	Read sequence input twice (Cnt1 Input Scans)	1		C1-06	Acceleration time 3 (Accel Time 3)	10.0	
b1-07	Operation after switching to remote mode ^{*2} (LOC/REM RUN Sel)	0		C1-07	Acceleration time 4 (Accel Time 4)	10.0	
b1-08	Run command selection for PRG mode (RUN CMD at PRG)	0		C1-08	Deceleration time 4 (Decel Time 4)	10.0	
b2-01	Zero speed level (DC injection braking start frequency) (DCInj Start Freq)	0.5		C1-09	Emergency stop time (Fast Stop Time)	10.0	
b2-02	DC injection braking current (DCInj Current)	50		C1-10	Accel/decel time setting unit (Acc/Dec Units)	1	
b2-03	DC injection braking time at start (DCInj Time @ Start)	0.00		C1-11	Accel/decel time switching frequency (Acc/Dec SW Freq)	0.0	
b2-04	DC injection braking time at stop (DCInj Time @ Stop)	0.50		C2-01	S-curve characteristic time at acceleration start (SCrv Acc @ Start)	0.20	
b3-01	Speed search selection at start (SpdSrch at Start)	0 ₃		C2-02	S-curve characteristic time at acceleration end (SCrv Acc @ End)	0.20	
b3-02	Speed search operating current (SpdSrch Current)	100 ₃		C2-03	S-curve characteristic time at deceleration start (SCrv Dec @ Start)	0.20	
b3-03	Speed search deceleration time (SpdSrch Dec Time)	2.0		C2-04	S-curve characteristic time at deceleration end (SCrv Dec @ End)	0.00	
b4-01	Timer function ON-delay time (Delay-ON Timer)	0.0		C3-01	Slip compensation gain (Slip Comp Gain)	1.0 ₃	
b4-02	Timer function OFF-delay time (Delay-OFF Timer)	0.0		C3-02	Slip compensation primary delay time (Slip Comp Time)	200 ₃	
b5-01	-- 4	0		C3-03	Slip compensation limit (Slip Comp Limit)	200	
b5-02	-- 4	1.00		C3-04	Slip compensation during regeneration (Slip Comp Regen)	0V	
b5-03	-- 4	1.0		C3-05	Flux calculation method (Flux Select)	0	
b5-04	-- 4	100.0		C3-06	Output voltage limited operation selection (Output V Limit)	0	
b5-05	-- 4	0.00		C4-01	Torque compensation gain (Torq Comp Gain)	1.00	
b5-06	-- 4	100.0		C4-02	Torque compensation time constant (Torq Comp Time)	20 ₃	
b5-07	-- 4	0.0		C4-03	Start torque compensation (forward direction) (F TorqCmp @ Start)	0.0	

* 1. Not initialized. (Japanese standard specifications: A1-01 = 1, A1-02 = 2)

* 2. Not displayed for some models depending on software version No.

* 3. Factory setting depends on the control method (A1-02).

* 4. Constants that cannot be used. (Do not change the settings)

Table 12.1 User Constants (Continued)

No.	Name (Display)	Factory Setting	Setting	No.	Name (Display)	Factory Setting	Setting
C4-04	Start torque compensation (reverse direction) (R TorqCmp @ Start)	0.0		d3-04	Jump frequency width (Jump Bandwidth)	1.0	
C4-05	Start torque time constant (TorqCmp Delay T)	10		d4-01	-- 4	0	
C5-01	ASR proportional (P) gain 1 (ASR P Gain 1)	20.00 ₁		d4-02	-- 4	25	
C5-02	ASR integral (I) time 1 (ASR I Time 1)	0.500 ₁		E1-01	Input voltage setting (Input Voltage)	200 ₅	
C5-03	ASR proportional (P) gain 2 (ASR P Gain 2)	20.00 ₁		E1-02	Motor selection (Motor Selection)	0	
C5-04	ASR integral (I) time 2 (ASR I Time 2)	0.500 ₁		E1-03	V/f pattern selection (V/F Selection)	0F	
C5-05	ASR limit (ASR Limit)	5.0		E1-04	Max. output frequency (Max Frequency)	60.0	
C5-06	ASR primary delay time (ASR Delay Time)	0.004		E1-05	Max. voltage (Max Voltage)	200.0 ₅	
C5-07	ASR switching frequency (ASR Gain SW Freq)	0.0		E1-06	Base frequency (Base Frequency)	60.0	
C5-08	ASR integral (I) limit ² (ASR I Limit)	400		E1-07	Mid. output frequency (Mid. Frequency A)	3.0 ₁	
C6-01	Carrier frequency upper limit (Carrier Freq Max)	15.0 ₃		E1-08	Mid. output frequency voltage (Mid Voltage A)	11.0 _{1 5}	
C7-01	Hunting prevention selection (Hunt Prev Select)	1		E1-09	Min. output frequency (Min Frequency)	0.5 ₁	
C7-02	Hunting prevention gain (Hunt Prev Gain)	1.00		E1-10	Min. output frequency voltage (Min Voltage)	2.0 _{1 5}	
C8-08	AFR gain (AFR Gain)	1.00		E1-11	Mid. output frequency 2 ² (Mid. Frequency B)	0.0	
C8-09	Speed feedback detection control (AFR) time*2 (AFR Time)	50		E1-12	Mid. output frequency voltage 2 ² (Mid Voltage B)	0.0	
C8-30	Carrier frequency during autotuning ² (Carrier in tune)	2		E1-13	Base voltage ² (Base Voltage)	0.0	
d1-01	Frequency reference 1 (Reference 1)	0.00		E2-01	Motor rated current (Motor Rated FLA)	1.90 ₃	
d1-02	Frequency reference 2 (Reference 2)	0.00		E2-02	Motor rated slip (Motor Rated Slip)	2.90 ₃	
d1-03	Frequency reference 3 (Reference 3)	0.00		E2-03	Motor no-load current (No-Load Current)	1.20 ₃	
d1-04	Frequency reference 4 (Reference 4)	0.00		E2-04	Number of motor poles (Number of Poles)	4	
d1-05	Frequency reference 5 (Reference 5)	0.00		E2-05	Motor line-to-line resistance (Term Resistance)	9.842 ₃	
d1-06	Frequency reference 6 (Reference 6)	0.00		E2-06	Motor leak inductance (Lead Inductance)	18.2 ₃	
d1-07	Frequency reference 7 (Reference 7)	0.00		E2-07	Motor iron-core saturation coefficient 1 (Saturation Comp 1)	0.50	
d1-08	Frequency reference 8 (Reference 8)	0.00		E2-08	Motor iron-core saturation coefficient 2 (Saturation Comp 2)	0.75	
d1-09	Jog frequency reference (Jog Reference)	6.00		E2-09	Motor mechanical loss (Mechanical Loss)	0.0	
d2-01	Frequency reference upper limit (Ref Upper Limit)	100.0		E3-01	Motor 2 control method selection ² (Control Method)	2	
d2-02	Frequency reference lower limit (Ref Lower Limit)	0.0		E4-01	Motor 2 max. output frequency ² (V/F2 Max Freq)	60.0	
d3-01	Jump frequency 1 (Jump Freq 1)	0.0		E4-02	Motor 2 max. voltage ² (V/F2 Max Voltage)	200.0 ₅	
d3-02	Jump frequency 2 (Jump Freq 2)	0.0		E4-03	Motor 2 max. voltage frequency ² (V/F2 Base Freq)	60.0	
d3-03	Jump frequency 3 (Jump Freq 3)	0.0		E4-04	Motor 2 mid. output frequency 1 ² (V/F2 Mid Freq)	3.0	

* 1. Factory setting depends on the control method (A1) 02.

* 2. Not displayed for some models depending on software version No.

* 3. Setting unit and initial setting depend on Inverter capacity.

* 4. Constants that cannot be used. (Do not change the settings)

* 5. Setting for 200 V class Inverters. For 400 V class Inverters, double the value.

Table 12.1 User Constants (Continued)

No.	Name (Display)	Factory Setting	Setting	No.	Name (Display)	Factory Setting	Setting
E4-05	Motor 2 mid. output frequency voltage ¹ (V/F2 Mid Voltage)	11.0 2		F5-02	Channel 2 output selection (DO-02 Ch2 Select)	1	
E4-06	Motor 2 min. output frequency (V/F2 Min Freq)	0.5		F6-01	Output mode selection (DO-08 Selection)	0	
E4-07	Motor 2 min. output frequency voltage ¹ (V/F2 Min Voltage)	2.0 2		F7-01	Frequency multiple selection (PO-36F Selection)	1	
E5-01	Motor 2 rated current ¹ (Motor 2 rated FLA)	1.9 3		F8-01	Transmission option (SI-F/G) ¹ (E-15 Det Sel)	1	
E5-02	Motor 2 rated slip ¹ (Motor 2 Slip Freq)	2.90 3		F9-01	External fault input level from transmission option (FPO Selection) ¹	0	
E5-03	Motor 2 no-load current ¹ (Motor 2 No-load I)	1.20 3		F9-02	External fault detection from transmission option (EFO Selection) ¹	0	
E5-04	Motor 2 number of poles ¹ (Motor 2 # Poles)	4 poles		F9-03	Action for external fault from transmission option (EFO Fault Act) ¹	1	
E5-05	Motor 2 line-to-line resistance ¹ (Motor 2 term Ohms)	9.842 3		F9-04	Transmission option trace sampling time (Trace Sample Time) ¹	0	
E5-06	Motor 2 leak inductance ¹ (Motor 2 Leak)	18.2 3		H1-01	Multi-function input (terminal 3) (Terminal 3 Sel)	24	
F1-01	PG constant (PG Pulse/Rev)	600		H1-02	Multi-function input (terminal 4) (Terminal 4 Sel)	14	
F1-02	Operation selection at PG open circuit (PG Fdbk Loss Sel)	1		H1-03	Multi-function input (terminal 5) (Terminal 5 Sel)	3 (0) 5	
F1-03	Operation selection at overspeed (PG Overspeed Sel)	1		H1-04	Multi-function input (terminal 6) (Terminal 6 Sel)	4 (3) 5	
F1-04	Operation selection at deviation (PG Deviation Sel)	3		H1-05	Multi-function input (terminal 7) (Terminal 7 Sel)	6 (4) 5	
F1-05	PG rotation (PG Rotation Sel)	0		H1-06	Multi-function input (terminal 8) (Terminal 8 Sel)	8 (6) 5	
F1-06	PG division rate (PG pulse monitor) (PG output Ratio)	1		H2-01	Multi-function input (terminal 9-10) (Terminal 9 Sel)	0	
F1-07	Integral value during accel/decel enable/disable (PG Ramp P11 Sel)	0		H2-02	Multi-function input (terminal 25-27) (Terminal 25 Sel)	1	
F1-08	Overspeed detection level (PG Overspd Level)	115		H2-03	Multi-function input (terminal 26-27) (Terminal 26 Sel)	2	
F1-09	Overspeed detection delay time (PG Overspd Time)	0.0 4		H3-01	Signal level selection (terminal 13) (Term 13 Signal)	0	
F1-10	Excessive speed deviation detection level (PG Deviate level)	10		H3-02	Gain (terminal 13) (Terminal 13 Gain)	100.0	
F1-11	Excessive speed deviation detection delay time (PG Deviate Time)	0.5		H3-03	Bias (terminal 13) (Terminal 13 Bias)	0.0	
F1-12	Number of PG gear teeth 1 (PG# Gear Teeth 1)	0		H3-04	Signal level selection (terminal 16) (Term 16 Signal)	0	
F1-13	Number of PG gear teeth 2 (PG# Gear Teeth 2)	0		H3-05	Multi-function analog input (terminal 16) (Terminal 16 Sel)	0	
F1-14	PG open-circuit detection time ¹ (PGO Time)	2.0		H3-06	Gain (terminal 16) (Terminal 16 Gain)	100.0	
F2-01	Bi-polar or uni-polar input selection (AI-14 Input Sel)	0		H3-07	Bias (terminal 16) (Terminal 16 Bias)	0.0	
F3-01	Digital input option (DI Input)	0		H3-08	Signal level selection (terminal 14) (Term 14 Signal)	2	
F4-01	Channel 1 monitor selection (AO Ch1 Select)	2		H3-09	Multi-function analog input (terminal 14) (Terminal 14 Sel)	1F	
F4-02	Channel 1 gain (AO Ch1 Gain)	100.0		H3-10	Gain (terminal 14) (Terminal 14 Gain)	100.0	
F4-03	Channel 2 monitor selection (AO Ch2 Select)	3		H3-11	Bias (terminal 14) (Terminal 14 Bias)	0.0	
F4-04	Channel 2 gain (AO Ch2 Gain)	0.50		H3-12	Analog input filter time constant (Filter Avg Time)	0.00	
F4-05	Channel 1 output monitor bias (AO Ch1 Bias)	0.0		H4-01	Monitor selection (terminal 21) (Terminal 21 Sel)	5	
F4-06	Channel 2 output monitor bias (AO Ch2 Bias)	0.0		H4-02	Gain (terminal 21) (Terminal 21 Gain)	1.00	
F5-01	Channel 1 output selection (DO-02 Ch1 Select)	0		H4-03	Bias (terminal 21) (Terminal 21 Bias)	0.0	

* 1. Not displayed for some models depending on software version No.

* 2. Setting for 200 V class Inverters. For 400 V class Inverters, double the value.

* 3. Setting unit and initial setting depend on Inverter capacity.

* 4. Depends on the control method (A1-02).

* 5. Factory setting in the parentheses is for 3-wire sequence.

Table 12.1 User Constants (Continued)

No.	Name (Display)	Factory Setting	Setting	No.	Name (Display)	Factory Setting	Setting
H4-04	Monitor selection (terminal 23) (Terminal 23 Sel)	18		L6-02	Torque detection level 1 (Torq Det 1 Lvl)	150	
H4-05	Gain (terminal 23) (Terminal 23 Gain)	0.50		L6-03	Torque detection time 1 (Torq Det 1 Time)	0.1	
H4-06	Bias (terminal 23) (Terminal 23 Bias)	0.0		L6-04	Torque detection selection 2 (Torq Det 2 Lvl)	0	
H4-07	Analog output signal level selection (AO Level Select)	0		L6-05	Torque detection level 2 (Torq Det 2 Lvl)	150	
H5-01	Station address (Serial Comm Adr)	1F		L6-06	Torque detection time 2 (Torq Det 2 time)	0.1	
H5-02	Communication speed selection (Serial Baud Rate)	3		L7-01	Forward torque limit (Torq Limit Fwd)	200	
H5-03	Communication parity selection (Serial Com Sel)	0		L7-02	Reverse torque limit (Torq Limit Rev)	200	
H5-04	Stopping method after communication error (Serial Fault Sel)	3		L7-03	Forward regenerative torque limit (Torq Lmt Fwd Rgn)	200	
H5-05	Communication error detection selection ¹ (Serial Flt Dct)	1		L7-04	Reverse regenerative torque limit (Torq Lmt Rev Rgn)	200	
L1-01	Motor protection selection (MOL Fault Select)	1		L8-01	Protect selection for internal DB resistor (DB Resistor Prot)	0	
L1-02	Motor protection time constant (MOL Time Const)	1.0		L8-02	Overheat pre-alarm level (OH Pre-Alarm Lvl)	95	
L2-01	Momentary power loss detection (Pwrl. Selection)	0		L8-03	Operation selection after overheat pre-alarm (OH Pre-Alarm Sel)	3	
L2-02	Momentary power loss ride thru time (Pwrl. Ride thru t)	0.7 ₂		L8-05	Input open-phase protection selection (Ph Loss In Sel)	0	
L2-03	Min. baseblock time (Pwrl. Baseblock t)	0.5 ₂		L8-07	Output open-phase protection selection (Ph Loss Out Sel)	0	
L2-04	Voltage recovery time (Pwrl. V/F Ramp t)	0.2 ₂		L8-10	Ground protection selection (GND Det Sel)	1	
L2-05	Undervoltage detection level (PUV Det Level)	190 ₃		L8-17	Carrier frequency reduction selection (L-Spd IGBT Prcnt)	1	
L2-06	KEB deceleration rate (KEB Frequency)	0.0		L8-19	OL2 characteristics selection for low speeds (OL2 Chara @ L-Spd)	0	
L3-01	Stall prevention selection during accel (StallP Accel Sel)	1		01-01	Monitor selection (Monitor Select)	6	
L3-02	Stall prevention level during accel (StallP Accel Lvl)	150		01-02	Monitor selection after power up (Power-On Monitor)	1	
L3-03	Stall prevention limit during accel (StallP CHP Lvl)	50		01-03	Frequency units of reference setting/monitor (Display Scaling)	0	
L3-04	Stall prevention selection during decel (StallP Decel Sel)	1		01-04	Frequency units of constant setting (Display Units)	0	
L3-05	Stall prevention selection during running (StallP Run Sel)	1		01-05	Constant no. display selection (Address Display)	0	
L3-06	Stall prevention level during running (StallP Run Level)	160		02-01	LOCAL/REMOTE key enable/disable (Local/Remote Key)	1	
L4-01	Speed agree detection level (Spd Agree Level)	0.0		02-02	STOP key during control circuit terminal operation (Oper STOP Key)	1	
L4-02	Speed agree detection width (Spd Agree Width)	2.0		02-03	User constant initial value (User Defaults)	0	
L4-03	Speed agree detection level (+/-) (Spd Agree Lvl +/-)	0.0		02-04	kVA selection (Inverter Model #)	0 ₂	
L4-04	Speed agree detection width (+/-) (Spd Agree Width +/-)	2.0		02-05	Frequency reference setting method (Operator M.O.P.)	0	
L4-05	Operation when frequency reference is missing (Ref Loss Sel)	0		02-06	Operation selection when digital operator is disconnected (Opel Detection)	0	
L5-01	Number of auto restart attempts (Num of Restarts)	0		02-07	Cumulative operation time setting (Elapsed Time Set)		
L5-02	Auto restart operation selection (Restart Sel)	0		02-08	Cumulative operation time selection (Elapsed Time Run)	0	
L6-01	Torque detection selection 1 (Torq Det 1 Sel)	0		02-09	Initialize mode selection ¹ (Init Mode Sel)	0 ₄	

* 1. Not displayed for some models depending on software version No.

* 2. Setting unit and initial setting depend on Inverter capacity.

* 3. Setting for 200 V class Inverters. For 400 V class Inverters, double the value.

* 4. Not initialized. (Japanese standard specification is o2-09 = 0.)

Table 12.1 User Constants (Continued)

No.	Name (Display)	Factory Setting	Setting	No.	Name (Display)	Factory Setting	Setting
P1-01	Winding Change frequency (Changeover Freq)	0.0		P3-05	Positioning Completion Detection Width (ORE Set Pulse)	5 pulses	
P1-02	Winding change hysteresis (Frequency Width)	0.5		P3-06	Positioning Completion Cancel Width (ORE Reset Pulse)	10 pulses	
P1-03	MC Answerback error detection (Ansback Det Time)	0.20		P3-07	Orientation Speed (ORT Speed)	400 r/min	
P1-04	Motor Constant selection (Wye Winding Sel)	1		P3-08	Gear Ratio (H) (Gear Ratio H)	1.0000	
P1-05	Programming mode valid/invalid during run (Program Mode @ RUN)	1		P3-11	Gear Direction (Gear Direction)	0	
P3-01	Main Axis Zero Point (Position Origin)	0 pulses		P3-12	Dither Level (Dither Level)	0	
P3-02	Position Control Gain (H) (Position Gain H)	10					

上正科技有限公司

購買、維修 此手冊零組件

電話： 037-466333

Email: service@repairtw.com

Line id: @zzzz

www.repairtw.com

A

- AC Reactor 3 - 14
- acceleration 6 - 11 6 - 16
- acceleration/deceleration ramp hold 7 - 33
- access levels 1 - 5 4 - 6 4 - 19 6 - 2
- Advanced 1 - 5 4 - 6
 - setting user constants 4 - 10
- AFR
 - See automatic frequency generator
- analog input characteristics gain and bias 7 - 45
- analog inputs 6 - 5
 - adjusting gain and bias 6 - 6
 - switching 6 - 5
- Analog Monitor Card settings 7 - 28
- Analog Reference Card settings 7 - 27
- ASR
 - See speed loop
- automatic frequency regulator 7 - 5
- autotuning 1 - 4 4 - 29
 - input voltage setting flux vector control 6 - 27
 - open-loop vector control 6 - 17
 - faults 6 - 21
 - setting user constants 6 - 18

B

- Basic 1 - 5 4 - 6
 - setting user constants 4 - 9
- bias analog inputs 6 - 6
- braking resistor 3 - 17
- Braking Resistor Unit 12 - 8
 - connecting 3 - 17
- Braking Unit 12 - 8
 - connecting 3 - 17
 - parallel 3 - 18
- BUS (option communications error) 9 - 7

C

- cables length 3 - 16
- CALL (serial communications call) 9 - 7
- carrier frequency 7 - 24
- CE (MEMOBUS communications error) 9 - 7
- CF (out of control) 9 - 4
- closed-loop connectors
 - control circuit 3 - 28
 - main circuit 3 - 8

- common functions 7 - 17
- communications error (CE) 9 - 7
- connection diagrams 3 - 4 3 - 12
- constants write enable 7 - 36
- contact outputs 12 - 14
- control fault (CF) 9 - 4
- control inputs 6 - 9
 - responsiveness 6 - 9
- control method affects on factory settings 8 - 35
- control methods 4 - 20 6 - 3
- CPF 9 - 4
- cumulative operating time 7 - 63

D

- DC injection braking command 7 - 40
- DC injection braking function 7 - 18
- DDS/SI-B external error detected 9 - 7
- deceleration 6 - 11 6 - 16
 - time switching frequency 6 - 11
 - times 6 - 16
- DEV (speed deviation) 9 - 4 9 - 7
- Digital Operator 1 - 5 1 - 8 5 - 9
 - attaching 2 - 9
- Digital Output Card 7 - 29
- Digital Reference Card settings 7 - 28
- dimensions 2 - 4
- display status 5 - 4

E

- E-15 (Si-F) communications error 9 - 7
- EF (external fault) 9 - 4 9 - 6 9 - 7
- EF0 (option external fault) 9 - 7
- EF0 9 - 4
- electromagnetic switch 3 - 15
- emergency stop 6 - 10 6 - 16
 - time setting 6 - 10
 - time switching frequency 6 - 11
 - times 6 - 16
- enclosed, wall-mounted type 2 - 3
 - installation conditions 2 - 6
- ERR (EEPROM read/write error) 9 - 8
- errors operation 9 - 8
- excessive speed deviation 9 - 4 9 - 7

external baseblock NC 7 - 32
external baseblock NO 7 - 32
external faults 7 - 37
external speed search 1 7 - 40
external speed search 2 7 - 40

F

factory settings 12 - 15
fault reset 7 - 35
fault restart settings 7 - 56
faults 9 - 2
 autotuning
 flux vector control 6 - 31
 open-loop vector control 6 - 21
 detection functions flux vector control 6 - 23
 minor 9 - 6
flux vector control 1 - 4 6 - 22 7 - 10
 PG Speed Control Cards 6 - 22
forward/reverse run commands input together (EF) 9 - 6
frequency detection settings 7 - 53
frequency references 1 - 4 6 - 4 6 - 13 7 - 24
 function selection 6 - 16
 jog 6 - 13
 multi-step 6 - 13
 presetting 6 - 8
 selecting 6 - 4
 selecting the source 6 - 7
 selecting the units 6 - 7
 terminal 13 signal level 6 - 4
 terminal 14 signal level 6 - 4
 terminal 16 signal level 6 - 5
 voltage range 6 - 4
front cover
 mounting 2 - 9
 removing 2 - 8 2 - 9

G

gain analog inputs 6 - 6
GF (ground fault) 9 - 2
ground wiring 3 - 16
ground fault (GF) 9 - 2
ground fault interrupter 3 - 13

H

hardware protection settings 7 - 57

I

IGBT 1 - 4
inductive noise countermeasures 3 - 15
initial excitation function flux vector control 6 - 26
initialize mode 4 - 18
 user constant list 8 - 3
input voltage setting 5 - 5
inrush prevention circuit fault (UV3) 9 - 2
inspection 10 - 3
installation 2 - 7
 conditions 2 - 6
 enclosed, wall-mounted type 2 - 6
 open-chassis type 2 - 6
 site 2 - 6
 space 2 - 7
insulated gate bipolar transistor
 See IGBT
inverter capacity affects on factory settings 8 - 36
inverter overheat pre-alarm 7 - 43
inverter overheating pre-alarm (OH2) 9 - 6

J

jog 6 - 8 6 - 16
jump frequencies 7 - 25

K

key function settings 7 - 61

L

language 4 - 19
LF (output phase loss) 9 - 3
load short-circuit (SC) 9 - 2
local/remote selection 7 - 32

M

magnetic contactor 3 - 13 3 - 15
main circuit
 input side wiring 3 - 13
 output side wiring 3 - 15
main circuit overvoltage (OV) 9 - 6

上正科技有限公司
購買、維修 此手冊零組件
電話： 037-466333
Email: service@repairtw.com
Line id: @3333
www.repairtw.com

- main circuit terminals 3 - 6
 - main circuit undervoltage (UV) 9 - 6
 - main circuit undervoltage (UV1) 9 - 2
 - main circuit voltage fault (PF) 9 - 3
 - maintenance 10 - 3
 - mass 2 - 5
 - MEMOBUS communications 7 - 47
 - modes
 - Inverter 4 - 4
 - switching 4 - 5
 - modified constants mode 4 - 31
 - molded-case circuit breaker 3 - 13
 - momentary power loss settings 7 - 49
 - monitor output adjusting 7 - 46
 - monitoring startup 4 - 16
 - motor
 - using the Inverter for a special motor 12 - 5
 - using the Inverter for a standard motor 12 - 4
 - motor constants 7 - 5
 - motor overload OL1 7 - 43
 - motor protection settings 7 - 48
 - multi-function analog input selection 7 - 34
 - multi-function analog input/frequency reference current 7 - 44
 - multi-function analog output settings 7 - 46
 - multi-function analog output signal level 7 - 46
 - multi-function input functions 8 - 21
 - multi-function input settings 7 - 31
 - multi-function inputs 6 - 12
 - multi-function output functions 8 - 22
 - multi-function output settings 7 - 41
- ## N
- no-load operation 5 - 8
 - Digital Operator 5 - 9
 - frequency reference setting 5 - 8
 - status checking 5 - 9
 - noise filter
 - output side 3 - 15
 - LC/RC 3 - 15
 - power supply side 3 - 14
- ## O
- OC (overcurrent) 9 - 2
 - OH (heat sink over temperature) 9 - 6
 - OH OH1 (heat sink over temperature) 9 - 3
 - OH2 (overheat 2) 9 - 6
 - OH2 alarm signal 7 - 34
 - OL1 (motor overloaded) 9 - 3
 - OL2 (inverter overloaded) 9 - 3
 - OL3 (overtorque detection 1) 9 - 3 9 - 6
 - OL4 (overtorque detection 2) 9 - 3 9 - 6
 - OPE 9 - 8
 - open-chassis type 2 - 3
 - openhassis type installation conditions 2 - 6
 - open-loop vector control 6 - 17 7 - 2
 - open-loop vector control 1 - 4
 - operation mode 4 - 11
 - operator display selection 7 - 60
 - OPR (operator disconnect) 9 - 4
 - Option Card transmission error (BUS) 9 - 7
 - option card/inverter selection 7 - 32
 - Option Cards settings 7 - 26
 - OS (overspeed) 9 - 3 9 - 6
 - output open phase (LF) 9 - 3
 - OV (overvoltage) 9 - 2 9 - 6
 - overcurrent (OC) 9 - 2
 - overspeed 9 - 3 9 - 6
 - flux vector control 6 - 24
 - overtorque 1 (OL3) 9 - 6
 - overtorque 2 (OL4) 9 - 6
 - overtorque detection settings 7 - 56
 - password 4 - 23
 - PF (input phase loss) 9 - 3
 - PG
 - constant flux vector control 6 - 22
 - disconnection stopping method flux vector control 6 - 23
 - flux vector control 6 - 22
 - pulse output monitor division rate flux vector control 6 - 23
 - rotation direction flux vector control 6 - 22
 - speed deviation flux vector control 6 - 24
 - PG disconnection detection 9 - 4
 - PG Speed Control Card 6 - 22
 - installing 3 - 24

- terminal blocks 3 - 25
 - wiring 3 - 28
 - wiring 3 - 26
- PGO (PG open) 9 - 4 9 - 6
- phase advancing capacitor 3 - 15
- power supplies 5 - 4
 - input connecting 3 - 13
- power transmission mechanism 12 - 5
- programming mode 4 - 26
 - parameter list 8 - 4
- PUF (DC bus fuse open) 9 - 2
- Pulse Monitor Card settings 7 - 30

Q

- Quick-start 4 - 6
 - setting user constants 4 - 8
- Quick-start 1 - 5

R

- radio noise countermeasures 3 - 16
- reference source 6 - 4
- reverse operation 6 - 11
- RH (dynamic brake resistor) 9 - 3
- RR (dynamic brake resistor) 9 - 3
- run 6 - 9
 - command 6 - 9
 - source 6 - 9

S

- S-curve characteristic function 7 - 21
- SC (short circuit) 9 - 2
- sequence control 3-wire 6 - 13
- sequential operation 4 - 21
- settings
 - analog output bias (terminal 21) H4-03 6 - 34
 - analog output bias (terminal 23) H4-06 6 - 34
 - analog output gain (terminal 21) H4-02 6 - 34
 - analog output gain (terminal 23) H4-05 6 - 34
 - analog output level selection H4-07 6 - 34
 - analog output selection (terminal 21) H4-01 6 - 34
 - analog output selection (terminal 23) H4-04 6 - 34
- SI-B communications error 9 - 7
- SI-F/G communications error detected 9 - 7
- slip compensation gain 7 - 15 7 - 22
- specifications Inverters 11 - 2

- speed control
 - flux vector control 6 - 32
 - integral time
 - flux vector control 6 - 32
 - low-speed gain 6 - 32
 - proportional gain
 - flux vector control 6 - 32
 - low-speed gain 6 - 32
 - responsiveness flux vector control 6 - 33
- speed control gain flux vector control 6 - 34
- fine adjustments 6 - 34
- speed control integral reset 7 - 34
- speed control proportional gain 7 - 41
- speed feedback 7 - 5
- speed search function 7 - 20
- stall prevention function settings 7 - 51
- Status Monitor 4 - 12
- stopping method 6 - 12
 - deceleration 6 - 12
 - flux vector control 6 - 25
- surge absorber 3 - 14

T

- temperature 2 - 6
- terminal block 3 - 5
- torque compensation function 7 - 23
- torque limits 7 - 3 7 - 11
 - analog inputs 7 - 4 7 - 11
- Transmission Option Card DPRAM error (CPF23) 9 - 5
- Transmission Option Card model code error (CPF22) 9 - 5
- Transmission Option Card self diagnostic error (CPF21) 9 - 5
- trim control increase and decrease 7 - 36
- troubleshooting 9 - 1 9 - 9
- up and down commands 7 - 34
- user constants 4 - 23
 - application constants 8 - 4
 - autotuning
 - acceleration/deceleration 8 - 7
 - carrier frequency 8 - 10
 - factory tuning 8 - 11
 - motor slip compensation 8 - 8
 - S-curve acceleration/deceleration 8 - 8
 - speed control 8 - 10
 - torque compensation 8 - 9
 - autotuning constants 8 - 7

- constants with factory settings dependent on control method 8 - 35
- constants with factory settings dependent on inverter capacity 8 - 36
- DC braking 8 - 5
- factory settings 12 - 15
- initializing 4 - 21
- lists
 - initialize mode 8 - 3
 - programming mode 8 - 4
- motor constants 8 - 14
 - motor 2 control method 8 - 16
 - motor 2 setup 8 - 17
 - motor 2 V/f pattern 8 - 16
 - motor setup 8 - 15
 - V/f pattern 8 - 14
- operation mode selections 8 - 4
- operator constants 8 - 32
 - monitor selections 8 - 32
 - multi-function selections 8 - 33
- options 8 - 18
 - other option setup 8 - 19
 - PG option setup 8 - 18
- protection constants 8 - 26
 - fault restart 8 - 29
 - hardware protection 8 - 30
 - motor overload 8 - 26
 - power loss ride-through 8 - 26
 - reference directions 8 - 28
 - stall prevention 8 - 27
 - torque detection 8 - 29
 - torque limits 8 - 30
- reference constants 8 - 12
 - jump frequencies 8 - 13
 - preset references 8 - 12
 - reference limits 8 - 12
 - search speed 8 - 6
- setting
 - Advanced 4 - 10
 - Basic 4 - 9
 - Quick-start 4 - 8
- terminal constants 8 - 21
- analog inputs 8 - 23
- analog outputs 8 - 25
- MEMOBUS communications 8 - 25

- multi-function inputs 8 - 21
- multi-function outputs 8 - 22
- UV (DC bus undervoltage) 9 - 6
- UV1 (DC bus undervoltage) 9 - 2
- UV2 (CTL PS undervoltage) 9 - 2
- UV3 (MC answerback) 9 - 2

V

- motor constants 7 - 13
- vector control 1 - 4
 - flux 1 - 4
 - open-loop 1 - 4
- ventilation 2 - 6
- voltage 5 - 5 6 - 27
 - input 5 - 5
 - autotuning in flux vector control 6 - 27
- voltage range 6 - 4
 - frequency reference 6 - 4
- VS Operator 12 - 13

W

- warning label v viii
- wire sizes 3 - 6
 - control circuits 3 - 20
- wiring
 - connection diagrams 3 - 12
 - control circuit 3 - 20
- write-protect 4 - 23
- zero-speed 7 - 43
- zero-speed operation flux vector control 6 - 25

Z

上正科技有限公司
購買、維修 此系列零組件
電話： 037-466333
Email: service@repairtw.com
Line id: @zzzz

www.repairtw.com

VARISPEED-626MC5 INSTRUCTION MANUAL

TOKYO OFFICE

New Piar Takeshiba South Tower, 1-16-1, Kaigan, Minato-ku, Tokyo 105-0022 Japan
Phone 81-3-5402-4511 Fax 81-3-5402-4580

YASKAWA ELECTRIC AMERICA, INC.

Chicago-Corporate Headquarters
2942 MacArthur Blvd, Northbrook, IL 60062-3028, U.S.A.
Phone 1-847-291-2340 Fax 1-847-455-2430

Chicago-Technical Center
3160 MacArthur Blvd, Northbrook, IL 60062-1917, U.S.A.
Phone 1-847-291-0411 Fax 1-847-291-1918

MOTOMAN INC. HEADQUARTERS

805 Liberty Lane West Carrollton, OH 45449, U.S.A.
Phone 1-937-847-6200 Fax 1-937-847-6277

YASKAWA ELÉTRICO DO BRASIL COMÉRCIO LTDA.

Avenida Fagundes Filho, 620 Bairro Saude-Sao Paulo-SP, Brazil CEP: 04304-000
Phone 55-11-6071-2552 Fax 55-11-5581-8796

YASKAWA ELECTRIC EUROPE GmbH

Am Kronberger Hang 2, 65824 Schwalbach, Germany
Phone 49-6196-569-300 Fax 49-6196-588-301

Motoman Robotics AB

Box 504 536325 Torshä, Sweden
Phone 46-486-48800 Fax 46-486-41410

Motoman Robotec GmbH

Kammerfeldstraße 1, 85391 Allershausen, Germany
Phone 49-8166-900 Fax 49-8166-9039

YASKAWA ELECTRIC UK LTD.

1 Hunt Hill Orchardton Woods Cumbernauld, G68 9LF, United Kingdom
Phone 44-1236-735000 Fax 44-1236-458182

YASKAWA ELECTRIC KOREA CORPORATION

Kipsa Bldg #1201, 35-4 Youido-dong, Yeongdeungpo-Ku, Seoul 150-010, Korea
Phone 82-2-794-7844 Fax 82-2-794-8495

YASKAWA ELECTRIC (SINGAPORE) PTE. LTD.

151 Lorong Chuan, #04-01, New Tech Park, Singapore 556741, Singapore
Phone 65-282-3003 Fax 65-289-3003

YATEC ENGINEERING CORPORATION

Shen Hsiang Tang Sung Chiang Building 10F 146 Sung Chiang Road, Taipei, Taiwan
Phone 886-2-2563-0010 Fax 886-2-2567-4677

BEIJING OFFICE

Room No. 301 Office Building of Beijing International Club, 21
Jianguomenwai Avenue, Beijing 100020, China
Phone 86-10-6532-1850 Fax 86-10-6532-1851

SHANGHAI OFFICE

27 Hui He Road Shanghai 200437 China
Phone 86-21-6553-6600 Fax 86-21-6531-4242

YASKAWA JASON (HK) COMPANY LIMITED

Rm. 2909-10, Hong Kong Plaza, 186-191 Connaught Road West, Hong Kong
Phone 852-2903-2365 Fax 852-2547-5773

TAIPEI OFFICE

Shen Hsiang Tang Sung Chiang Building 10F 146 Sung Chiang Road, Taipei, Taiwan
Phone 886-2-2563-0010 Fax 886-2-2567-4677

SHANGHAI YASKAWA-TONGJI M & E CO., LTD.

27 Hui He Road Shanghai China 200437
Phone 86-21-6531-4242 Fax 86-21-6553-6060

BEIJING YASKAWA BEIKE AUTOMATION ENGINEERING CO., LTD.

30 Xue Yuan Road, Haidian, Beijing P.R. China Post Code: 100083
Phone 86-10-6233-2782 Fax 86-10-6232-1536

SHOUGANG MOTOMAN ROBOT CO., LTD.

7, Yongchang-North Street, Beijing Economic Technological Investment & Development Area,
Beijing 100076, P.R. China
Phone 86-10-6788-0551 Fax 86-10-6788-2878



YASKAWA

YASKAWA ELECTRIC CORPORATION